

HUGO GERNSBACH, E.

RADIO CRAFT

ELECTRONIC
EGG GRADER
SEE PAGE 22



In this issue -

- Signal Injection Servicing
- Postwar Phonograph Pickups
- Mobile 144-Mc Transmitter

SEPT
1947

25¢
CANADA 30¢

RADIO-ELECTRONICS IN ALL ITS PHASES

Presenting the **NEW MODEL SX-43**

...to give amateurs:

**MORE
VALUE**

Never before all these features at this price

**GREATER
PERFORMANCE**

AM-FM-CW ... all essential amateur frequencies from 540 kc. to 108 Mc.

LOWER PRICE

\$169⁵⁰

Sets available after August 1947

**Built in the
Hallicrafters
Classic
Tradition**

The new SX-43 is built in the Hallicrafters classic tradition: providing custom quality, precision engineering, excellent performance and wide frequency range at a medium price. The SX-43 offers continuous coverage from 540 kc. to 55 Mc. and has an additional band from 88 to 108 Mc. AM reception all bands. CW on four lower bands and FM on frequencies above 44 Mc.

New LOW PRICE Transmitter



\$69⁵⁰

**MODEL
HT-17**

- Ham bands from 3.5 to 30 Mc.
- 15 watts power output on low frequency bands.

Here's real Hallicrafters transmitter performance with maximum convenience and economy. A pi-section matching network, as well as a link, provides coupling to any type of antenna or permits the HT-17 to be used as an exciter for a high power final amplifier. Coil sets extra.

Added technical details on all these models in Hallicrafters New Catalog, No. 38. Ask your local distributor for a copy.

NEW BETTER QUALITY AM WITH NARROW BAND FM

Exclusively designed—**VARIABLE MASTER OSCILLATOR \$110.00**
(amateur net)

Here is the hottest transmitter item available today. Packed with outstanding features never before available in one low-priced unit. Add to the HT-18 one or two amplifier stages and you have a complete, high quality transmitter permitting operation on phone or CW up to 1 KW.

MODEL HT-18



Narrow band FM ... direct frequency calibration ... finger-tip control of entire station ... full frequency deviation on all ham bands to 29.7 Mc. ... only 1/10 the distortion of comparable units ... excellent stability ... clean keying ...

BUILDERS OF *Skystone* AVIATION RADIOTELEPHONE

hallicrafters RADIO

THE HALLICTRAFTERS CO., MANUFACTURERS OF RADIO AND ELECTRONIC EQUIPMENT, CHICAGO 16, U. S. A.

Sole Hallicrafters Representatives in Canada: Rogers Majestic Limited, Toronto-Montreal



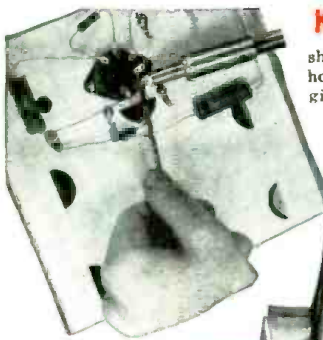

KIT 1 (left) I send you Soldering Equipment and Radio Parts; show you how to do Radio Soldering; how to mount and connect Radio parts; give you practical experience.



KIT 2 (left) Early in my course I show you how to build this N. R. I. Tester with parts I send. It soon helps you fix neighborhood Radios and earn EXTRA money in spare time.



VETERANS

You can get this training in your own home under G. I. Bill. Mail coupon for full details.

Be a **RADIO Technician**
Learn by **PRACTICING** in Spare Time

KIT 3

You get parts to build Radio Circuits; then test them; see how they work, learn how to design special circuits; how to locate and repair circuit defects.



KIT 4

You get parts to build this Vacuum Tube Power Pack; make changes which give you experience with packs of many kinds; learn to correct power troubles.

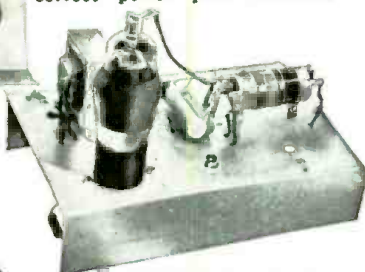

KIT 5 Building this A. M. Signal Generator gives you more valuable experience. It provides amplitude-modulated signals for many tests and experiments.



KIT 6 You build this Superheterodyne Receiver which brings in local and distant stations—and gives you more experience to help you win success in Radio.

My Course Includes Training in **TELEVISION • ELECTRONICS**
FREQUENCY MODULATION

with **BIG KITS** of **RADIO PARTS** I send you

Do you want a good-pay job in the fast-growing Radio Industry—or your own Radio Shop? Mail the Coupon for a Sample Lesson and my 64-page book, "How to Be a Success in Radio-Television-Electronics," both FREE. See how I will train you at home—how you get practical Radio experience building, testing Radio circuits with **BIG KITS OF PARTS** I send!

Many Beginners Soon Make Extra Money in Spare Time While Learning

The day you enroll I start sending EXTRA MONEY manuals that show how to make EXTRA money fixing neighbors' Radios in spare time while still learning! It's probably easier to get started now than ever before because the Radio Repair Business is booming. Trained Radio Technicians also find profitable opportunities in Police, Aviation, Marine Radio, Broadcasting, Radio Manufacturing, Public Address work. Think of even greater opportunities as Television, FM, and Electronic devices become available to the public! Send for FREE books now!



J. E. SMITH, President National Radio Institute

Find Out What NRI Can Do For You

Mail Coupon for Sample Lesson and my FREE 64-page book. Read the details about my Course; letters from men I trained; see how quickly; easily you can get started. No obligation! Just MAIL COUPON NOW in an envelope or paste it on a penny postal. J. E. SMITH, President, Dept. 7JX, National Radio Institute, Pioneer Home Study Radio School, Washington 9, D. C.

Our 33rd Year of Training Men for Success in Radio

Sample Lesson **FREE**
64 Page Book

Mr. J. E. SMITH, President, Dept. 7JX
National Radio Institute,
Washington 9, D. C.

Mail me FREE Sample Lesson and 64-page book about how to win success in Radio and Television-Electronics. (No salesman will call. Please write plainly.)

Name Age.....
Address
City State.....
(Please include Post Office zone number)

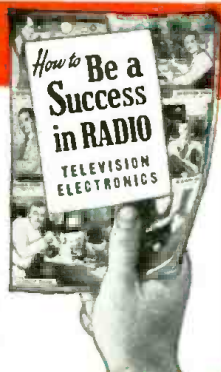

Approved for Training under GI Bill

SYLVANIA NEWS

RADIO SERVICE EDITION

SEPT.

Prepared by SYLVANIA ELECTRIC PRODUCTS INC., Emporium, Pa.

1947

SYLVANIA PRESENTS: Personal Business Forms and Stationery for Time- and Money-Saving EFFICIENCY!

The special business forms shown on this page are items essential to a carefully planned, systematic radio service shop. Sylvania's aim in the prepara-

tion of this material was simply this: to offer radio servicemen the advantages of these time- and money-saving helps at the lowest possible cost.

Efficient Business Record Book—
simplified for accurate daily records
and tax information. Only \$1.00.

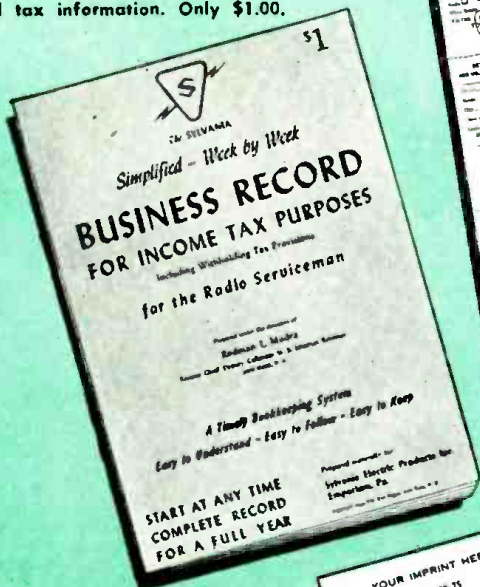

Personal Cards—essential
to all businessmen
(with your imprint):
250—\$.75; 500—\$1.00.



Job Record Cards (with
your imprint)—customer's
record and receipt for cash
payment; and a complete
job record for your files.
100—\$1.00; 250—\$1.75;
500—\$3.00.

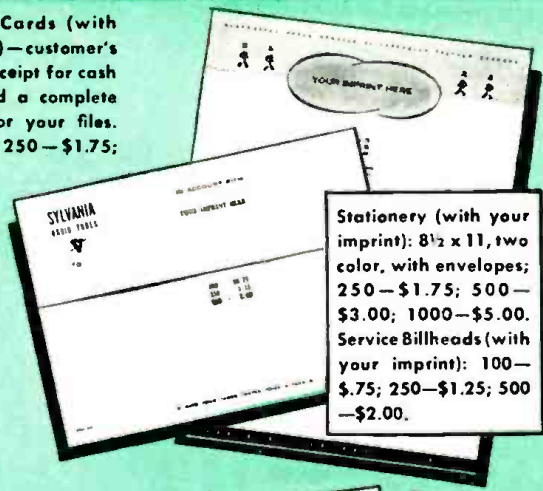
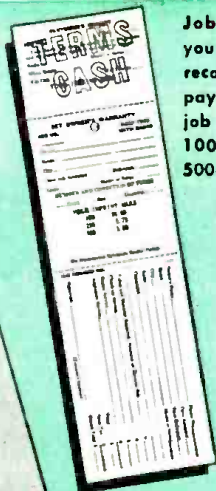

Stationery (with your
imprint): 8½ x 11, two
color, with envelopes;
250—\$1.75; 500—
\$3.00; 1000—\$5.00.
Service Billheads (with
your imprint): 100—
\$.75; 250—\$1.25; 500
—\$2.00.

Three-In-One Service
Form (with your im-
print): Complete job re-
cord for your files; cus-
tomer's invoice and
guarantee, and follow-
up cards; all in one
handy form, perforated
for easy use. 100—
\$1.50; 250—\$2.50; 500
—\$4.00.

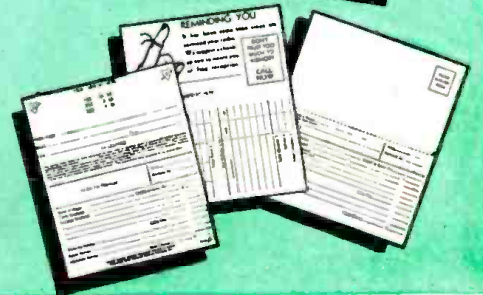

Now is the time to stock up. While you're using these neat, impressive forms and stationery on the home front, Sylvania's extensive advertising—in Life, Collier's, Saturday Evening

Post—is boosting you, your products and your service from coast to coast! To profit from this national sales campaign, use the tested personal sales aids shown.

Order from Sylvania Distributors or write Sylvania Electric Products Inc., Emporium, Pa.

SYLVANIA ELECTRIC

MAKERS OF RADIO TUBES, CATHODE RAY TUBES, ELECTRONIC DEVICES, FLUORESCENT LAMPS, FIXTURES, WIRING DEVICES, ELECTRIC LIGHT BULBS

IMPORTANT ANNOUNCEMENT to my Servicemen friends:

In just one year, PHOTOFACT has become the leading Radio Data Service. I owe this success to you. Your support has made it possible for the SAMS organization to provide you with the most complete, accurate and uniform service information ever published. Your backing has encouraged us to extend our activities. As part of our continuous program in behalf of the Servicing profession, I am happy to announce two important new publications. Like PHOTOFACT Folders, they meet a real need—you've told us so. And like PHOTOFACT, these new publications are based on our own actual study of the equipment covered. I am confident these new books will help your business . . . To each and every one of you I say a heartfelt "Thanks!"

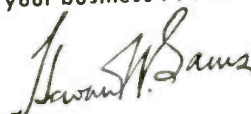

NEW! HOWARD W. SAMS DIAL CORD STRINGING GUIDE

Only Book of its Kind!



There's only one *right* way to string a dial cord. And there's only one book that shows you how. It's the Howard W. Sams DIAL CORD STRINGING GUIDE. Here, for the first time, in one pocket-sized book, are complete dial cord diagrams and data covering 1938 through 1946 receivers. Actually, there are many ways you can go about stringing a dial cord—but only one is *right*. You know from your own experience that if you get started the wrong way, you can waste hours of your valuable time and work yourself into a nervous lather. You can say "goodbye" to wasted time when you have a SAMS DIAL CORD STRINGING GUIDE. It ticks the knottiest dial cord problem in a matter of minutes. This low-cost book is a "must" for servicing. You'll want two copies—one for your tool kit and one for your shop bench.

ONLY
75¢

Handy pocket size
Over 96 pages

Easy to read
diagrams and data

ORDER YOUR COPIES TODAY!

NEW! HOWARD W. SAMS 1947 AUTOMATIC RECORD CHANGER MANUAL

There's Nothing Like It!

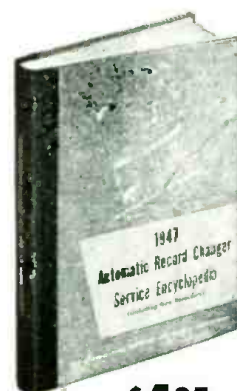

COVERS MORE THAN 40 DIFFERENT POST-WAR MODELS! A DeLuxe volume, packed with ORIGINAL data based on actual study of the equipment covered. Absolutely accurate, complete, authoritative. No other information like it available: Shows exclusive "exploded" views; photos of top, side, bottom and rear views. Tells you manufacturers who use the equipment. Gives full change-cycle data. Complete information on all adjustments. Invaluable Service hints and kinks. Shows complete parts lists keyed to diagrams and photos. Uniform treatment for each piece of equipment. PLUS—for the first time in any publication—complete, accurate service data on leading WIRE, TAPE, AND DISC RECORDERS! No modern service shop can afford to be without this book!

ONLY **\$4.95**

416 pages • Hard Cover
Smythe-sewed—opens flat
Hundreds of photographs
and diagrams

ORDER YOUR COPY TODAY!

New Aids Make PHOTOFACT FOLDERS More Useful Than Ever!



They're yours for the asking: **PHOTOFACT CUMULATIVE INDEX**—Complete Index to first 20 Sets of PHOTOFACT Folders; your guide to more than 1800 receiver models and chassis (1946 and 1947 models). **HOW TO FILE FOLDER**—shows 5 good ways to file PHOTOFACT Folders, including new "30-Second" filing method. Ask your parts jobber for FREE copies of these PHOTOFACT aids, or write us direct.



SETS NO. 22 AND NO. 23 } 160 pages of valuable, needed data covering
NOW AVAILABLE! } current models. Same low price of \$1.50 per set.

HOWARD W. SAMS & CO., INC.
INDIANAPOLIS 6, INDIANA

Export—Ad. Auriema—89 Broad St., New York 4, N. Y.—U. S. of America
Canada—A. C. Simmonds & Sons, 301 King St., East—Toronto, Ontario

PHOTOFACT SERVICE

"The Service that pays for itself over and over again"

MAIL THIS ORDER FORM TO YOUR PARTS JOBBER TODAY—or send directly to HOWARD W. SAMS & CO., Inc., 2924 E. Washington St., Indianapolis 6, Ind.

My (check) (money order) for \$..... enclosed.

- Send . . . SAMS' DIAL CORD STRINGING GUIDE(S), at \$0.75 per copy.
- Send . . . SAMS' 1947 AUTOMATIC RECORD CHANGER MANUAL(S), at \$4.95 per copy.
- Send PHOTOFACT Set No. 22 (at \$1.50).
- Send PHOTOFACT Set No. 23 (at \$1.50).
- Send PHOTOFACT Volume No. 1 (including Sets Nos. 1 through 10) with DeLuxe Binder, \$18.39.
- Send PHOTOFACT Volume No. 2 (including Sets Nos. 11 through 20) with DeLuxe Binder, \$18.39.
- Send FREE Cumulative Index.
- Send FREE "How to File" Folder.

Name

Address

City.....State.....

\$175 AND 25 MONOSETS GIVEN

To Winners of This EASY CONTEST!

RADIO AMATEURS

Just write 50 words or less telling us why you like the TELEX MONOSET better than old style earphones.



WIN:

\$100

and a MonoSet

\$50

and a MonoSet

\$25

and a MonoSet

PLUS

TELEX MONOSETS
to 22 Runner-ups!

HERE'S ALL YOU DO:

1. Go to your *parts jobber* and ask him to let you try out the revolutionary under-the-chin TELEX MONOSET.
2. In 5 minutes you'll get at least half a dozen good, WINNING ideas. Be sure to get *all* the facts and an OFFICIAL ENTRY BLANK.
3. Then write 50 words or less telling us "Why the TELEX MONOSET is

Better than Old-Style Earphones." Clearness and sincerity will count most.

4. Print or type your answer on the OFFICIAL ENTRY BLANK your jobber will give you.

Mail direct to: TELEX, INC., Telex Park, Minneapolis 1, Minnesota, before Midnight October 15, 1947.

FIRST PRIZE: \$100.00 cash and a TELEX MONOSET
SECOND PRIZE: \$ 50.00 cash and a TELEX MONOSET
THIRD PRIZE: \$ 25.00 cash and a TELEX MONOSET

TELEX MONOSETS to the 22 next best opinions. In case of a tie, *duplicate* prizes will be awarded.

Employees of Telex, Inc. and their advertising agency not eligible to enter this contest.

NO BOX TOPS!
NO JINGLES!
Get Entry Blank
From Your Parts
Jobber

CONTEST CLOSING MIDNIGHT OCTOBER 15, 1947!

TIPS TO GET STARTED WITH:

1. TELEX MONOSET is quickly replacing old-style, cumbersome headsets because you wear it under-the-chin instead of over-the-head.
2. Featherweight: Only 1.2 oz. No ear fatigue.
3. Excellent fidelity. Clear, natural reception of sound.
4. Reliable performance assured by TELEX precision engineering.
5. Exclusive, TELEX designed, volume control—permits individual adjustment of volume.

.....
Decision of impartial judges will be final. All entries become property of Telex, Inc. Winners will be notified by mail approximately November 1, 1947. Contest subject to all state and federal regulations.

*Remember, wherever a headset is used—
TELEX MONOSET will do the job better.*





If you want to
LEARN RADIO
 I offer you the finest,
 most practical training
AT LOWEST COST!

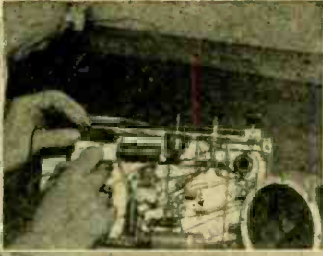

I TRAIN YOUR MIND BY PUTTING YOUR HANDS TO WORK!
 You Get 8 Big Kits of Radio Parts and Equipment, Including a Two-band 6 Tube Super Receiver! 16-Range Meter for Testing!

**INVESTIGATE
 SPRAYBERRY TRAINING
 FOR YOUR OWN GOOD!**
MAIL COUPON FOR 2 FREE BOOKS!



SPRAYBERRY ACADEMY OF RADIO
 F. L. Sprayberry, President
 Room 2097, Pueblo, Colorado

Please rush my FREE copies of "How to MAKE MONEY in RADIO, ELECTRONICS and TELEVISION" and "How to READ RADIO DIAGRAMS and SYMBOLS."

Name _____ Age _____

Address _____

City _____ State _____

(Mail in envelope or paste on penny postcard)

Read what graduate says: "One job nets about \$26"

"Since last week I fixed 7 radios, all good-paying jobs, and right now I am working on an amplifier system. This job alone will net me about \$26.00. As long as my work keeps coming in this way, I have only one word to say and that is 'Thanks' to my Sprayberry training and I am not afraid to boast about it." ADRIEN BENJAMIN, North Grosvenordale, Conn.

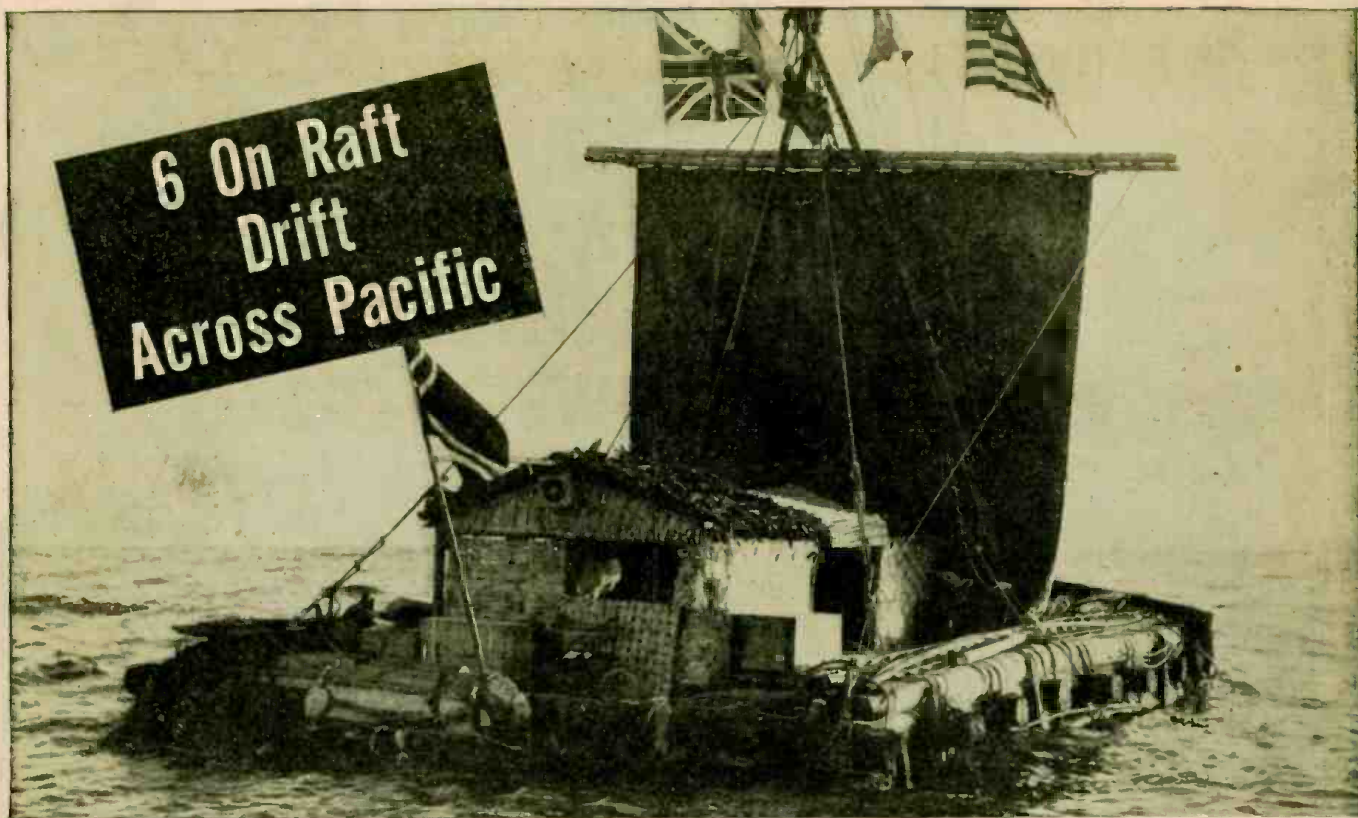

Courtesy of Science Illustrated

KON-TIKI EXPEDITION PICKS NATIONAL RECEIVERS

Somewhere in the vast loneliness of the Pacific a frail, balsa wood raft is drifting westward, carrying six Norwegian scientists toward the Polynesian Islands. Their mission: to prove that the Polynesians could have been settled by prehistoric Peruvian Indians.

Courage, yes, recklessness, no. These adventurers are scientists, not stunt men. Before setting out from Peru they made sure that they would have the finest radio equipment in the world . . . National receivers, of course (Models NC-173 and HRO-7).

For safety . . . to bring in the weakest signal in the worst kind of weather . . . for science . . . to exchange vital weather and navigational data with land stations thousands of miles away. Battered by wind and sea for months on end these superb National receivers aboard the Kon-Tiki Expedition raft are still functioning as reliably as ever.

What better testimonial than operator Knut Haugland's cheerful "All's Well" radioed from the Tuamotu Archipelago . . . 4000 miles across the Pacific, and still going strong.

Congratulations are also in order to W6AOA, W6EVM, and W3YA who have been in regular contact with LI2B. 27.98 and 14.142 megs have been assigned for general contact. Next time you go on the air, why not see if you can contact Haugland and get the Expedition's story first-hand.

National
Company, Inc.
 Malden, Mass.

MAKERS OF LIFETIME RADIO EQUIPMENT



National Receivers of the Type Selected for the Kon-Tiki Expedition



HRO-7

Brand-new successor to the famous HRO used throughout the world. 11 tubes plus a voltage regulator. . . . Frequency coverage from 50 to 430 and 480 to 30,000 kc. . . . Adjustable Threshold Noise Limiter. Streamlined grey cabinet. AM phone and code reception.



NC-173

A new and versatile receiver, popularly priced. Frequency coverage from 540 kc to 31 mc plus the 48-56 mc range. Calibrated amateur band spread on 6, 10-11, 20, 40 and 80 meter bands. Phonograph or Microphone pick-up jack.

2 METHODS

Learn RADIO-ELECTRONICS

at HOME... or in our LABORATORIES

TAKE YOUR CHOICE!



LEARN IN CHICAGO IN ONE OF NATION'S FINEST TRAINING LABORATORIES

36 weeks — that's all the time you need to get one of today's finest practical trainings in RADIO and ELECTRONICS. That's all the time required to prepare yourself for America's great opportunity field that offers so many thrilling possibilities for a GOOD JOB with a REAL FUTURE — or a profitable RADIO SERVICE BUSINESS OF YOUR OWN.



MODERN TELEVISION TRAINING calls for ample equipment. In our modern Chicago training laboratories, you will find some of the finest Television equipment available for training purposes.

Now you can enjoy outstanding training advantages in the large, entirely NEW postwar laboratories of DeForest's Training, Inc. in Chicago. You get ALL of your instruction amid a large staff of highly skilled instructors and loads of modern, costly commercial Radio-Electronic and Television equipment.

We secure comfortable living quarters for you. Get complete facts about this remarkably effective way to qualify yourself QUICKLY for a GOOD PAYING FUTURE — and about our EMPLOYMENT SERVICE that helps our graduates GET STARTED. MAIL COUPON BELOW FOR COMPLETE DETAILS.

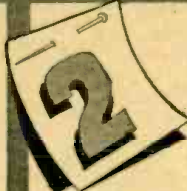

GET "SHOP METHOD" TRAINING AT HOME — IN YOUR SPARE TIME

Look around you! What other field embraces so many exciting, fast-moving activities as F. M. Radio, 2-Way Train Radio, Aviation Radio, Broadcast Radio, Radio Manufacturing, 2-Way Bus, Truck and Cab Radio, Police Radio and other branches?

DeForest's Training, Inc. makes it possible for YOU to train in the privacy of your own home for this bright field of Radio and Electronics — and without interfering with your present job.

You get a long-tested, PROVED combination of home study advantages — plus EMPLOYMENT SERVICE — which helps you get started toward a real future in Radio and Electronics.

3-Way Method Gets Results!

No previous RADIO or ELECTRONIC experience is necessary. Our effective A-B-C Home Study Method includes (A) "Learn-By-Doing" Home Laboratory of many Radio parts enabling you to work out 133 fascinating experiments at home, including 7 different Radio Receiving Circuits; (B) a 16 mm. Movie Projector and 12 reels of "Learn-By-Seeing" Movie Film that speed your progress; and (C) well-illustrated lessons. MAIL COUPON BELOW FOR COMPLETE DETAILS.

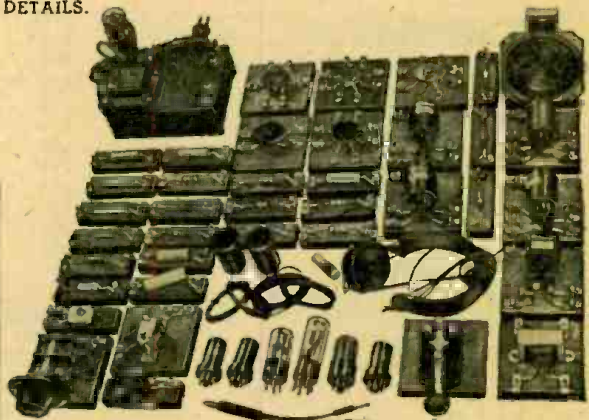

ABOVE: You work out 133 intriguing experiments from this equipment to get valuable, practical experience AT HOME.

VETERANS!

Both our (1) Chicago Laboratory and (2) Home Study Courses are accepted under the "G. I. Law." If you qualify, the Government will pay cost of either Course you select.

DEFOREST'S

TRAINING, INC.

Affiliated with the DeVRY CORPORATION
CHICAGO, ILL.

E. B. DeVry, President
DeForest's Training, Inc.
2533 N. Ashland Ave., Dept. RC-D9
Chicago 14, Ill.

Please send me information about the Radio-Electronic Course I have checked:

HOME STUDY CHICAGO LABORATORY BOTH

Name Age

Address Apt.

City Zone State

If under 16, check here for special information.

If a discharged Veteran of World War II, check here.

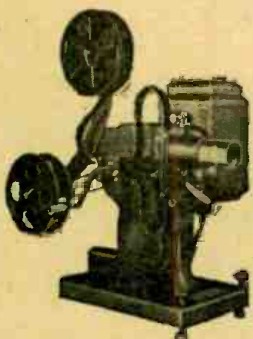

D.T.I.'s Home Study Course Includes the use of a 16 mm. Motion Picture projector and Movie film to help you learn important fundamentals FAST-ER... EASIER. Get vivid — LASTING impressions by means of the modern MOVIE-WAY method of instruction.

CRYSTALS

**SUN RADIO
COMPLETES
WORLD'S LARGEST
PURCHASE OF
CRYSTALS**



CRYSTAL FREQUENCY STANDARDS

98.356 KC

Easily altered for 100 kc Standard.
Mounted in low
loss 3 prong
holder. **4.49**

In the greatest purchase of radio transmitting crystals ever made by one wholesaler in the history of the Radio Parts Industry Sun Radio acquired title to over a half million dollars (\$500,000.00) of Army Surplus precision built, exactly tooled crystals in moisture proof holders. Can you visualize the immensity of this stock of ours . . . thousands, or should we say miles, of gleaming BRAND NEW CRYSTALS IN MOISTURE PROOF HOLDERS manufactured by the world's finest crystal manufacturers (RCA, Bliley, Western Electric, etc.) lying long rows; lovely to look at but even better to

own. We can't claim we can supply every frequency but we do claim that we can supply you with brand new crystals of the below listed frequencies AT THE LOWEST PRICES YOU HAVE EVER SEEN. You can now afford to standardize your transmission and you can now afford to vary your frequencies . . . We say It's Sensational!!!! And remember, you may never again see the day that you can buy BRAND NEW CRYSTALS IN MOISTURE PROOF HOLDERS at the prices that we have offered here . . . As always, "IT'S SUN RADIO THAT COMES UP WITH THE BEST IN VALUES."

400 Kc AUDIO STANDARD **1.95**

BLILEY 186.30 kc
IN TYPE MC 72
HOLDER **59c**

CRYSTALS WITH A MILLION USES

Fractions Omitted

412kc	429kc	445kc	469kc	490kc	505kc
413	430	446	470	491	506
414	431	447	472	492	507
415	433	448	473	493	508
416	434	451	474	494	509
418	435	453	475	495	511
419	436	456	477	496	512
420	437	457	479	497	515
422	438	458	481	498	516
423	440	459	483	501	518
424	441	462	484	502	519
425	442	463	485	503	522
426	443	466	487	504	523
427	444	468	488		

49c
EACH

I. F. FREQUENCY STANDARDS

450kc	455.556kc
451.388kc	459.259kc
452.777kc	461.111kc
454.166kc	464.815kc
	465.277kc

99c
EACH

FOR CRYSTAL CONTROLLED SIGNAL GENERATORS

525kc	
526.388	533.333
527.777	534.722
529.166	536.111
530.555	537.500
531.944	538.888

99c

FOR HAM & GENERAL USE

Fractions Omitted

390kc	397kc	406kc
391	398	407
392	401	408
393	402	409
394	403	411
395	404	
396	405	

79c

ASSORTED MISCELLANEOUS CRYSTALS

Fractions Omitted

370kc	377kc	384kc
372	379	386
374	380	387
375	381	388
376	383	

39c

*priced at a fraction of
the cost of their
holders alone.*

- ★ Payment with order
- ★ Enclose 20c for postage and handling
- ★ Minimum order—\$2.00 plus postage
- ★ Please specify alternate choices or "no substitutes"

SUN RADIO
OF WASHINGTON, D. C.
938 F STREET, N. W. WASH. 4, D. C.

MAKE MORE MONEY

Radio TELEVISION & ELECTRONICS

GET THESE 2 BIG BOOKS

Now!
FREE!

You men already in Radio know how great the demand is for trained, experienced servicemen, operators and technicians. You know how fast the field is growing and how important it is to keep up with developments—F.M. Receivers, Electronics and Television. You know, too, a fellow cannot learn too much about any industry for **REAL SUCCESS**. Whether you have experience or are merely **INTERESTED** in radio as an amateur, you must recognize the **WONDERFUL OPPORTUNITY** right within your grasp to cash in on your natural abilities. Make them pay dividends. Get into the **EXPERT RADIO SERVICE FIELD**. Be an F.M. and **TELEVISION specialist—OWN A BUSINESS OF YOUR OWN**, if you prefer. Fill out and mail the coupon below for all the details of our plan.

Get the Latest Inside Information—Short Cuts—Trade Secrets by

Here's Just a Few of the Interesting Facts you Learn with the **FREE MANUAL**.

1. Routine for diagnosing Radio Troubles.
2. Preliminary Inspection of Receivers.
3. How to Check Power Supply.
4. How to Identify Various Stages of Receiver.
5. How to Trace the Circuit and Prepare Skeleton Diagram.
6. How to Test and Measure Voltages.
7. How to Test Speaker in Audio Stages.
8. How to Test Detector, I.F., R.F., and Mixer Stages.
9. Complete Reference Table for Quickly Locating Receiver Troubles.

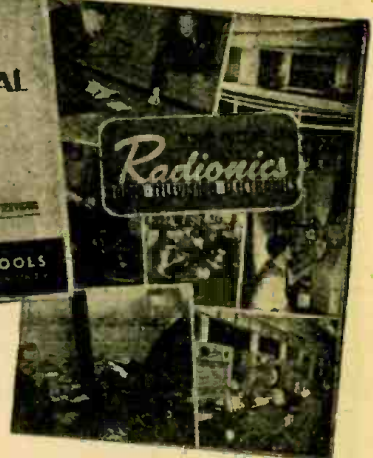
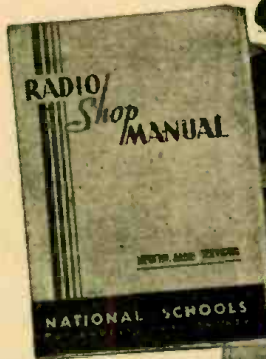

SHOP METHOD HOME TRAINING

FROM A REAL ESTABLISHED RESIDENT SCHOOL

Now the famous National Schools brings its exclusive Shop-Method of training right into your own home. You can learn the most up-to-date, approved projects, systems and circuits step by step in your spare time. This is the sound and practical training you want and need—the development of experienced instructors working with thousands of students right in shops, NEW F.M. broadcast studios and experimental laboratories of **NATIONAL SCHOOLS**—one of the most advanced trade educational centers in the world.



LEARN BY DOING

Work with Real Experimental Equipment Furnished without Extra Cost as Part of Your National Training

Experience is the best teacher. You learn by experience with the exclusive National Shop-Method of Home Training. In the course of your study you actually build various types of receivers—a powerful superheterodyne, a signal generator, an audio oscillator and others—You make tests and conduct experiments that show you the why and how of things. You understand what makes the various elements of electronics operate because you actually see them work for you. Not only do you gain marvelous experience by this method of learning but you receive valuable equipment you will use on the job in the practice of your profession as an electronics expert. Mail the coupon and learn what this means to you.

Send the Coupon and prove to yourself what YOU can do in RADIO!

VETERANS

If you qualify for training under G. I. Bill, check the coupon for a Special Bulletin.

Be Sure Of Your Success And Security

Don't let your post-war ambitions lag. Don't let YOUR future depend on others. Build a career for yourself. Never in all history have there been such great futures in Radio, Television and Electronics. Here is a new world opening before you. You can prepare to step into an essential, well paid position or, if you wish, GET INTO BUSINESS FOR YOURSELF. Start NOW. Radio men are vitally needed. Fill out and mail the coupon immediately and examine the **NATIONAL SHOP TRAINING METHOD COURSE** carefully, without obligation.

NATIONAL SCHOOLS

LOS ANGELES 37, CALIFORNIA EST. 1905



MAIL OPPORTUNITY COUPON FOR QUICK ACTION

National Schools, Dept. 9-RC
4000 South Figueroa Street, Los Angeles 37, California.

(Mail in envelope or paste on penny post card)

Mail me **FREE** the two books mentioned in your ad, including a sample lesson of your course. I understand no salesman will call on me.

NAME AGE

ADDRESS

CITY ZONE STATE

Check here if Veteran of World War II.

FREE LESSON INCLUDED

Examine the exclusive National Shop Method of Home Training. See for yourself how sound and practical it is. Be convinced that you can learn Radio, Electronics, Television—quickly and easily, in your spare time. You can't tell until you try. This trial is **ABSOLUTELY FREE**. Fill out the coupon immediately while you are thinking about it and drop it in the mail at once.

Mail the coupon here for the books that tell you the complete story of the marvelous new system of training in Radio, Electronics and Television. Learn the facts of this exclusive shop-method of home training. See for yourself! **DECIDE FOR YOURSELF!**

This is the **MODERN SYSTEM OF TRAINING**: it matches the rapid progress constantly being made in Radio, Television and Electronics. It is **TIME TESTED**, too. National Schools has been training men for more than a third of a century. It is the very same training that has helped thousands to more pay and greater opportunity.

You owe it to yourself—your future—to read the book "Your Future in Radio, Electronics and Television"—**FREE** to you when you send in the coupon.

SEPTEMBER • 1947

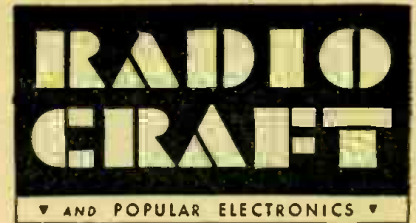

Incorporating
SHORT WAVE CRAFT TELEVISION NEWS
RADIO & TELEVISION

Editorial: Printed Radios	by Hugo Gernsback	17
Radio-Electronics Monthly Review		18
Radio Thirty-Five Years Ago		63
Radio Inventions Wanted		67

Electronics

Robot Makes Radios	by Major Ralph W. Hallows	20
Electronic Egg Grader (Cover Feature)	by S. R. Winters	22

Amateur Radio

BC-624 on Two Meters	by L. W. May, Jr., W5AJG	24
Mobile Xmitter for Two Meters	by Ernest L. Byrd	26
250-Watt FM-AM Transmitter	by Harry D. Hooton, W3KPX	30
Part III—How the FM circuits are aligned		

Servicing

Static Hunting is Profitable!	by Paul W. (Slim) Streeter	28
Low-Priced FM Tuning Unit		27
English Repair Methods	by Eugene A. Conklin	56
A Freak Repair Problem		78

Sound

Response Equalization	by John W. Straede	34
Postwar Features of Phonograph Pickups	by I. Queen	36

Test Instruments

Audio Oscillator with Band Spread	by C. F. van L. Weiland	32
Part II—Constructing the Oscillator		
Signal Tracer-Injector for Efficient Servicing	by Lyle C. Treakle	31

Construction

Lightweight Portable Photoflash	by W. G. Many	23
---------------------------------------	---------------	----

Departments

Transatlantic News	by Major Ralph W. Hallows	38
New Radio-Electronic Devices		40
Radio-Electronic Circuits		42
Try This One		44
The Question Box		46
World-Wide Station List	Edited by Elmer R. Fuller	50
New Radio-Electronic Patents	Conducted by I. Queen	54
Technotes		76
Communications		80
Book Reviews		83

HUGO GERNSBACK
Editor-in-Chief

FRED SHUNAMAN, *Managing Editor*

M. HARVEY GERNSBACK,
Consulting Editor

ROBERT F. SCOTT, W2PWG,
Technical Editor

ANGIE PASCALE, *Make-up Editor*

I. QUEEN, W2OUX, *Editorial Associate*

ELMER FULLER, *Shortwave Editor*

G. ALIQUO, *Circulation Manager*

JOHN J. LAMSON,
Advertising Director

ALFRED STERN, *Promotion Manager*

In an Early Issue:

PLASTIC CABINET REPAIRS
CARRIER-CURRENT XMITTER
SELLING HOME RECEIVERS

On THE COVER:



An electronic egg grader which is in actual use at Cornell University is our cover picture this month

*Chromatone by Alex Schömburg
from photograph by John F. Brock*



RADCRAFT PUBLICATIONS, INC. Hugo Gernsback, President; M. Harvey Gernsback, Vice President; G. Aliquo, Secretary

Contents Copyright, 1947, by Radcraft Publications, Inc. Text and illustrations must not be reproduced without permission of Copyright Owners.

RADCRAFT PUBLICATIONS, INC. • PUBLICATION OFFICE 29 Worthington Street, Springfield 3, Mass. • EDITORIAL AND ADVERTISING OFFICES 25 West Broadway, New York 7, N. Y. Telephone REctor 2-9690.

BRANCH ADVERTISING OFFICES: Chicago: 308 W. Washington Street, Suite 1413, Chicago 6, Ill. Tel. Randolph 7363. Cleveland: Burdette Phillips, Manager, 405 Erie Bldg., Cleveland, Ohio. Tel. Main 9645. Detroit: Frank Holstein, Manager, 307-8 Boulevard Bldg., Detroit, Mich. Los Angeles: Ralph W. Harker, Manager, 606 South Hill St., Los Angeles 14, Calif. Tel. Tucker 1793. San Francisco: Ralph W. Harker, Manager, 582 Market St., San Francisco 4, Calif. Tel. Gerfield 2481.

RADIO-CRAFT, September, 1947, Volume XVIII, No. 12. Published Monthly on 28th of month preceding date of Issue. Allow one month for change of address. When ordering a change, please furnish an address stencil impression from a recent wrapper. All communications about subscriptions should be addressed to the Circulation Manager, Radio-Craft, 25 West Broadway, New York 7, N. Y.

SUBSCRIPTION RATES: United States and possessions, Mexico, Central and South American countries, \$3.00 a year; 5.00 for two years; \$7.00 for three years. Canada, \$3.50 a year; \$6.00 for two years; \$8.50 for three years. All other foreign countries, \$3.75 a year; \$6.50 for two years; \$9.25 for three years. Entered at Post Office, Springfield, Mass., as sec. class matter under the Act of March 3, 1879.

FOREIGN AGENTS: Great Britain: Atlas Publishing and Distributing Co., Ltd., 18 Bride Lane, Fleet St., London E.C.4. Australia: McGill's Agency, 179 Elizabeth Street, Melbourne. France: Brentano's, 37 Avenue de l'Opera, Paris 2e. Holland: Technisch Bureau Van Baerle, Bemelmans & Co., Heemsteedsche, Dreef 124, Heemstede. Greece: International Book & News Agency, 17 Amerikis Street, Athens. So. Africa: Central News Agency, Ltd., Cor. Rissik & Commissioner Sts. Johannesburg; 112 Long Street, Capetown; 369 Smith Street, Durban, Natal. Universal Book Agency, 70 Harrison Street, Johannesburg. Middle East: Steimatzy Middle East Agency, Jaffa Road, Jerusalem. India: Magazines Distributors, 5 Bombay Mutual Annexe, Gunbow Street, Fort, Bombay 1.

TELEVISION-

**America's Next
Giant Industry?**



Billboard Announcing Telecasts of
Ball Games in Chicago



U. A. Sanabria

Dr. Lee deForest

The Men Who Direct American Television

The instructional quality of training is under the constant personal supervision of two internationally known engineers, Mr. U. A. Sanabria, President and Founder of American Television, Inc. and Dr. Lee deForest, the famed inventor of the radio tube.

Today, **RIGHT NOW**, clear and bright pictures of great sports events, as well as other equally interesting programs, are being telecast for the enjoyment of thousands. Television stations in New York, Chicago, Philadelphia, Washington, Detroit, St. Louis and Los Angeles are already operating on regular schedules. Construction has started in several other centers and it is believed that practically every major city in the country will have this wonderful service before the end of 1948.

Who will build, maintain, and operate the new telecast stations? Who will design, produce, install and service the receivers?

Men Must Be Trained for These New Professions

Alert young men with an ambition to grow with television are training now in the greatly enlarged instruction laboratories of American Television, Inc. A wide choice of courses available. Advanced methods and latest obtainable equipment used.



FREE PRE-ENTRANCE COURSE

A Short Home Study Television Course is available to qualified war veterans who are considering residence training. This course is free of any charge or obligation. Your success with it will help you to learn your own abilities in television. It will also aid us greatly in qualifying you for residence training. Your acceptance of the Home Study course in no way obligates you to enter our residence school. So we urge you to take advantage at once of the very unusual opportunity it offers.



Approved for Veteran Training Under G. I. Bill of Rights

American Television, Inc.

5050 BROADWAY

CHICAGO 40, ILLINOIS

REQUEST FOR FREE INFORMATION

American Television, Inc., Dept. of Information
5050 Broadway, Chicago 40, Illinois

Please send details of your Television Training.

NAME _____

ADDRESS _____

CITY _____ ZONE _____ STATE _____

I am a veteran

One of Our New Buildings.
Air Conditioned the Year Round.





SCR-610 low power FM transceiver. Battery operation on 27mc to 38.9 mc. Less crystals\$39.50

Magnets. Powerful, Permanent, Alnico magnet. Consists of two curved and covered pole pieces with .645" gap. Develops 4850 gaussels invaluable for High frequency or magnetism work \$8.00

Signal Generator-WE. Regulated power supply 115VAC 60cy. 2700-3000 mc. Contains output meter \$50.00

The Highest Values "Communications" at the Lowest Cost

TUNING UNITS

Ideal Basis for E.C.O. Rig

Tuning units for TCE & GP7 in the following frequencies: A-850 to 800 kcs; B-800 to 1500 kcs; C-1500 to 3000 kcs; E-4525 to 6500 kcs; F-6200 to 9050 kcs. Contains all coils, etc. for these frequencies. Complete set of five \$11.00

Units C. F. Each 2.75
Units A. B. E. Each 2.00

From BC191 and 375—contains: coils, chokes, dials, condensers. Range of frequency from 400 KC to 12.5MC. State your approximate frequency. Only \$2.75



SPECIALS

RG-9U Coax, GE, silver coated copper. 51 ohm surge impedance. Sold in 100 ft. lengths and 500 ft. reels. Per ft. \$0.07 1/2

Rectifier transformer—117VAC input; output 62V at 3.5A. AC. Rectify and use with filter and rheostat to run your 6, 12, and 24VDC equipment. 1.50

Capacitor—continuous phase shift; effective range 100 cy to 800 kc. 1.95

Vibrator Transformer—Primary: 6, 12 and 24V; secondaries: (2) 120V @ 175ma. (1) 11V. Dimensions: 3.25"x3"x1.3" 1.00

Selsyns—Type 5G 115V. 60C AC Dim: 3 3/4"x5 1/4". Special: a pair 7.75

Toggle sw—4PDT. bat handle69

Power Pair—Transformer 470V CT @ 30ma; two 6.8V windings @ 1.65A and two 5V @ 2A—Primary: 115V 50 to 1200 Cy. PLUS a 6 Hy. 50 ma choke. Both 1.98

Feed Thru Insulator—3" cupped shaped pair with flexible whip ant. mts. Can be used either for feed thru or as whip ant mast base 1.50

Antenna Grounding Switch—A MUST FOR EVERY SHACK. Rated 100 amps 2500 volts Silver ball contacts 1.98

Radio Noise Filter—by Sprague. Type JX49. 250VA89

Ceramic Coil Forms. 5 assorted 1.00

Terminal Strips. 8 assorted 1.00

Single Contact Connectors — Chassis mounting female receptacle. Similar to Amp. 83-1R .45

Feed-thru type female receptacle. Similar to Amp. 83-1F45

RC-145 & 148

1KW pulse output on 154 to 186mc. 117 VAC power supply. Can be converted to CW- or Voice operation without difficulty and easily lowered to 144-148mc band. 5 stagger tuned receiver IF stages make for ready adaptability to FM or TV. Can be used as a low power Radar set.

RC-145, NEW, complete with instruction book, including Selsyn rotary-beam direction indicator unit \$200.00

RC-148, consists only of transmitter and power supply. Both units with tubes. Slightly used \$47.50



MICROWAVE TUBES

MAGNETRONS	
3331 (1cm)	\$17.50
3331 magnet	8.00
2126 (10cm)	25.00
2132 (10cm)	25.00
2138 (10cm) with max. net	37.50
WE 700A (L Band)	35.00
WE 720BY (S band)	20.00
QK59, QK60, QK61, QK62 tunable packaged magnetrons. 10 cm	45.00
CLYSTRONS	
2K25/723ab	7.75
2C40 Lighthouse tube	2.50

Antenna AT-4/ARN-1 Half wave dipole at 440 mc. Mounted on two vertical supports with coax connector at base \$2.00

Antenna 104, quarter wave VHF antenna radiating surface 21 1/2" long. Has 72 ohm coax receptacle at base \$2.00



Remote Control Unit RM-29 — ideal for telephone inter-communication over distances up to several miles. Includes ringer. 2 units complete with handsets for two way communication \$14.00
RM-29, each 5.50
Handset, each 2.00

TRANSFORMERS

All Primaries 117V 60cy Secondaries
No. 5084—1000V CT and 880V CT @ 250 ma. 6.3V @ 1.5A \$6.95
No. 5114—1500 V CT @ 200ma and 5V @ 3A 6.95
No. 5190—6180V @ 200 ma 14.75
No. 5057—6.3 CT 1A, 5V CT 2A, 5V CT 3A 2.75
No. 5104—6.3V @ 1A, 6.3V @ 1A, 6.3V @ 1A 2.45
No. 5126—5V CT 3A, 5V CT 3A, 5V CT 6A 3.25

CHOKES
Amertran—RMS test 15KV. 1 Hr. .8 amp DC. DC resistance 7.5 ohms \$8.95
8.5 Hy. 125ma. 1780V Test 1.45
Dual: 7 Hy. 75 ma. 11 Hy. 60 ma. 1780 V test 1.95
Dual: 2Hy. 100ma each section. Utah80
Filter choke, 5HY 40ma45

AUDIO TRANSFORMERS
No. 6261 — SB mike to grid transf. (20:1) \$1.00
No. 5651 — Modulation transf. 807 to pair of 807's 1.00

PULSE TRANSFORMERS

All Standard name items
Type K2450A will receive 13KV. 4 microsecond pulse on pri. secondary delivers 14 KV Peak power out 100KW \$15.00
HI Volt. Magnetron Input transformer # D-16617s with cooling fins 12.00
UXH 429BE—Pri. 4.5V 1 microsecond sec. 16 KV. 16 Amps. Fil. pri. 115V 400 Cycle 15.00
Hi Volt input pulse Transformer # D169271 9.95
Radar pulse former K2731 Diameter App. 11" vertical cooling fins 19.50
Pulse Input line to magnetron 2.49
K2748A 12.00

SONAR SOUND DETECTION UNIT

Ideal for detecting underwater sounds, such as fish swimming in schools, within a 15 mile area. Using a Rochelle salt crystal, which is about 1000 times more sensitive than quartz. It is completely enclosed in a solid rubber sheath. This sound detector was originally used in harbor defense. Coupled to an audio amplifier, this can be found to have many valuable applications. It's the Model 11k which contains 7 microphone units for three times as much sensitivity as the SD-1 \$12.50

DYNAMOTORS

For that emergency rig

DM-21: In 14VDC 3.3A Out 235VDC 98 ma with filter	\$2.59
DM-25: In 12VDC 2.8A Out 250VDC 50ma	2.49
DM-34: In 14VDC 2.8A Out 220VDC 80ma	2.49
DM-42: In 14VDC. Out 515/1030 VDC 215/260ma & 2/8VDC	3.95

HAND GENERATORS

GN-45 Plate & fil supply. Output 500VDC 140 ma and 6V 3A. Dim. 8"x8"x6" \$4.95
GN-36 2.5 amp at 8V. 100 ma at 325 to 365V; or 1.25 amp at 10V. 70 at 380 to 420V 3.50

TRANSMITTING TUBES

837	\$1.50	705A	\$3.95
872A	2.98	304TL	3.95

705A sockets, each65

CATHODE RAY TUBES

3BP1	\$3.95	5FP7	\$3.00
3CP7	2.00	5JP2	8.95
5CP1	4.95	5BP4	4.50

Dibenthal CR socket 2 1/2" dia.59

OIL CONDENSERS



Aerovox,

C-D, Sprague

.25 MF—20,000 V. \$17.50

Sprague, Aerovox, Cornell-Dubilier

15 mf 220 VAC.	1.5	5 mf 2000 vdc	\$1.25
600vdc CD	\$1.75	10 mf 600 vdc	.85
1mf 300 vdc	.25	5-2.5-2.5 mf 600 vdc	.75
4 mf 300 vdc	.25	7 mf 800 vdc	.90
4 mf 400 vdc	.30	3.5-5 mf 1000 vdc	1.00
5.5 mf 400 vdc	.50	1 mf 1000 vdc	.75
1 mf 500 vdc GE	.25	2 mf 1000 vdc	.25
2 mf 550 vdc	.25	4 mf 1000 vdc	1.00
.25 mf 600 vdc	.20	4-1.5 mf 1000 vdc	1.00
.85 mf 600 vdc	.25	10 mf 1000 vdc	1.40
1 mf 600 vdc	.30	1 mf 1500 vdc	.95
1.1 mf 700 vdc G.E.	.4	4 mf 1500 vdc	.15
2 mf 800 ac/1000 vdc	1.50	2 mf 2000 vdc	.85
2 mf 600 vdc	.35	1-1 mf 2000 vdc	1.00
10 lofts of 50	1.50	1-1 mf 2000 vdc	1.00
5-8 mf 600 vdc Tobe	1.00	1 mf 3000 vdc	4.95
8-3-4 mf 850 vdc GP	1.45	1 mf 7000 vdc	12.50
6 sect. ceramic stack variable 35-460 mmmf	1.79	3.5 mf 20,000 vdc	17.50
2 mf 1000 vdc Sprague	.50	1.5 mf 8000 vdc	12.50
10-10-10 mf 90 vac	1.95	4 mf Solar, 30 WVDC	1.49
2 mf 600 vdc	.40	500 mf 250 v CD	2.00
		4000 mfd 30 v CD	2.50

MICAS
.002 mf 15000 v San-gamo 20.00
.002 mf 8000 v 8.50
.005 mf 15000 v 22.00
.006 mf 10000 v 17.50



RCA 12 Tube Superhet
100 to 1500KC. 115V operation Dim: 24"x18"x13". Used: in excellent condition guaranteed .. \$29.95

B-29 Computer Amplifier. Contains 8 relays, 8 6SN7 tubes, 5 neons, 1 6x5. Completely wired with all components. New, only ... \$9.95

ARC-5 Receiver Accessories

Triple head control box	\$1.00
Plug-in coil unit 10-52 mc or 52-1.5 mc ea	.50
Mounting rack	1.00
Double mounting rack	1.65
Shock mounts	.95

All parts interchangeable with SCR-274-N.

Headgear Dynamic mike and headset combination, sound powered. From B-19. Mikro and ear-phones complete. \$2.75

HEADSETS
New insert type — comfortable & lightweight, efficient. 500 ohms impedance \$5.85
Output transf. to match 500-8000 ohms imp. \$2.25 extra

Relays — Miniatures

SPDT 24VDC	\$4.40
SPST 28VDC	.40
DPDT 28VDC	.45
SPST 100V overload 380/1800cy	.40
SPDT 110VAC 380/1800cy	.40

Discount on Lots
Telephone Relays
SPDT—with cover .. 1.05
DPST 1.05

Miscellaneous Types

SPDT 5VDC in case with 5 pr. base	.85
DPDT 6VAC Struthers-Dunn	1.45
DPST 6VAC Struthers-Dunn	1.35
2 Section SPDT 6 VAC Wheelock type	1.10
SPDT 115 VAC Leach	1.00
SPDT 115 VAC, WE Wheelock type	1.25
SPDT 115 VAC, Kurman latch type	2.49
SPDT 115VAC GE, with SPST thermal delay section	1.95
DPST 24VDC Allied	.75
DPST Leach antenna relay with SPST revr section 24 VDC & 12VDC	1.25
SPDT 24VDC GM	.85
4PDT contactor 24VDC Leach	1.05
Thermal delay, 45 to 60 sec. Edison type 1508 with 4 prong base	2.95
6VDC Relay Panel	
3-DPST; 2-SPST 6 vdc relays mtd on 10"x7" panel	2.75



COMMUNICATIONS EQUIPMENT CO.

131-C LIBERTY ST., NEW YORK 7, N.Y. TELEPHONE WH 4-7658

Six Months from Today Which will YOU hold?

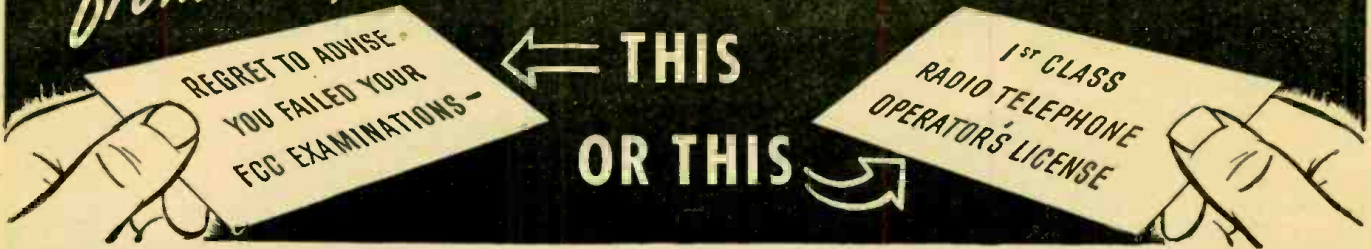

WANT YOUR FCC COMMERCIAL LICENSE IN A HURRY?

Use CIRE Training and Coaching Service—and Get Your "Ticket" in a Few Short Weeks!

Thousands of new jobs are opening up—FM, Television, Mobile Communication Systems—These are only a few of the radio fields which require licensed radio technicians and operators.

Get your license without delay—Let Cleveland Institute prepare you to pass FCC license examinations, and hold the jobs which a license entitles you to, with CIRE streamlined, post-war methods of coaching and training.

Your FCC Ticket Is Recognized in ALL Radio Fields as Proof of Your Technical Ability.

More than ever before an FCC Commercial Operator License is a sure passport to many of the better paying jobs in this New World of Electronics.

Employers frequently give preference to the license holder, even though a license is not required for the job. Hold an FCC "ticket" and the job is yours!

HUNDREDS OF SATISFIED, SUCCESSFUL STUDENTS

"I have taken the first class phone license examination and received my first class ticket last Saturday May 31. In closing I must say yours is an excellent radio course, and I really appreciate your help and the fine service you have rendered me."
Student #2876N12

"I passed the FCC examination in radiotelephone 2nd class, at Detroit on June 3rd, and I want to thank you for your ready assistance as my instructor on Section I of Nilson's Master Course."
Student #2779N12

"I have had my 1st class radiotelephone license since March of this year, and plan to continue with your course since I find it a great help in studying transmitters."
Student #2779N12

"After sending in Lesson E I took the commercial operator's license examination for 2nd class radiotelephone, and passed O.K. I received the license last week."
Student #2772N1

FREE BOOKLET—Tells you the Government requirements for all classes of FCC COMMERCIAL licenses. (Does not cover Amateur License examinations). Use coupon below for Booklet B.

OTHER CLEVELAND INSTITUTE HOME STUDY COURSES OFFER COMPLETE TECHNICAL RADIO TRAINING FROM LOW-LEVEL TO COLLEGE-LEVEL, FOR THE RADIOMAN WITH PRACTICAL EXPERIENCE!

COURSE A—MASTER COURSE IN RADIO COMMUNICATION

A complete course covering the technical fundamentals of radio-electronics, for the radioman who wants a general review. Includes preparation for Broadcast station employment.

COURSE B—ADVANCED COURSE IN RADIO COMMUNICATION ENGINEERING

A genuine college-level radio engineering course, completely mathematical in treatment. For the advanced radioman with considerable practical experience and training.

COURSE C—SPECIALIZED TELEVISION ENGINEERING

An advanced college-level course for the radioman who has had foreman training equivalent to A and B.

These three courses in radio-electronics offer a complete, thorough technical training for a radioman who wants to cover the field. Available separately or combined.

FREE CATALOG—Describe all Cleveland Institute home study courses—tells of CIRE unique, post-war methods of training. Use coupon below for Catalog A.

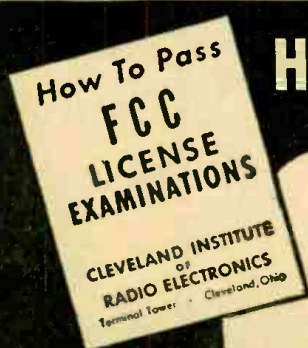

HOW TO PASS Commercial Radio Operators' FCC LICENSE EXAMINATIONS...

CLEVELAND INSTITUTE OF RADIO ELECTRONICS

Contractors to the Canadian Broadcasting Corporation

RC-9 TERMINAL TOWER

CLEVELAND 13, OHIO

CLEVELAND INSTITUTE OF RADIO ELECTRONICS
RC-9 TERMINAL TOWER, CLEVELAND 13, OHIO

Veterans check for enrollment information under G-1 Bill. NO OBLIGATION—NO SALESMEN.

Gentlemen: Please send me your Booklet B, "HOW TO PASS THE FCC COMMERCIAL LICENSE EXAMINATIONS," and information about your home study course for preparation for FCC License Examination. (Does not cover Amateur license examinations.)
 Please send me your Catalog A, describing all of your home study radio-electronics courses. I desire training in course A B C.

NAME
ADDRESS
CITY ZONE STATE

Don't Delay—Write Today!

Approved for Training under "G-1 Bill of Rights"



ESSE Specials!

UNLESS OTHERWISE SPECIFIED, MERCHANDISE HAS BEEN REMOVED FROM SURPLUS AIRCRAFT AND IS SOLD AS USED.

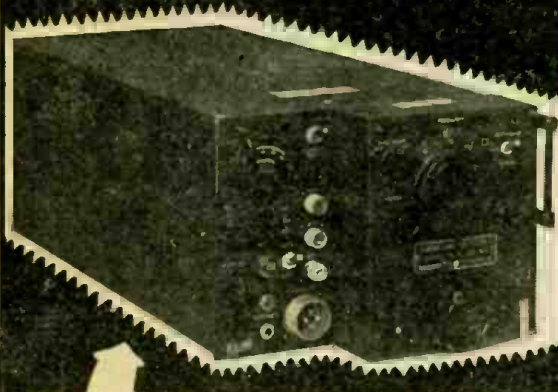

RECEIVER AND TRANSMITTER RT-34/APS-13.
 Ideal for conversion for amateur mobile use on VHF frequencies. These units are very clean and come complete with dynamotor for 28 V DC input, 285 V. 60 Ma. output, 9-6AG5, 5-6J6, 2-2D21 and 1-VR-105 tubes, co-axial connectors, potentiometers, relay, etc.
 PRICE.....\$11.75

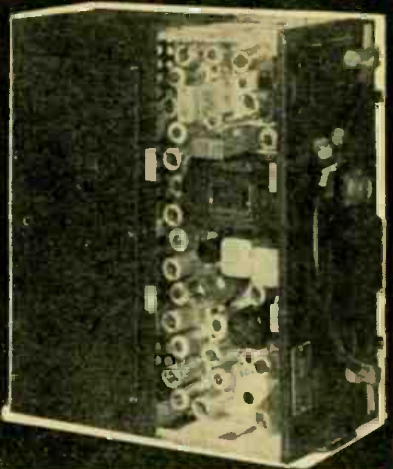

R-54/APR-4 RECEIVER.
 Complete with Tuning Unit TN-17/APR-4 for 74-320 Mc. band. Operates from 115 V 60 cycle AC source.....\$75.00
 Extra Tuning Unit TN-18/APR-4 for 320-1,000 Mc. band....\$17.50

ARR-1 RECEIVER—34-58 Mc.
 Ideal for mobile receiver or converter on 2 or 6 meter band
 Contains 4-954 type acorn tubes, connectors, etc.
 PRICE \$7.95

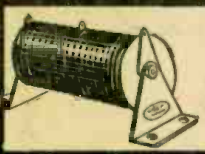

BL-SELENIUM RECTIFIER TYPE 23751
 A must for the radio man for the much needed 110 V. DC source. 110-120 V. AC input, 110-135 V. DC output at .75 amp. Connect in parallel for higher current requirements. Size 3 1/2x2 3/4x1 1/4 inches.
 PRICE—New.....\$1.65 ea.



BC-966-A IFF.
 Contains following: Pioneer Gen-E-Motor, 18 V. input, 450 V. 60 Ma. output; 65W 40 ohm resistor; 1 Mfd. 1000 V. condenser; 4-lo-current relays; 4-7193, 7-6SH7, 3-6H6; Eclipse Carbon pile type voltage regulator, etc.
 PRICE.....\$8.75

COLLINS ART-13 TRANSMITTER
 Complete with dynamotor and tubes.....\$88.50
BEAM ROTATING MOTORS
 As described in August Radio News. Conversion data included.
 PRICE.....\$14.95
 Converted.....\$37.50

NAVY TDE-2 TRANSMITTERS
 Brand new, including tubes.....\$300 each
HS-30 STETHOSCOPE TYPE HEADPHONES
 Lightweight, comfortable to use.
 New.....\$1.75

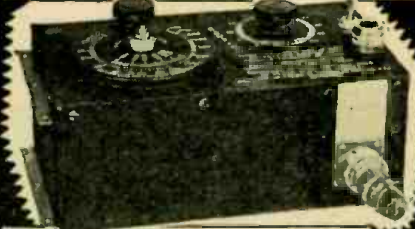
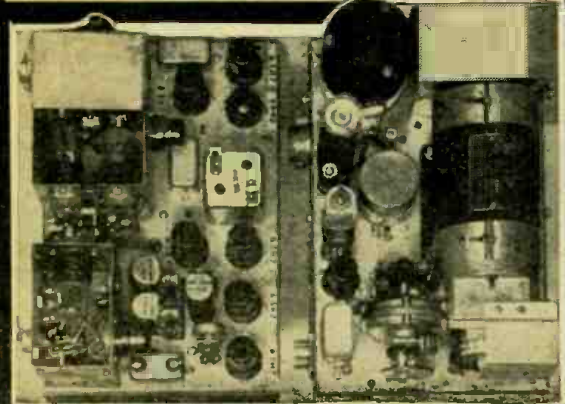

INTERVALOMETER
 Used to release bombs at pre-determined intervals—adaptable for use as a timing device in photography, etc.
 Price.....\$1.75 ea.

TERMS:
CASH
 with
ORDER

ESSE Radio Company

130 W. New York St. - Indianapolis 4, Ind.



BC-348 COMMUNICATIONS RECEIVER

This receiver will give outstanding performance wherever used. 6 bands, 200-500 Kc. and 1.5-18 Mc. Two stages RF, three stages IF, BFO, Crystal Filter, Manual or AVC. Complete with tubes and 24 V. dynamotor. Guaranteed. In excellent condition.

Price \$47.50

BC-348, 110 V AC Power Supply, including simple conversion instructions, complete with 6x5 tube \$9.95

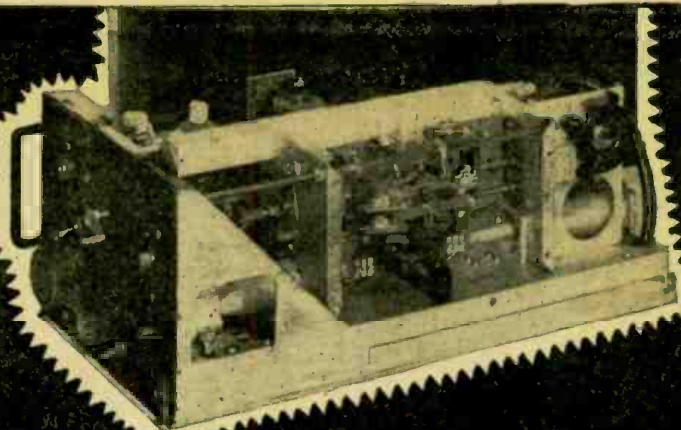

RADAR TRANSMITTER T-39/APQ-9.

Contains many excellent parts for the VHF experimenter such as a cavity oscillator using 2-RCA 8012 tubes rated at full output to 500 Mc. Tubes are forced air cooled by 24 V. DC motor, which is easily converted for 110 V. AC operation. Other valuable parts such as a pair of 807's, 2-6AC7, 1-931 and 1-6AG7 tubes; ceramic switch, potentiometers, gears, revolution counter, etc.

PRICE \$19.50



TURBO AMPLIFIER

Used for parts—shipped complete with the following tubes

- 2.....7 C 5's
- 1.....7 Y 4
- 1.....7 F 7

Price \$1.25 ea.



TELRAD 18-A FREQUENCY STANDARD.

Checks signals in the range of 100 Kc. to 45 Mc. with a high degree of accuracy. Self-contained power supply is 110, 130, 150, 220, and 250 V. 25-60 cycle AC. Complete with tubes, dual crystal, and instruction book. Brand new.

Price..... \$24.95

PANEL METERS — BARGAINS

Brand New in Original Boxes

- | | |
|---|--------|
| 1 0-500 Ma. DC, 3 1/2" Westinghouse..... | \$3.50 |
| 2 0-300 Ma. DC, 2 1/2" Westinghouse..... | 2.50 |
| 3 0-5 Amp. RF, 3 1/2" Westinghouse..... | 4.50 |
| 4 0-7.5 Volts AC, 3 1/2" Westinghouse..... | 3.50 |
| 5 0-3 Amp. RF, 2 1/2" Westinghouse..... | 3.50 |
| 6 0-10 Ma. DC, 0-300 Ma. DC—Combination,
2 1/2" Westinghouse or GE..... | 3.00 |
| 7 0-2 V. FS Rect. Type 2000 Ohm/V.,
Volume Level Meter, 2 1/2" Westinghouse..... | 3.00 |

BC-375-E TRANSMITTER, \$17.50

Transmitter only, including tubes and one tuning unit of your choice.

- | | |
|--|------------|
| BC-375 Transmitter Tuning Units in aluminum cases..... | \$3.95 ea. |
| TU-5B and TU-10B..... | 2.95 ea. |
| TU-6B, TU-7B, TU-8B, and TU-9B..... | 2.45 ea. |
| TU-26-B..... | 3.95 |
| Antenna Tuning Unit, BC-306-A..... | 4.95 |
| Dynamotor PE73-C..... | |

BC-357 MARKER BEACON RECEIVER

Ideal for controlling remote circuits for model aircraft, boats, etc. Operates from 75 mc. Signal easily altered to 2 meter band. Tubes used and included: 1-6SH7, 1-6SL7GT, 1-12SN7GT. Also sensitive relay. Circuit diagram included inside case. Size 5 3/8" x 3 3/8" x 5 1/4" For 24 V DC operation. Complete as shown.

Price..... \$1.95

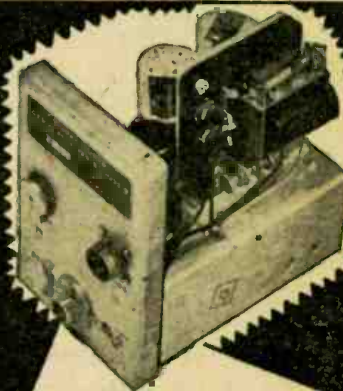

**TERMS:
CASH
with
ORDER**

ESSE

Radio Company

130 W. New York St. • Indianapolis 4, Ind.

SPRAGUE TRADING POST

FOR SALE OR TRADE—Radio repair, electrical supply & appliance store. Good Brooklyn corner. Will trade for same business in small middle western town. Send pictures to Consolidated Radio, 358 Saratoga ave., Brooklyn 33, N. Y.

FOR SALE—Semi-professional recording machine complete with mike, records and Radiotone built in amplifier. \$150; also slightly used Hallcrafters SX29A receiver. \$150. Harold R. Kurth, Hutchinson, Minn.

FOR SALE—R.C.P.-V.T.V.M. and insulation tester 665A, used only few times, \$60; Triplet tube tester 3212, \$50; Speco signal tracer, \$40 and Precision dynamic tube tester 910, \$40. Kubliis Radio Service & Sales, 1389 Russell Rd. N.E., Cleveland 3, Ohio.

WANTED—Condenser checker with neon bulb indicator, Greiner Radio, 114 N. Elmwood Ave., Buffalo 1, N. Y.

FOR SALE—AC Telex code instructor, seven tapes and directions; used very little, \$27.50. A. S. Daniels, 2633 Pemberton Drive, Houston 5, Texas.

FOR SALE OR TRADE—Hallcrafters 8-36 ultra high frequency receiver, 12" pm speaker in cabinet and extra set spare tubes, all like new for Hallcrafters SX-42 or similar receiver. R. M. Matyas, 739 W. Green St., W. Hazelton, Pa.

FOR SALE—RCA service manuals 1920 through 1941, \$12.50; 4 Silverstone manuals, 1928 through 1941, \$9; G-E manual 1930 through 1935 with cross-reference for RCA Westinghouse & Graybar, \$5; Hammelund Comet Pro. 9-tube AVC receiver with coils and speaker, \$45; Belmonts most often used diagrams 1926-38, 39, 40, 41 and 42, \$8; SW3 with coils and power supply, \$20; SCR-211 ac frequency meter 125 to 20,000kc. complete with xtal and technical manual, \$30. Will trade 2, RK20; 2, 832, 2, 211 new, and 2, 80.8, 2, 213, 1, 242A guaranteed, also 2, 5FP1; 2, 5FP7; 72, 2API cathode ray tubes. Daugherty Radio, 5020 Hohen St., Dallas, Tex.

FOR SALE OR TRADE—1 Super meter 670, very little used, \$20 or what have you? John R. Reagan, 1218 9th St., N.W., Canton, Ohio.

WANTED—Rider manuals, good condition. All letters answered, Norman A. Tibbets, Box 12, Bristol, N. Hamp.

FOR SALE—Precision E-200 signal generator and 920P tube and test tester; \$275 in tubes; \$125 in parts; set equipment used but slightly, \$300 for lot. Mill Radio Service, 345 Mill St., Williamsville 21, N. Y.

FOR SALE—Quantity of insulated resistors in all sizes and wattages, condensers, coils, etc. All new, at real bargain prices. Send for list. Technical Radio Lab., 341 Wilson Ave., Brooklyn 21, N. Y.

FOR SALE OR TRADE—N.R.I. course with equipment, \$60; without equipment, \$50; also A.T.R. Inverter 75 watt 6v d-c to 110v a-c, \$20; nearly new, or would trade course for tube tester. Marline Sigler, Shady Grove, Ky.

FOR SALE—RCA Rider channel, never used, \$120; Rider manuals 6, 9, 10 and 11, perfect, \$12 ea., and Triplet combination signal generator and VOM, good condition, \$35. Howard T. Bailey, R#4, Harrisburg, Ill.

WANTED—Serviceman capable of taking charge of service department. Must be sober, honest and capable. Good opportunity. Southern Radio Service, Thomasville, Ga.

DOUBLY SEALED AGAINST HEAT and MOISTURE

Sprague High-Voltage Paper Tubular Vibrator Condensers are especially designed in every respect to stand the severe conditions of auto radio operation. They're oil impregnated against intense heat. They're over-all wax dipped—and they've got special end seals for really top notch humidity protection. The working voltage rating of 1600V.



D.C. is honestly conservative. Capacity ratings mean exactly what they say.

Use 'em on all auto radio jobs—and other high-voltage applications as well. They'll stand the gaff! They will not let you down!

As always, we'll appreciate it if you order them by name—*Sprague Type TR High-Voltage Paper Tubulars.*

SPRAGUE VIBRATOR CONDENSERS

FOR SALE—Rider manual vol. III like new; also few used tubes. Dick Brance, R#3, Charlotte, Mich.

FOR SALE—Meissner 3-tube ac-de radio, \$12. Portable electric megaphone amplifier (with batteries, schematic, in metal box, shock mounted, carrying straps, etc.) but less megaphone unit and four tubes, \$30. Also DM-32-A dynamotor \$10. Scott Gibson, 1357 3rd Ave., San Francisco, Calif.

FOR SALE—New 5" Black and white television tubes RCA 5B94, 1802P4, \$5. Globe Radio & Sound Service, 106-10 New York Blvd., Jamaica 5, N. Y.

WANTED—Pair Baldwin balanced armature earphones or W.E. 705A or 711A. Walter P. Menkhaus, 1211 W. Butler St., Philadelphia 40, Pa.

FOR SALE—Silver-Marshall TRF, 9-tube radio chassis model 30, 4 stages r-f, 4-gang condenser, 3 tubes output, 2 filter chokes, 1 audio-transformer, \$10. Henry Skorlowski, 1501 Crown Ave., Scranton 5, Pa.

SELL OR TRADE—Complete transmitter kit 80-160 crystal power supply wired; also parts and tubes. L. Plante, RFD, Box 170, Manville, R. I.

WANTED—Pair of transceivers 152-162mc. one for mobile and the other for stationary operation. Have for sale—250 ohm 1-watt resistors 5% tolerance and cardboard record racks holding 30 records, individually packaged, 32c ea. Harris Supply Co., 1336 W. Chaso Ave., Chicago 26, Ill.

URGENTLY NEEDED—Shure 717B hand mike in good condition. Will pay cash. Please state price when writing. Must be complete with cable ready for use. C. B. Cowper, 58 Rhyl Ave., Toronto, Canada.

FOR SALE—Used 115v ac transformers; 14,000V @ 25ma, \$6; 8,500-v @ 20ma; \$3; 2350v rectifier @ 200ma like new, \$3; T. Wohlwender, 17 Sixth St., Fon du Lac, Wisc.

WILL TRADE—Tube tester meter; tube tester transformer; General Motors speaker d-c 9" for 4" magnetic speaker; new or used 1D8GT and 1T4 tubes. Arthur Bulmer, 90 South Main St., Rockland, Me.

FOR SALE—Professional post card and picture projector, like new, \$20. Robert Brooks, Swarthmore, Pa.

WANTED—Catalogs and technical details of all-American radio and electronic components and equipment. Sam Murphy, 12 Commerce St., Elgin, Scotland.

SELL OR TRADE—Bud code practice oscillator, \$15; N & K German headset 4,000 ohms, \$8.50; Baldwin "Type C" headset, \$15; Music Master, \$10; Hallcrafters fm converter, \$15; ATR inverter 110dc to 110ac, 250w, \$37; Siemens-Halske German field radio, 3 band 110/ac/dc, \$50; Shiek Colonel and Super electric razors, \$15 and \$18; Shaverest, \$7.95 and Revere Chime clocks, \$96. Want gasoline electric unit 110v 60 cy, 250w to 1 kw. Kay Electric Megaseep generator, Rider Channelist, R. G. Devaney, 631 S. 60th St., Philadelphia 43, Pa.

FOR SALE—BC-348-R converted to 110v a-c with "S" meter and new set of knobs, \$80. Also BC-645 partly converted to 420 mc., \$15. Bill Pemberton, 207 Scott St., Wheaton, Ill.

FOR SALE—National NV variable vernier solid nickel dial and type BM vernier dial; W.E. type 15B main line sounder; Omnitone 15-ohm, 25-watt variable T pad. In new condition; 1/3 list prices. Philip Ross, P. O. Box 905, Hoboken, N. J.

SELL OR TRADE—Vacuum tube voltmeter and signal tracer complete with all leads; also tube testers, Hickok 51X in excellent condition and a home built unit. All replies answered. James W. Hoskins, 212 Middlefield Rd., Palo Alto, Calif.

SELL OR TRADE—Rider manuals abridged 1 to 5 and from 6 to 13 inclusive; also Servicing by Signal Tracing, Worth \$137.50. Will sell for \$90 or Hallcrafters \$40A. Linden A. Teague, 109 Bullvar St., Canton, Mass.

FOR SALE OR TRADE—150 tubes in 6 and 1 volt series, Loose packed. New. Cash or what have you? R. Rupp, 35112 Cowan, Plymouth, Mich.

WANTED—Modern tube tester with adapters; standard all-wave signal generator; and modern VOM tester. Kelson's Appliance Service, 149 Eagle St., North Adams, Mass.

FOR SALE—Superior signal generator \$50; Spenco signal tracer amplifier with probe, model STAP; Supreme master radio Diagonometer; Precision 844 multi-range tester and Superior 450 tube tester. Will sell as lot or separately. Albert Valione, 273 East 151 St., Bronx 51, N. Y.

WANTED—Home recorder or radio-recorder in good condition ready to use complete with amplifier and mike. Paul Aupied, 1669 N. Dorsgenois St., New Orleans 10, La.

FOR SALE—Signal generator like new, RCP 765, \$40. James E. Boren, Box 1043 Commercial St., Station, Springfield, Mo.

SWAP OR SELL—Mark II tank transceiver complete with spare parts. R.H. New. Sell for \$38 or trade for set analyzer, tube tester, frequency meter, or other ham transceiver. Elton S. Gamble, 202 Westfield Ave., Ansonia, Conn.

FOR SALE OR TRADE—Proceedings of the IRE 1944 to present. Complete except for March and April, 1944. Want 0-500 AC wattmeter, 0-15 DC voltmeter, 0-10 DC ampmeter or sell for \$20. Walter D. Cummings, 911 Shawnee St., EE, Pitts-burgh, Pa.

FOR SALE—Tubes worth \$343; 7 Radiart vibrators; 11 Solar dry electrolytic and 2 crystal pickups. Will sell lot for \$340. Paul W. Rohwer, Ophir, Colorado.

SELL OR TRADE—Crystalline oscillator, \$40; need Rider manuals 11-12-13. La Feria Radio & Appliance Service, P. O. Box 868, La Feria, Texas.

FOR SALE—Practically new Hogen 30-watt amplifier E30; 2-University PII reentrant speakers and 2 BAH driver units, 25-watts; 1 Turner 211 crystal microphone with cable and floor stand and Hogen 8016 dual-speed 114" turntable, \$200 complete. Star Radio, 114-42 Merrick Blvd., St. Albans, N. Y.

WANTED—IP transformer for Clarion 220. Meissner replacement, 20-3478. Alme A. Blanchard, 5 Cedar St., Waltham, Mass.

SELL OR TRADE—National NC240D, with matching speaker, latest model, new, \$195; Hammelund HQ129X, used about a month, \$145; New Navy LM17 frequency meter, calibrated with original crystal and a-c supply, \$75. R. Yeager, 4423 Sheridan, Chicago, Ill.

SELL OR TRADE—Emerson 3-way portable with earphone attachment in home-made cabinet, \$80 or what have you, James Smith, 2362 Stillwell Ave., Coney Island, N. Y.

YOUR OWN AD RUN FREE

The Sprague Trading Post is a free advertising service for the benefit of our radio friends. Providing only that it fits in with the spirit of this service, we'll gladly run your own ad in the first available issue of one of the six radio magazines in which this feature appears. Write CAREFULLY or print. Hold it to 40 words or less. Confine it

to radio subjects. Make sure your meaning is clear. No commercial advertising or the offering of merchandise to the highest bidder is acceptable. Sprague, of course, assumes no responsibility in connection with merchandise bought or sold through these columns or for the resulting transactions.

DEPT. RC-97, SPRAGUE PRODUCTS COMPANY

North Adams, Mass.

(Jobbing distributing organization for products of the Sprague Electric Co.)

ASK FOR SPRAGUE CAPACITORS and *KOOLOHM RESISTORS by name!

*Trademark Reg. U.S. Pat. Off.

PRINTED RADIOS

Printed Radio Components - The Coming Big Radio Development . . .

By HUGO GERNSBACH

WHEN radio was young and known as "wireless," we used to buy our various radio components, tubes, variable condensers, tuning coils, etc., and assemble them on a breadboard. We then proceeded to wire the components in exactly the same manner in which electrical instruments always have been wired. In the early days practically all radio components had some sort of binding posts to which connections were made. Soon when hundreds of thousands of people wanted radio receivers, the same components were still used, but the binding posts and screw connections no longer could pass muster. The reason was that such connections were not sufficiently good electrically and soon became loose due to temperature variations, vibration, etc. Then the set became inoperative.

The binding posts now gave way to the soldered connection. This proved a step forward because such connections were made faster; dozens of connections were quickly made once the soldering iron was hot. This method is still in vogue today under mass production conditions of radio set manufacture.

Later on when it became necessary to turn out thousands of radio receivers daily, radio manufacturers borrowed a few tricks from the automobile makers and began to assemble radio sets on an endless belt where special operators, standing along the production line, made a few soldered connections as the radio chassis moved by them.

The solderers had to work fast, and at the same time the soldered connections had to be perfect, too. Thus we see the modern radio chassis moving on long belts, each operator doing his assigned part until the final, completely assembled and soldered chassis comes off the production line, which then goes to the testing benches.

During the war, when speed in assembling and compactness of certain radio and radar sets became a paramount consideration, new ways and means had to be developed in order to turn out a rigidly perfect product in a minimum of time.

Engineers pored over already existing patents to find ways and means to do away with wiring entirely. In their search they came across a number of patents dating back to the early 30's wherein some inventors had foreseen just such an eventuality and had patented solderless and wireless radio receivers. These inventors recalled that it was not necessary, for instance, to use a three-dimensional resistor because in the early days of radio when the audion first was invented by de Forest, a high-resistance grid leak, having a resistance of several hundred thousand ohms, was fashioned in a very simple manner. All that was necessary was to trace on a small card, such as a visiting card, a heavy pencil line and then make connections with two brass clips on each side of the pencil line. This pencil line was the resistor. Later on the pencil line gave way to an India ink line

traced by means of a pen on paper. Connections were made with metal clips, or similar means.

But it was a laborious process to trace such lines, particularly if you needed a lot of resistors. So in the early 20's the present writer, then owner of the Radio Specialty Company of New York, started to sell small cards, impregnated with a special carbon ink. These 3" x 4" cards were sold at the low price of 15c. You merely cut off strips for various resistances. Thus a strip $\frac{3}{4}$ " long by $\frac{1}{8}$ " wide gave exactly one megohm. This probably was the first printed radio component.

Later on engineers began to think along parallel lines. The idea of printing the wiring and various other components no longer seemed far-fetched. It was found, for instance, that you could take a sheet of bakelite, or other plastic, and electroplate such a sheet with a maze of connecting lines in order to fashion a "chassis" on which radio parts could be screwed down. The electroplated lines had now become the connecting wires.

Several other methods were developed in addition to electroplating. A number of prominent ink houses found that an intricate mass of wiring could be printed on an insulating sheet by means of a special high-conduction ink. These printed ink lines were the connecting wires. If certain of the lines were not sufficiently conductive to carry the necessary amount of current, the ink lines could be plated or sprayed with copper or other metal.

Another process tried was that of depositing metallic silver on an insulating sheet. The silver can be deposited chemically or electrochemically; it can also be painted on ceramics.* Silver being our best conductor, a very good connection was thus fashioned, in fact, as good as a solid copper wire.

By means of these various methods an entirely new art is now being developed. The radio chassis of the future will have all its wiring permanently printed in place. Then when the chassis comes to the assembling line the radio receiver can be put together in a small fraction of the time it takes to do by the present methods.

Inventors found that while it is easy to print or plate on an insulating sheet, more difficult is the problem of lines that must cross each other. Naturally, you cannot print or plate cross "wiring-lines" on the same surface, because this would cause short-circuits.

Inventors got around this by placing the connection lines on *both sides* of the sheet. Thus there can be no short-circuit, yet all the "wiring" can be put in place. Now when two connection lines cross each other, they cross with a solid sheet of insulating material between them.

After that problem was solved, radio engineers asked themselves why they should stop with the connection lines. So they began to evolve *printed components*. Just as the writer originally

(Continued on page 68)

*See article "New Subminiature Printed Circuits," June, 1947 RADIO-CRAFT.

JAMES G. HARBOARD president of the Radio Corporation of America before 1930 and since that time chairman of the Board, retired under RCA's regular pension plan on July 11. David Sarnoff was elected to serve in his place as chairman of the Board as well as president of the corporation.

The retiring chairman also held the rank of lieutenant general in the United



States Army, which he entered as an enlisted man in 1889, rising to the rank of major general during the first World War. His promotion to lieutenant general came in 1942.

At the same time, Orrin E. Dunlap, Jr., was elected vice president in charge of advertising and publicity. Mr. Dunlap has been with RCA since 1940, serving first as manager of the Department of Information, then as director of advertising and publicity. He was radio editor of the *New York Times* for 18 years, and is the author of 10 books on radio, radio advertising, television, radar, and related subjects.

PROXIMITY FUZES which were operated by light instead of radio waves were used on rockets during the war, it was disclosed last month by Frank A. Zupa of Bell Telephone Laboratories. The "seeing-eye" fuze functioned when proximity to the target cut off part of the light which normally reached it.

Essential parts of the device were a ring-shaped lens built into its nose, a photocell, an amplifier, and a selective switch. When the rocket was fired, the selective switch armed the fuze by throwing the amplifier into circuit.

While the rocket was in flight, daylight entering through the lens and striking the photocell maintained a certain level of current that did not activate the detonating mechanism. As the missile approached its target, however, some of the light was cut off by the target itself, and the resulting change in current level served to set off the explosive charge.

Apparently this type of fuze was useful only during the day, and would not be useful in conditions of twilight or darkness.

RADIO-ELECTRONICS

Items Interesting to

PAY-AS-YOU-SEE television was proposed last month by Commander E. F. McDonald, president of Zenith Radio Corp., as a means of solving the economic problems of television broadcasting.

According to the plan proposed by McDonald, scrambled television signals would be sent through the air to the receiver in the usual fashion. Special unscrambling signals would be sent over the telephone wires, to which the set would be connected. To receive the program in intelligible form, the user would call the telephone operator and ask for "Phone-Vision." Payment for the television service could then be made through the telephone company, much as for a long-distance call if arrangements can be made with the 'phone companies.

The subscriber's telephone could be used for ordinary calls while receiving a program, without interference either to the program or telephone conversation.

Commander McDonald states that experimental transmissions have already been made, and that technically the system is quite successful. Telephone officials point out, however, that there might be legal obstacles, at least in some states.

CITIZEN'S RADIO is about to come out of the blueprint stage, a last month's *Science Service* report states. Fifty manufacturers and experimenters are already talking on the allotted 460-470 megacycle band under experimental licenses. About 500 small portables are already in use by police, firemen, foresters, geologists, and motion picture producers.

Radio engineering advances made during the war are helping to speed the day when such personal radio-telephone sets can be bought and when the FCC will allow them to be used. Printed circuits, in which metallic paint on plastic or ceramic plates replaces conventional soldered wires, will make the new sets lighter and smaller. Miniature tubes, such as used in the famous wartime proximity fuzes, will in some cases replace 3 or more tubes of conventional prewar radio sets.

Manufacturers are not yet ready to guess at what these Citizen's Radio Service sets will cost. Probably they will be in the price class with the better kind of living-room radio.

You can't yet apply for a license to operate a citizen's radio because the rules and regulations are not yet drafted by the FCC. The new service probably will not be legalized before early next year.

RADAR terrain-clearance indicators will be required on all air lines for a 2-year experimental period beginning January 1, 1948, the Civil Aeronautics Board indicated last month.

Several devices are competing for the selection as approved equipment, among them being the new Hughes lightweight clearance indicator, the light Army radar described in *RADIO-CRAFT* last March, and a similar radar developed jointly by the Navy and American Airlines.

ADVICE to young scientists not to take too much for granted because it is backed by authority was given by Dr. Harvey C. Rentschler on his retirement as director of Westinghouse lamp and electronic tube research last month.

"The best research engineers I have known," he said, "have been those whose minds are open to conviction and who are able to make their own decisions. Just because something is stated as a fact in the scientific literature is no positive proof that it is a truth. Formulas, equations and rules were made to be challenged and exist only because someone challenged former rules."

LARGE-SCREEN television is about to make its commercial debut, a last month's report issued jointly by RCA and Warner Brothers Pictures states.

The large-screen video will be introduced in a Broadway theater by Warners and may also be piped into other theaters operated by the company. Preliminary tests made by Warners and RCA indicate that spot news and special events coverage lend themselves to theater presentation, and the television feature will be presented in conjunction with other newsreel subjects.

Another large-screen commercial television installation is proposed at the Monte Carlo Swimming Pool at Asbury Park, N. J. A screen 6 x 8 feet is to be used.

The screen is said to offer a new form of direct projection from the face of the tube to a brighter-type screen. The life-size projection will give its audience day and night baseball, boxing and wrestling, as well as any other important events televised in course of the season.

TELEVISORS FOR RENT are being offered by a New York City service concern. The rental cost is \$2.50 per day, and a week's service is the minimum permitted.

Under the plan, television receivers are delivered, installed and picked up anywhere in the metropolitan area.

MONTHLY REVIEW

the Radio Technician

VACUUM LEAKS may now be detected by a new ionization gage tube which permits one gas to pass while holding back all others, according to a release issued last month by RCA. The new tube, RCA1945, is sensitive to hydrogen only. It features a palladium plate which, when hot, is porous to hydrogen but acts as a vacuum-tight barrier to all other gases and vapors. In operation, the tube is connected into a vacuum enclosure or system to be checked for leaks. A tiny jet of hydrogen is then played over the outside areas of the suspected system. Any leaks will suck in the hydrogen which then runs down to the tube, passing through the palladium plate and causing an increase in the ion current inside the tube. This increase in current is amplified and indicated on a microammeter. Tiny leaks, so small that molecules of air barely pass through them, can be detected by the tube, which is sensitive enough to detect an increase in hydrogen pressure of less than 0.0000001 mm of mercury.

Radio Items of the Month

Ultimate in radio service was offered recently by the Radio Center of Yonkers, N. Y. An advertisement of that company carried the following:

"ATTENTION

To the Thieves Who Stole My 22 Radios

Remember, We Guarantee Our Radios Whether You Buy or Steal Them.

The Management"

Facsimile transmission capable of sending a million words a minute was revealed last month by Niles Trammel, president of NBC. The equipment, under development by RCA, combines present facsimile and television techniques.

Deafness tester which uses a 2-toned whine to tire normal ears and temporarily dull their receptivity was reported last month by Dr. Mark B. Gardiner of the Bell Telephone Co. The test is designed to determine the type rather than the extent of deafness.

Television equipment is being constructed to be used underwater at the site of last year's Bikini atom-bomb explosion. It will be used in a scientific survey of the results of the underwater bomb explosion.

Diathermy equipment which causes radio interference is no longer permitted to operate in the United States. The owner of any such equipment must either modify it to comply with FCC regulations or cease operating it altogether.

Television broadcasts now cover territory inhabited by 25,000,000 people.

TELEVISION which permits the parties in a telephone conversation to see each other was reported from Russia last month. The face of the person at either end of the line is shown on a small screen. The image is picked up by a lens beside the video screen.

The device is the invention of I. P. Zakharov, a staff worker of the USSR Television Research Institute. He calls his invention a videotelephone. A number of the devices installed at the Institute are reported to be working satisfactorily.

If successful, the videotelephone will fill a long-felt need, as some of the very earliest concepts of televisions were of instruments which would permit adding vision to sound in ordinary telephone conversation.

AUSTRALIAN reception of American FM stations was not due to improved or "new" receiving apparatus, as early newspaper reports implied.

Queried on the subject, Radio-Craft's Australian correspondent, John W. Straede, states: "I spoke to Mr. Graham, who with his brother runs a radio shop in Melbourne. He tells me the radio is a standard FM-AM receiver with nothing new or startling, and that reception on the longer wavelength FM bands (30 to 40 mc) is fairly consistent in the summer.

"The stations received are mostly police and emergency services such as fire brigades."

A PERFECT ROBOT has been the dream of scientists throughout the ages. This dream may be a little nearer to realization as a result of progress with electronic "thinking machines." At least some of the men who helped design and build these machines think so.

Says Professor Norbert Weiner of the Massachusetts Institute of Technology: "I defy you to describe a capacity of the human brain which I cannot duplicate with electronic devices." Professor Edwin G. Boring, director of Harvard's psychological laboratory, is willing to go even further: "... it should require only a matter of time, patience and continued support from some foundation," he says, "to design a bright and attractive dinner companion or eventually even the perfect professor of psychology."

TELEVISORS for rent are being offered by a New York City service concern. The rental cost is \$2.50 per day, and a week's service is the minimum permitted.

Under the plan, television receivers are delivered, installed, and picked up anywhere in the metropolitan area.

FM PRODUCTION is on the increase, Arthur Freed, treasurer of the FM Association, reported last month. Between 15 and 20 manufacturers who have produced only AM receivers up to the present expect to start manufacture of FM sets before the end of the year, he said.

According to the same report, more than 700 FM stations will be in operation before the end of the year, and 80% of the country's population will be within range of at least one FM station.

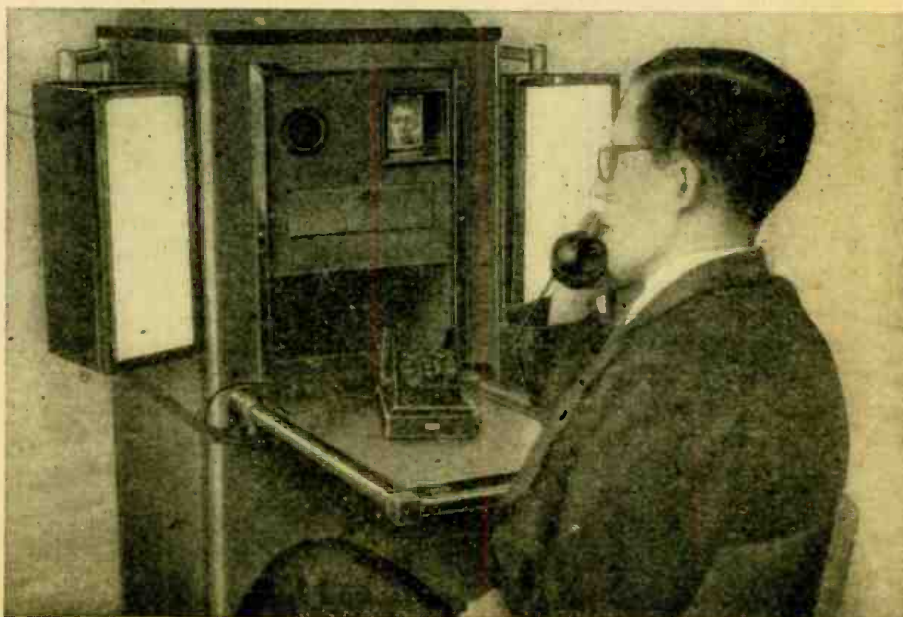

Mr. Sakharov using his telephone-televiser in the USSR Television Research Institute.

Robot Makes Radios

Electronic component making equipment may revolutionize the manufacture of receivers

By MAJOR RALPH W. HALLOWS

A NEW and entirely mechanical process for producing radio receivers at a rate of 1 every 20 seconds has been developed and put into use by John Sargrove, Ltd., at Walton-on-Thames, near London, England. All components except tubes, large iron-cored transformers, electrolytic capacitors, and loudspeakers are "grown" on a bakelite panel as it passes through a machine.

The new process known as *E.C.M.E.*, *Electronic Circuit Making Equipment*, differs in many ways from systems using printed, deposited, or sprayed conductors. The whole process is mechanical: One operator feeds bakelite blanks to a conveyor belt at the input end of

the 70-foot long machine (Fig. 1) and a second, at the output end, inspects the finished panels as they emerge. Every stage of the manufacture is electronically controlled; each part of the machine starts automatically when work comes in on a conveyor and stops automatically if it has nothing to work on. Automatic cutouts operate if a fault of any kind develops in any section.

The basis of the *E.C.M.E.* system is that an entire circuit is built on a pre-formed bakelite blank, which serves as the panel and as the dielectric of capacitors, the formers of coils and the insulation between conducting paths. Fig. 2-a shows a typical ebonite blank, with depressions of various shapes and sizes

molded into it. The straight grooves will eventually become the conducting paths which take the place of wiring; a large spiral will become a coil; the circular depressions, plates of fixed capacitors; the rectangular depressions, the fixed plates of compression-type variable capacitors. Figs. 3, 4, and 5 indicate how this is accomplished. When depressions are molded opposite each other on both sides of the plate, as at (B) in Figs. 3 and 4 and (A) in Fig. 5, a thin web of bakelite is left between them. Metal-sprayed on both sides, this web is made into the dielectric of a fixed capacitor. The straight grooves become connecting paths; the spiral grooves become coils when metalized. The connectors are made to cross by being placed on different sides of the panel. The connection from the inner end of the coil is brought out on the opposite side of the panel, (C) in Fig. 3. The connection is made with a metal eyelet passed through the panel and clinched. A similar connection is seen at (D) in Figs. 3 and 4. Eyelets and contacts of rotary switches, (E) in Fig. 3, and tube sockets (F) are inserted mechanically. Resistors G1, G2, G3, G4, in Fig. 3 are made by spraying graphite into grooves of suitable size and shape. Low-wattage resistors of high value occupy narrow zigzag grooves. Wide grooves are used for high-wattage resistors. In practice resistors from 1 ohm to 10 megohms are readily obtained. Lower values dissipate up to 20 watts. The small portion of a panel in Fig. 3 contains resistors, capacitors, an inductor, a rotary switch, and a tube socket. By the *E.C.M.E.* process each of these components is "grown" simultaneously and automatically on the panel. The only manual operation is inserting the switch.

The machine used in the process is built of a number of self-contained sections. Different combinations of sections can be adapted for particular jobs. If a fault develops in any section of the machine, electronically operated controls stop the section affected and all sections preceding it. The following sections continue to operate to minimize delays in production.

The blanks of Fig. 2-a are fed by the input operator to a conveyor belt. This delivers them to the grit-blasting compartment which removes the outer skin of bakelite. A second conveyor takes them into the metal sprayer where they are under fire from twin batteries of metal-spraying pistols, one battery dealing with each side. The spraying pistols

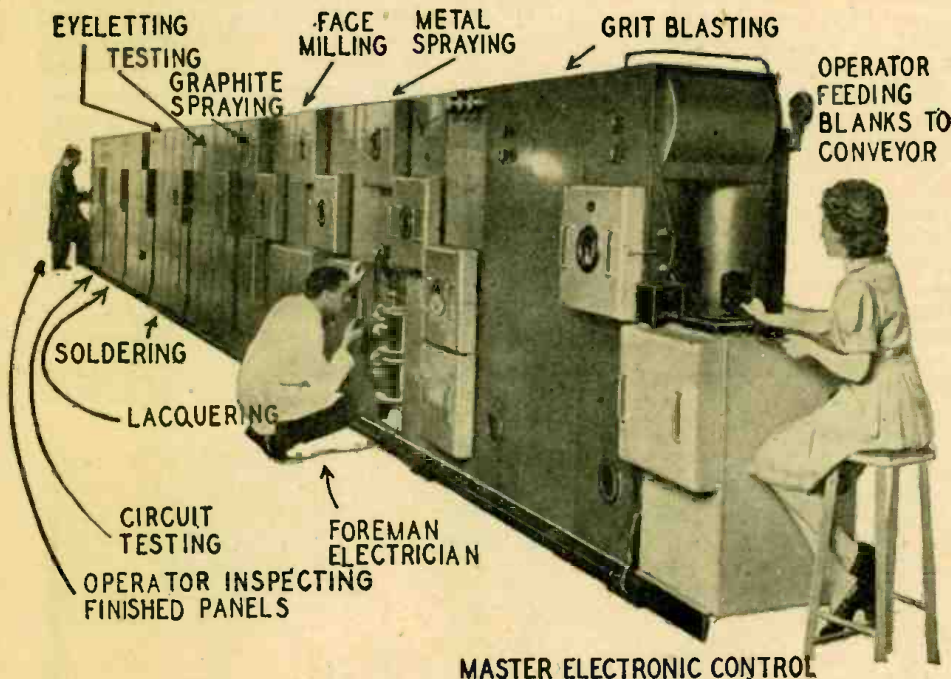

The 70-foot electronic circuit making equipment is automatic; it requires only 2 operators.

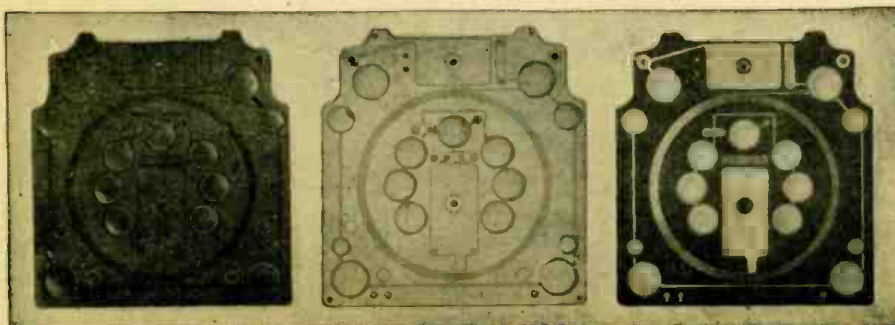

Fig. 2-a (left)—Molded blank; 2-b (center) after spraying; 2-c (right) after face-milling.

are of the wire-fed type, zinc wire being used. The entire surface of both sides is covered with a thin film of deposited zinc (Fig. 2-b). If the panel contains grooves for resistors, these will have been masked automatically during the metal-spraying process. Face-milling takes place in the next section. This is done by 2 batteries, each with 3 milling heads provided with diamond cutters. This operation removes all of the deposited metal except that lying in the grooves and depressions, and the panel now has the appearance seen in Fig. 2-c.

In the next operation, a set of automatically operated masks covers all of the panel except the resistor grooves during the graphite-spraying process. These masks are mounted on discs whose rotation is electronically controlled so that a clean mask is always provided.

Tests are made automatically in the next section, and any faulty panels are rejected. Eyeletting is done in the following stage; this includes the insertion of switch and tube socket contacts. E.C.M.E. sets have no joints depending entirely on solder. But solder is used to assure good connections at the few points where eyelets or other through-panel contacts are clinched. The process is entirely automatic.

The final step in construction for this type of machine is the lacquer-spraying of the panel, which covers the entire circuits with a protective layer. If tropicalization is required, this is easily and effectively accomplished by using a coating of a suitable plastic instead of lacquer. A final elaborate circuit test is made automatically in the last section of the machine.

The panels emerge, still on edge, at the output end of the machine and topple gently on to a horizontal conveyor, which takes them to the operators who perform the few manual assembly tasks necessary. All prefabricated components, such as electrolytics, large transformers, and loudspeakers, are designed so that they can be plugged in and clinched in sockets provided by the machine. The only other piece of manual assembly is to connect the various panels to each other. This is done by metal rods, plugged in and clinched to form spacers and electrical connections between panels.

In the E.C.M.E. system, radio sets are built from numbers of small panels connected in the way described. Apart from its convenience in the machine, the system has other important advantages. The cost of individual panels is trifling. Should a breakdown occur in a receiver, the serviceman, having tracked the fault to a particular panel, simply fits in a replacement and throws the defective unit away. Fig. 6 shows a 2-tube receiver made up of 2 panels and a cabinet.

Sargrove is limiting production to a simple 2-tube, plus rectifier, a.c.-d.c. receiver. Materials are in such short supply in England that a new firm has little hope of obtaining the necessary government permits unless it proposes to manufacture something for which there

is a ready export market. Undoubtedly there is a market, notably in the Middle East and Far East, for a small receiver which can be produced at a very low price. The simple 2-tube set with antenna coil and tickler does not represent all that the system can produce. On the contrary, Sargrove and his assistants are designing superheterodynes and television sets for manufacture by E.C.M.E. methods as soon as the supply problem becomes easier.

By this time the reader no doubt will have a number of queries. Inductors, for example. Can coils of reasonably good Q be produced? High-Q coils would be out of place in a small regenerative receiver; but with the simple methods employed a Q of 70 is readily obtained. Very much higher Q's have been produced in special ways, which I am not at liberty to describe. Can sufficient inductance be obtained in sprayed-on coils for them to form the primaries and secondaries of i.f. transformers? One of the most promising methods is to use an iron-dust filler for the panel in appropriate areas. What about tuning? Can it be made fine and sharp? It is hardly that in the present small model, which has 3 preset positions on the broadcast band. But new types of tuning with good performance and which lend themselves to E.C.M.E. production methods are being developed. The larger receivers of the future will probably have a form of permeability tuning.

Next, capacitors. What kind of capacitance values can be obtained from sprayed-on types? Fig. 7 shows a most successful method of obtaining capacitance values up to $0.0005 \mu\text{f}$ by corrugating the webs in the blank. There are 2 methods of obtaining higher values without completely sacrificing mechanical methods of manufacture. One is to build a capacitor (the rest of the panel being masked) by alternate sprayings of metal and of material of high dielectric coefficient. The second method is to use a subpanel of material with a high dielectric coefficient. By either method capacitances up to $0.03 \mu\text{f}$ are obtainable. If larger capacitors are needed, they are plugged in and clinched in the way already described.

E.C.M.E. may play an important part in the manufacture not only of radios but of many other kinds of light electrical equipment. You don't have to do much thinking to realize how many fields may be open to it. In radio manufacture some of its biggest advantages are the following:

- (1) A plate containing 20 sprayed-on components is no more expensive to make than one containing 10 or 12. An additional component of this kind, in fact, adds nothing whatever to the cost. There is no need for a designer to cut down components, such as capacitors, resistors, or chokes in order to keep within production cost limits.
- (2) No wiring mistakes can be made by tired or careless operators. There can be no variations, large or small, in the length or position-

ing of conductors, since the human element is eliminated.

- (3) Radio sets can be manufactured more rapidly and far more cheaply than when prefabricated components are assembled on a chassis and wiring is done by hand.

(Continued on page 81)

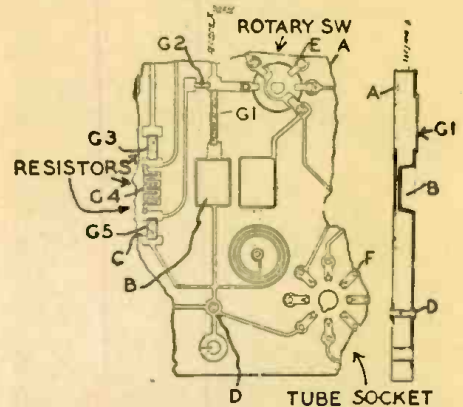

Figs. 3, 4—Plan and section of part of panel.

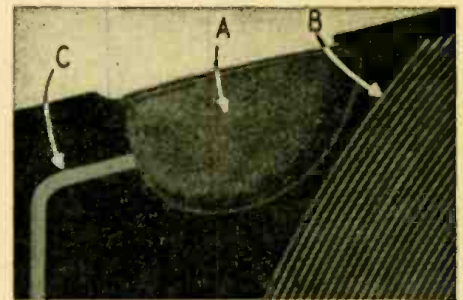

Fig. 5—A, capacitor; B, coil; C, conductor.

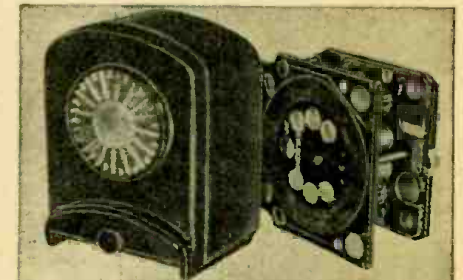

Fig. 6—Complete 2-tube-and-rectifier radio.

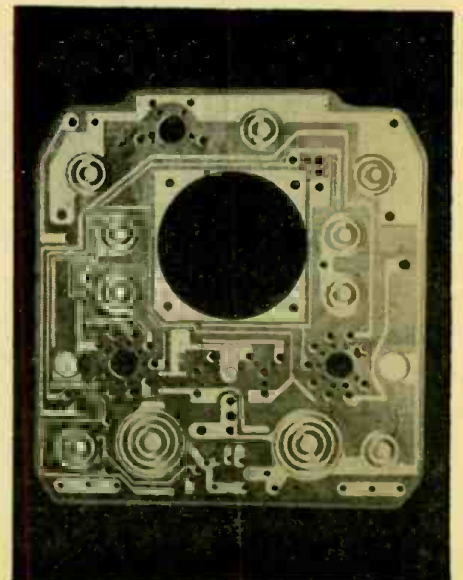

Fig. 7—Corrugated discs are capacitor forms.



The inventor demonstrates the egg grader.

ELECTRONICS, the science which accomplishes anything from interrupting the tread of a sleepwalker to operating a burglar alarm, has been harnessed as a novel method of grading and sorting eggs.

The inventor of this time and labor saver is Professor Alexis L. Romanoff, poultry authority at the Cornell University Agricultural Experiment Station, Ithaca, New York. He developed the electronic method through research on egg fertility extending back to 1938. In the process of studying thousands of eggs, certain peculiarities due to quality were observed. Some of the differences between fertile and infertile eggs, for example, were so small that a new method had to be devised to determine them.

COVER FEATURE:

ELECTRONIC EGG GRADER

By S. R. WINTERS

Although it does not now reveal blood spots if present, still making one candling necessary, the electronic method is a decided improvement over the best system previously devised, of holding the egg before a light to determine the grade. Electronics can now sort eggs more accurately according to their future perishability and their internal quality, reducing the number of times an egg must be graded. For instance, in 1943, about 54 billion eggs were produced. All of these had to be sorted at least once. Nearly all market eggs (over 50 billions) were graded several times by various agencies, including thousands of egg packers, wholesalers, receivers, distributors, jobbers, brokers, and egg auctioneers. Cold storage operators especially have to grade eggs before and after holding.

The Romanoff method consists of placing the egg in a coil lying in an electromagnetic field of radio frequency. In this field the current passes through the egg. A meter records the amount of power absorbed by the egg, and grades it accordingly, the best eggs having the highest conductivity. The dial can be calibrated to suit any grad-

ing system, from showing the finest distinction, to merely "good, medium, poor."

The apparatus (Fig. 1) consists of a 5-watt oscillator on approximately 14 megacycles. Its tank is link-coupled to a coil in which the egg is placed. The egg coil has a galvanometer in its circuit, and differences in the galvanometer current can be interpreted in standard egg grades. Besides having a higher conductivity, strictly fresh infertile eggs show a tendency toward a lower dielectric constant than fertile eggs.

Various indicators

In another form of the equipment, the egg coil has a small lamp at a nodal point. The r.f. picked up from the oscillator through the link is adjusted to keep the light at a given brightness. Changes in brightness when an egg is placed in the coil are noted by a photocell, which is connected to the indicating meter. This method recently has been abandoned in favor of a pickup coil with a crystal detector wired to the galvanometer.

Since the weight of an egg is a factor in determining its grade, a means is provided for weighing each egg and indicating the weight together with the conductivity. The total of the two indications is then indicated by the meter.

In the model illustrated on the cover, a system of relays has been substituted for the meter. A low-grade egg trips one of the relays, lighting a lamp behind the letter C on the indicator board. A better egg trips two relays, lighting a lamp behind both C and B. A grade AA egg turns on all the lights.

The weighing equipment is mounted on the ring-stand. The egg's weight pushes the glass rod down against the tension of the coil spring, changing the position of the movable arm of a variable resistor and thereby varying the current supplied to the indicating de-

(Continued on page 61)

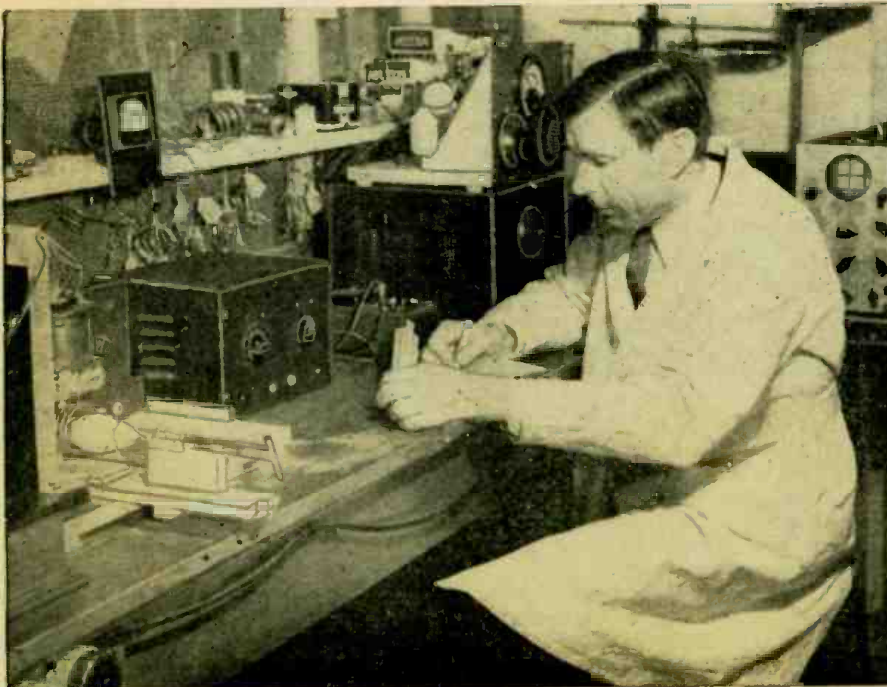

Dr. Romanoff records his findings on grading eggs by electronics. Fresh infertile eggs have a higher conductivity and lower dielectric constant than fresh fertile eggs.

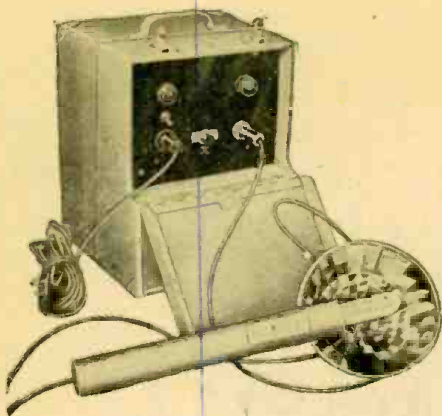

Flash gun and power pack complete the outfit.

Lightweight

Portable Photoflash

By W. G. MANY*



The equipment is light and easily maneuvered.

ELECTRONIC high-speed photoflash units are becoming increasingly popular as their advantages become more widely known.

In this article we give constructional data on a semi-portable photoflash outfit which is suited for any general indoor photo work along the lines of candid group shots, child portraiture, medical, scientific, technical, or sports subjects, where it is desired to stop fast moving or high-speed action. The equipment is easily constructed from standard components obtainable from most any radio parts supply distributor and consists of 2 principal units: a power supply and flash gun. The power supply unit and two 25 μ f, 2,000-volt photoflash storage capacitors are contained in a wood cabinet 9 $\frac{1}{4}$ inches x 10 $\frac{1}{2}$ inches

*Cornell-Dubilier Corp.

x 13 $\frac{1}{4}$ inches with a carrying handle and 15 feet of power line cord. It can be conveniently carried to any location within an average-size room in the home. The cabinet can either be made to suit the fancy of the constructor or may be one of many types of standard instrument cabinets.

A bakelite front panel 7 $\frac{1}{4}$ inches x 9 $\frac{13}{16}$ inches with a subbase provided mounting facilities for components shown in the photos and schematic diagram. The 115-volt a.c. pilot light, switch and plug receptacle are on the left side of the panel and the neon pilot and coaxial connector for the lead to the gun are on the right. A heavy-duty push-button switch is in the center of the panel. This shorts the storage capacitors through a 100-ohm, 100-watt resistor as a safety measure in the event the unit is removed from the cabinet or the high-voltage leads touched for any reason. As an additional safety precaution, it is well to get in the habit of pushing this switch immediately after the power-line switch is turned off. A slight snap of the discharge and the neon pilot going out indicates that the capacitors are properly discharged. Too much cau-

tion is not amiss on this score. It is also suggested to paint in large letters with red paint on both sides of the cabinet *Danger! High Voltage!* as a caution to those who may like to inspect things while the outfit is in operation.

The 2,200 volts a.c. from the special type photoflash transformer is rectified through a 2 X2/879 tube to charge the storage capacitors. The transformer also has a 2.75-volt, 1.75 ampere tap for the heater of the rectifier tube. A 100-ohm, 100-watt, wire-wound current-limiting resistor is mounted on the rear of the subpanel. A series of 6 carbon resistors, employed as a power supply bleeder, are mounted beneath the subpanel where connections are made to an inverted-can-type, 2- μ f, 2,000-volt capacitor. The rest of the layout and wiring of parts on the front and subpanels are shown in the accompanying photos and wiring diagram.

The pros and cons on circuits employing relays with open ended spiral self-ionizing tubes versus that of an auxiliary triggering circuit method using a closed spiral tube will not be discussed here. We decided to build this outfit em-

(Continued on page 52)

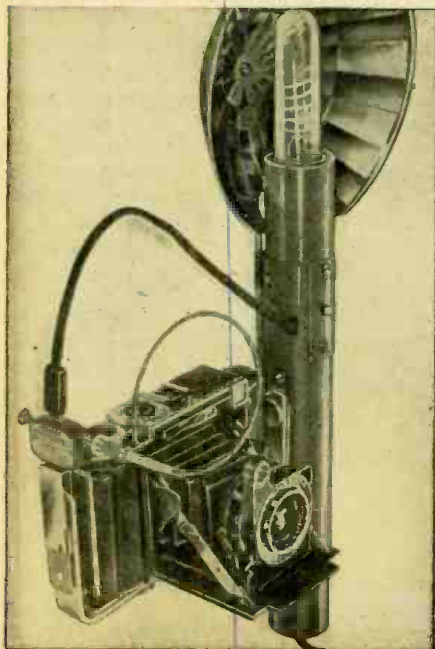

The gun portion mounted in place on a camera.

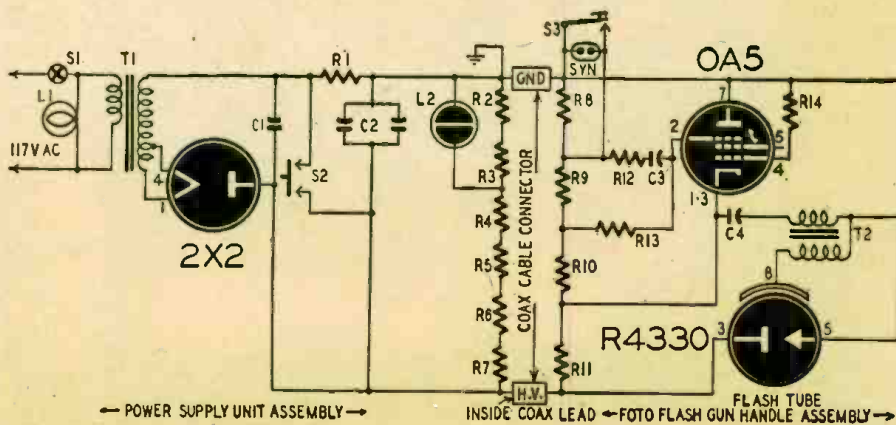
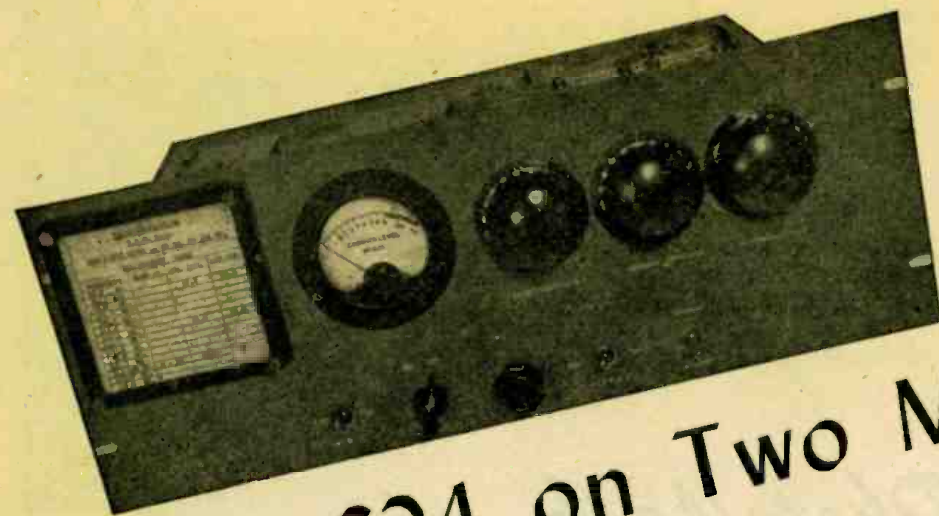

Fig. 1—Complete schematic of the power supply unit (left) and the trigger circuit (right).



◀ The S-Meter dresses up the panel.

BC-624 on Two Meters

By L. W. MAY, Jr., W5AJG

AMATEURS and experimenters who are looking for a good 2-meter receiver will be proud to own a BC-624-A. This is a really hot v.h.f. set covering from 100 to 156 mc. It is the companion unit to the BC-625 transmitter described in the April, 1947, issue of RADIO-CRAFT.

In its original form, the receiver has 4 preset channels that may be spotted anywhere within its tuning range. With minor mechanical and electrical changes, it can be tuned continuously throughout the entire band. Follow the partial schematic, Fig. 1, for the electrical changes. The layout of parts can be visualized from the photographs.

Three types of receivers can be used in the SCR-522. First is the BC-624-A, and the second is the BC-624-AM. This "M" stands for "modified" and means the original BC-624-A receiver has been improved. The modification consists of an additional tube under the chassis to serve as an automatic noise limiter and delayed a.v.c.

If this modification was made in the field, a stencilled "M" will be found near the Army nameplate. If it was made in the factory, the full designation will appear on the nameplate. There is absolutely no difference between the factory and field reconversion.

The third is the BC-624-C. This has several improvements over the BC-624-AM, the most important being an electronically-operated squelch system, in place of the mechanical relay system of the BC-624-A and BC-624-AM, and an extra audio stage. The r.f. sections of all three are identical, and all sets are interchangeable in the SCR-522 rack mounting.

Most of the sets available as surplus are BC-624-A's or BC-624-AM's. The schematic of the BC-624-A (Fig. 1) shows the changes made for amateur use at W5AJG.

The original tube line-up is as follows: 1 Type 9003 (VT-203) r.f. amplifier; 1 Type 9003 (VT-203) mixer; ½ 12AH7-GT (VT-207) crystal oscillator;

1 Type 9002 (VT-202) harmonic generator; 1 Type 9003 (VT-203) harmonic amplifier; 3 Type 12SG7 (VT-209) i.f. amplifier stages (12 mc); 1 Type 12C8 (VT-169) detector, a.v.c. and first audio; 1 Type 12J5-GT (VT-135) second audio amplifier; and ½ 12AH7-GT (VT-207) audio squelch tube.

Ten tubes are used in a high-quality circuit with four preset remote-controlled frequencies between 100 and 158 mc. To cover this range, the crystal-controlled oscillator uses crystals with fundamental frequencies between 8 mc and 8.7 mc. The harmonic generator (9002) then selects the proper harmonic of this frequency as the remote ratchet mechanism of the preset channels operates. Since this multiplication is from the eleventh to the eighteenth harmonics, depending upon frequency selected, the harmonic amplifier (9003) stage is used to reinforce the relatively weak harmonic signal to sufficient amplitude for injection to the 9003 mixer grid.

The harmonic generator and the harmonic amplifier have their variable capacitors ganged, and the control is brought out through the front panel. The other tuning control is a 3-gang capacitor that tunes the r.f. grid, r.f. plate, and mixer grid circuits. These capacitors are the butterfly type, and 90-degree rotation covers the minimum-to-maximum range. The tuning range of the receiver is rather crowded, so direct-drive dials cannot be used without some means of spreading out the tuning range of the receiver. Band spread is mandatory and may be accomplished either mechanically or electrically. The preset ratchet mechanism will be discarded, as we want variable tuning.

How to get band spread

If mechanical band spread is selected, a dial with a ratio of several hundred to one must be employed on the 2-gang capacitor section. Since only 90-degree

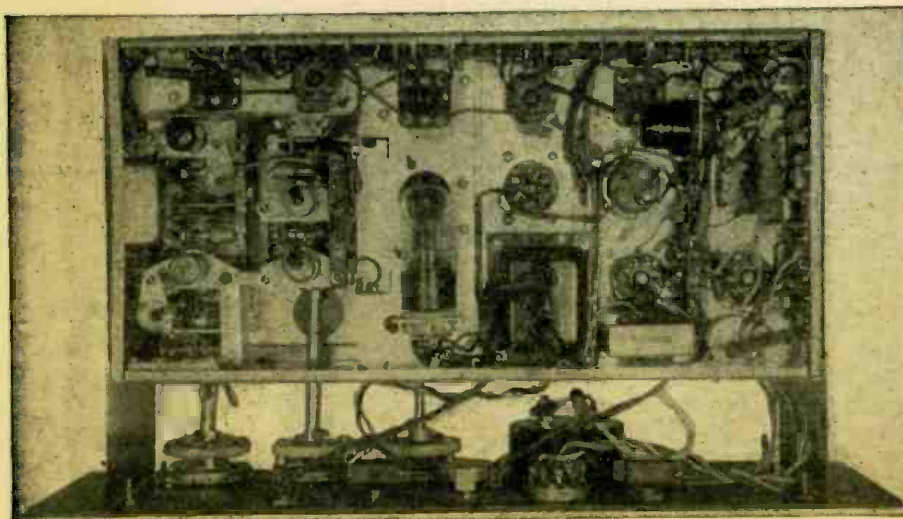

Fig. 2—Under side of chassis. Note the panel mounting and placement of tubes.

rotation is used, a 400-to-1 dial will provide approximately a 200-to-1 actual tuning ratio. This will spread the 144-148 mc ham band over about 1 inch of dial travel. One must be prepared to do a little juggling with loaded gears to prevent backlash. Dials of this type are available on the surplus market and are of the same type as used in the Army's receivers of the BC-348 class.

Electrical band spread was finally decided on at this station. A surplus 2-gang, 2-plate, insulated-shaft condenser was placed in parallel with the harmonic generator (which is to become the oscillator stage) and the harmonic amplifier stage (to be described later). This provides a full 100 degrees of band spread on the 144-mc band. In fact, band spread may be obtained anywhere along the spectrum covered by the receiver, which in its final form is from 88 to 158 mc. The main oscillator dial is then used only for band-setting, the band-spread dial being used for regular tuning. Ordinary inexpensive dials with a reduction ratio of only 3 or 4 to 1 are usable and serve nicely.

We now have 3 dials in a row; one the r.f. and mixer tuning, labeled ANTENNA TUNING; the second, which is the oscillator and amplifier tuning, labeled MAIN TUNING; and lastly the 2-plate 2-gang trimmer condenser, labeled BANDSPREAD TUNING. All of these dials are of the National Velvet vernier type from surplus BC-375-E Tuning units.

Further modifications

Other recommended changes in the BC-624-A include the addition of a power audio output stage, a series-valve automatic noise limiter, and an S meter, which can be adjusted to any value. You can therefore set your own standard of signal strength. Last but not least, a

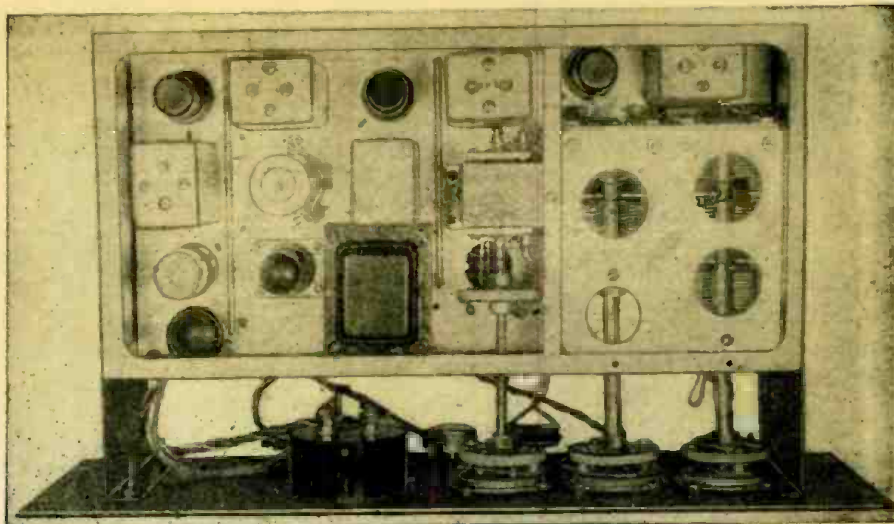

The top view presents a neat appearance. The power transformer is left of center.

built-in power supply operating from 117 volts a.c. makes the completed receiver something to be proud of in a v.h.f. job. Here is how the above is accomplished:

A 12H6 is mounted on a bracket under the receiver chassis. Should your receiver be a type BC-624-AM, this will already have been mounted. Refer to Fig. 2, which shows underside of the BC-624-A. One half of this 12H6 serves as the second detector, and the other half as the noise limiter. This tube replaces the original 12C8 tube. A 12AH7-GT is mounted in place of the 12C8 tube and serves as the first audio amplifier and S meter tube. A 12A6 power amplifier tube is then added to take care of the final audio requirements. This tube is placed where transformer 295 was mounted. Transformer 295 is not used and the squelch feature is also

eliminated, as no practical use could be found for it in amateur communications work. Naturally the crystal-controlled oscillator is not used. This releases the 12AH7-GT for the substitution mentioned above. Space is left which can be utilized to mount the bandspread condenser. The mechanical squelch relay and the crystal holder sockets are removed to make way for the power transformer.

A 6X5 rectifier and a midget output transformer—to match the 12A6 to a voice coil—are mounted on the underside of the chassis. Leads from the voice-coil winding go to a phone jack on the left side of the receiver. Only the filter choke in can No. 296 is used. The original filter condensers 212A and 212B are sufficient for filtering. All components

(Continued on page 62)

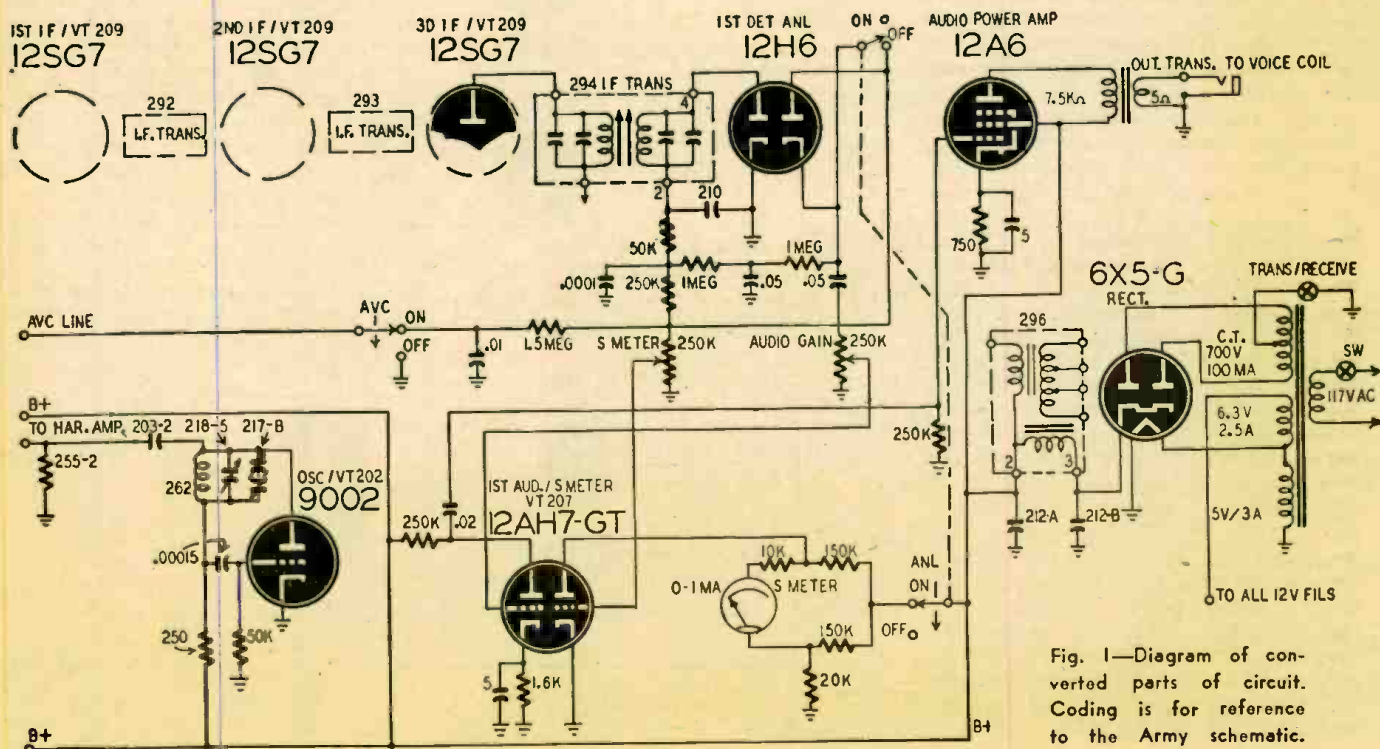
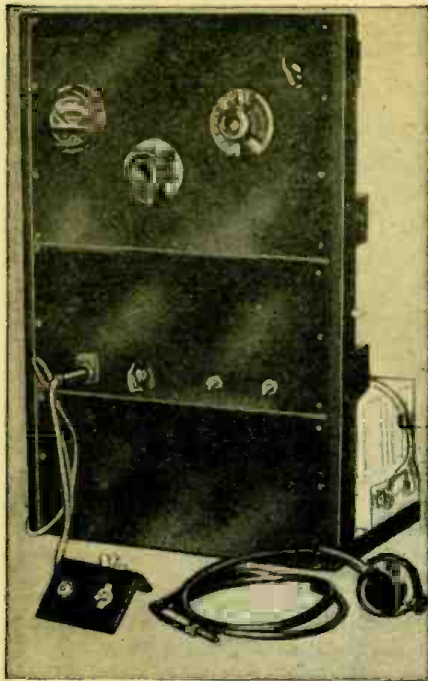

Fig. 1—Diagram of converted parts of circuit. Coding is for reference to the Army schematic.



The 24-inch rack fits the rear seat or in the luggage compartment of almost any car.

IN designing the mobile transmitter described here the following characteristics were required:

1. Low drain from the car battery;
2. No conspicuous knobs or panels on the dash;
3. Simple, reliable, and trouble-free operation;
4. Convenient size with no crowding of parts;
5. Separate units so that experiments could be carried on without dismantling the entire transmitter.

Except for the microphone and control panel, the transmitter is self-contained. It measures 20¼ inches high, 14 inches wide, and 9 inches deep. The control panel is 3½ inches wide and 2 inches high. With a little care it is possible to make a neat installation in any type of car.

After a few trials it was decided to use a pair of HK24's in the tuned-grid, tuned-plate, push-pull oscillator circuit of Fig. 1. Experience has shown that the choice was a good one. The oscillator is stable and unaffected by ordinary vibration. The tubes are rugged and operate well even on 300 volts. A 500-volt dynamotor was used for a short time with some increase of power, but not enough to offset the additional drain on the battery. The sockets for the HK24's are subpanel-mounted the depth of the tube bases so that the plate tuning condenser mounts on a level with the plate leads.

Both tuning condensers are split-stator, 100 µf per section. The plate condenser was not changed, but the grid tuning condenser was modified. All but two plates were removed from each section for band spread. Each tuning coil should be silver-plated and mounted directly on the corresponding condensers.

The two filament chokes are self-supporting, one end being soldered directly

Mobile Xmitter For Two Meters

◀ This push-pull tuned-plate tuned-grid oscillator is stable, even with plate modulation.

By ERNEST L. BYRD

to the filament contact and the other to a terminal strip. The plate choke is wound on a ceramic rod with heavy leads from each end. One of these is soldered directly to the mid-point of the tank coil, the other going through a hole in the chassis to a terminal strip. The antenna coil may be adjusted for best results and then left fixed in that position, unless the antenna itself is changed. It may be mounted on stand-off insulators.

The modulator circuit

The speech amplifier uses a 6J5, and the modulator is a 6N7 (Fig. 2). An aircraft-type hand microphone is used, current being obtained through a resistor from the battery. S-1 is a test key in parallel with the microphone push-to-

talk switch. S-2 is a safety switch which makes it impossible to put the transmitter on the air from the control panel. This feature will be appreciated by anyone having small children who like to play with cute little gadgets.

The power supply is bolted directly to the bottom of the rack for two reasons: first, because of its weight and, second, to secure a good ground connection. A good ground is provided by bolting one end of a length of heavy metal braid between power supply and rack, and the other end to a good ground on the frame of the car. The power supply is a Mallory-type VP555 which has an output of 200 ma at 300 volts. Fig. 3 shows the equipment's physical layout.

Tuning is simple. A neon bulb is held (Continued on page 58)

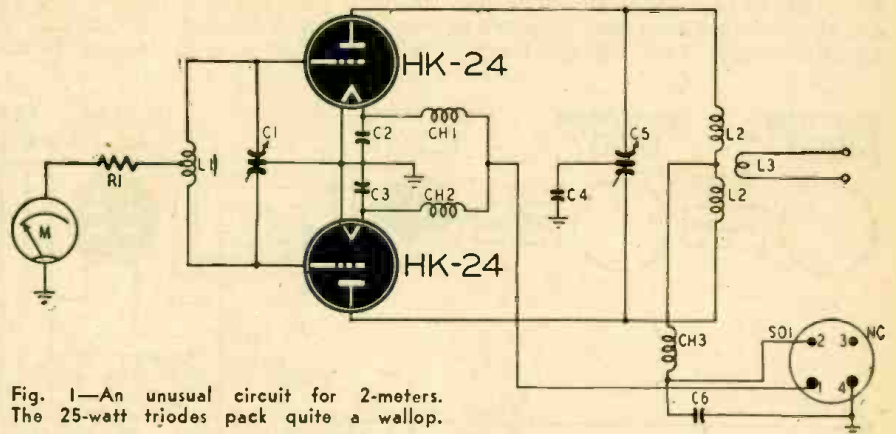

Fig. 1—An unusual circuit for 2-meters. The 25-watt triodes pack quite a wallop.

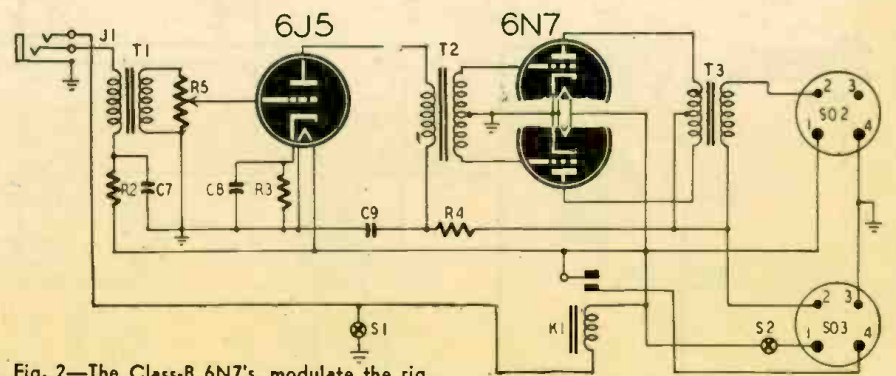

Fig. 2—The Class-B 6N7's, modulate the rig.

Low-Priced FM Tuning Unit →



The new Pilotuner Model T-601 FM tuning unit. The former makes it practical and safe to connect the tuner to a.c.-d.c. equipment regardless of power-line polarity.

THIS new FM tuner Model T-601 manufactured by Pilot Radio should go far to change the character of FM listening audiences by taking FM out of the luxury class and making it available to the average man. All of this is done with a 5-tube superheterodyne FM tuner or adaptor—The Pilotuner—retailing for *only* \$29.95—probably the lowest priced tuner in the history of FM. It is easy to attach to any standard radio, phonograph, or amplifier system. Connect it to the audio amplifier or phono input jack of any radio and the set becomes a complete FM-AM radio for the 88- to 108-mc band with all advantages of far more costly sets. Prewar FM sets can be modernized to tune in the new bands by connecting the tuner to the audio system instead of making complicated and costly conversions.

The unit is compact. It has a walnut-finished cabinet only 8 3/4 inches wide by 6 3/4 inches high by 5 1/4 inches deep that will fit conveniently on top of the average radio, phonograph, or table. It has an attractive dial calibrated directly in megacycles and in channel numbers.

External antennas are not required in areas where signal strength is high, because the set has a built-in nondirectional antenna that can be used where outdoor antennas are not practical or permissible.

The tuner is a.c.-operated with a rather unusual power supply consuming 35 watts. An isolating transformer, with filament and 110-volt plate supply windings, and a selenium rectifier are used. This minimizes shock hazard, conserves space, and reduces heat radiated from the power supply. The trans-

The circuit

The set uses 5 miniature tubes and a selenium rectifier. The tubes used are: 6BA6 r.f. amplifier, 6BE6 mixer-oscillator, two 6BA6's as i. f. amplifiers, and a 6AL5 ratio detector. The r.f. coil does not have a primary winding. It is tapped above the ground to provide a match for a 300-ohm, unbalanced transmission line from an outdoor antenna. The r.f. amplifier is impedance-coupled to the mixer tube. The grids of these tubes are tapped down on their respective coils to reduce circuit loading and preserve high-Q tuning elements.

The coils in the front end are wound
(Continued on page 65)

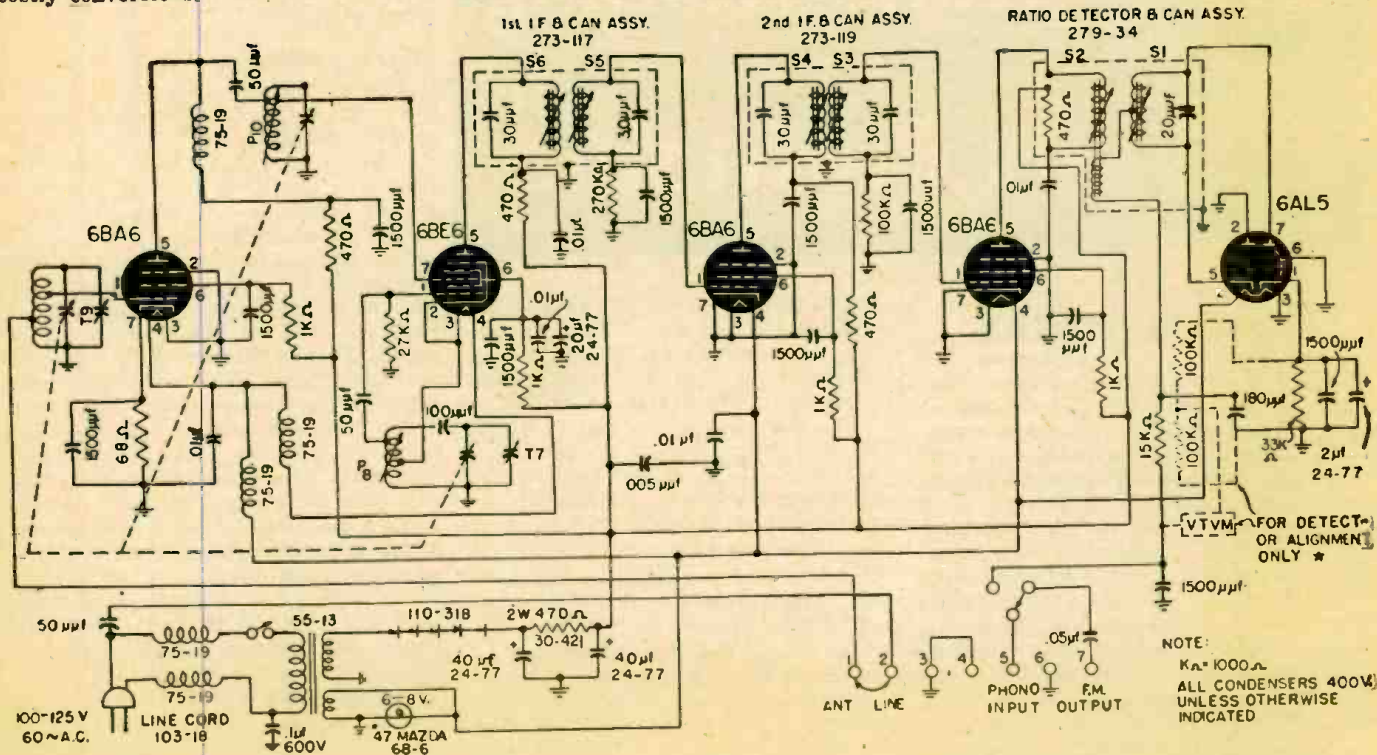

- S₁ RATIO DETECTOR SEC. 10.7 MC.
- S₂ RATIO DETECTOR PRI. 10.7 MC.
- S₃ 2ND I.F. SEC. 10.7 MC.
- S₄ 2ND I.F. PRI. 10.7 MC.
- S₅ 1ST I.F. SEC. 10.7 MC.
- S₆ 1ST I.F. PRI. 10.7 MC.
- T₇ OSC. TRIMMER 106 MC.
- P₈ OSC. PADDER 90 MC.
- T₉ ANT. TRIMMER 106 MC.
- P₁₀ R.F. PADDER 90 MC.

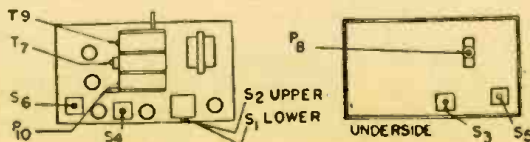

TO ALIGN RECEIVER USE FREQUENCIES AS INDICATED ON LEFT. ADJUST ALL TRIMMERS FOR MAX. D.C. OUTPUT ACROSS 33KΩ RESISTOR IN 6AL5 CIRCUIT
* TO ALIGN SECONDARY OF RATIO DETECTOR CONNECT METER AS INDICATED IN SCHEMATIC AND ADJUST S₁ FOR ZERO OUTPUT.

Interference can be made into a source of good business by a wide-awake service technician

Getting Poor Radio Reception?

Fallon Standard Launches Community Campaign to Eliminate Interference

By arrangement with city officials and Slum's Radio Shop, Fallon Standard has launched a radio interference elimination campaign in Fallon. Designed to clear up venalious sources of static and other disturbances, the plan, to be successful, calls for real cooperation on the part of the people of the community. If you are troubled with radio interference, call the office of Fallon Standard at 124 W. and we will send an expert trouble-shooter to your home. He will bring instruments designed to detect the source of the trouble in your neighborhood and when it is located will seek to correct the trouble by installing condensers on wastepipe pipes of electrical equipment causing the disturbance.

Another way in which you can co-

operate is to make certain that none of the electrical appliances in your home are causing neighborhood disturbance. The elimination of disturbance is easy, the main thing is to locate it. If you are in doubt about your own appliances call us.

Some of the principal causes of radio disturbances are:

1. Electrical appliances in the neighborhood.
2. Wet tree branches in contact with power lines.
3. Loose connections.

Not generally known is the fact that an electric shaver with out the proper static eliminators can cause radio interference up to a quarter of a mile. Vacuum cleaners, toasters, mixers, hairdryers and other appliances may also be causing you or your neighbors to have poor reception.

Co-operate by letting us know if you are having such troubles. You can also get prompt action by calling city engineer Herb Latin.

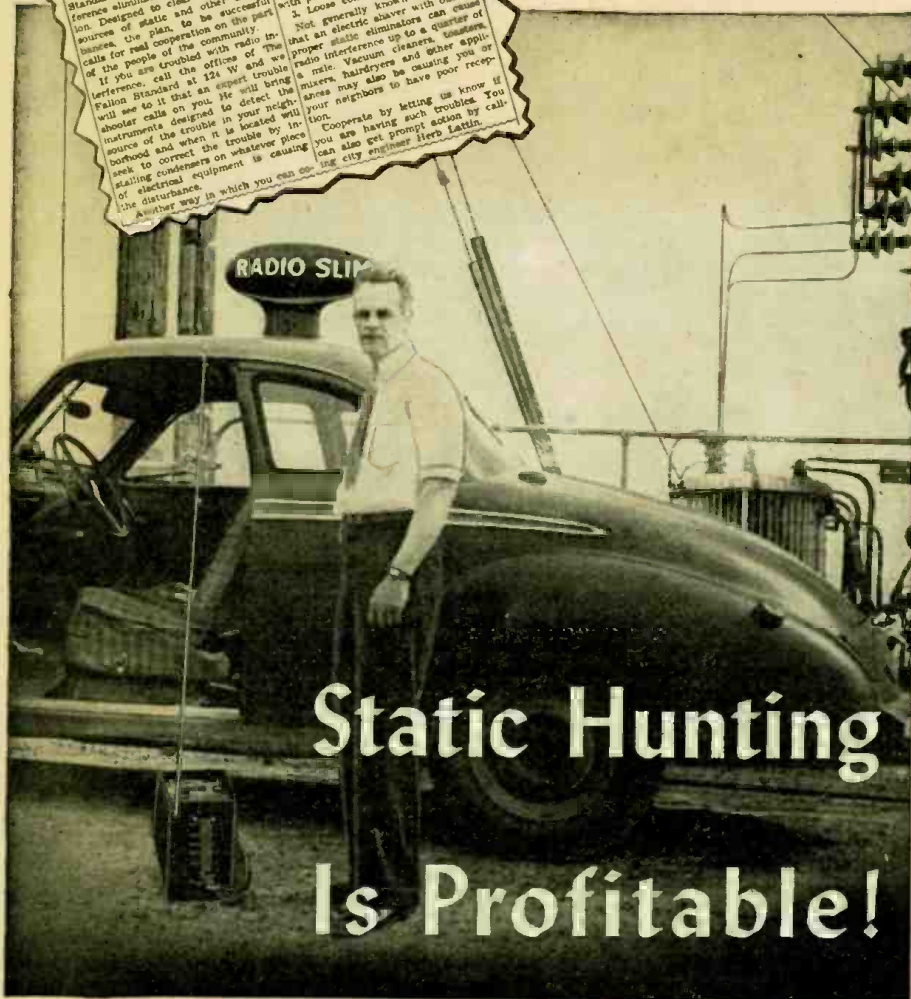

Static Hunting Is Profitable!

By PAUL W. STREETER

RADIO interference always has been the bugaboo of good reception, especially in small towns distant from powerful stations. Yet most radio repair shops studiously avoid having anything to do with it.

It has been found that the location and cure of radio interference caused by electrical equipment can mean much more service work for the average radio shop. Some government surplus radio equipment now available has simplified the isolation of radio interference by making it much easier to track down and cure troubles of this nature.

The writer has been actively engaged for several years in spotting radio interference. The equipment used has been modified repeatedly. In its present form, it is simple and inexpensive to obtain as well as easy to use. With it, most radio "racket" can be tracked down in a matter of minutes.

There are several *MUSTS* that should be observed if any noise reducing campaign is to be successful. First, the local power company has to be willing to co-operate in every attempt to reduce interference caused by leaky insulators, poor connections, loose fuses and other troubles on their high-voltage lines. Generally it will welcome any information since it is dollars and cents saved to correct all power leaks.

Practically all power leaks that cause radio interference are found to originate on the primary distribution system. In most localities this consists of 3-phase, 4,100- or 2,400- volt, alternating-current supply to transformers mounted on the utility company's poles and which step it down to the 120 or 240 volts supplied to consumers. Since these high-voltage lines are on the generating end of the power company setup, any leaks that develop are on the *line* side of the consumers' meters and therefore mean money out of the power company's pocket.

When power leaks are found to be the cause of radio interference, the source is located and the power company is notified. Even 110 or 220 volts can be fatal. **NO ATTEMPT SHOULD BE MADE BY THE RADIO MAN TO CURE THE TROUBLE.** In every case it should be called to the attention of the power company, to be taken care of by its own linemen. High voltages, with the whole power plant behind them, are not to be handled by anyone not qualified to do so and not having the proper tools and safeguards. No matter how much the radioman knows about radio, he cannot work with high voltage. If notified, the power company will be glad to send linemen out to cure the trouble. The writer has an arrangement with the local power company whereby it sends a crew out immediately. The co-operative spirit is mutual, for the author's equipment is available for the crew members to use to locate and cure the defect. They appreciate that.

Not essential, but a help, is a study of the local city and county ordinances dealing with radio interference. Most communities have specific ordinances covering interference created by electrical equipment.

Start a campaign

Another "*MUST*" is proper publicity. *There is not a radio repair shop in the country which cannot use it.* The increase in business due to personal contacts and local publicity is amazing. Proper publicity can be easily taken care of. The leading local paper should be contacted. The editors will jump at the chance to sponsor a local interference campaign, inviting readers to report all cases of interference to the paper. These calls are turned over to the radio shop. No charge is made either to the paper or the complainant.

The writer's experience has been that free publicity tying in the radio shop with the interference campaign paid off in a big way. Tube sales doubled in 10 days' time. Repair jobs increased about 40%. By continual contacts the campaign has been kept alive. The paper periodically prints items on noise that has been found and cured, and invites additional complaints.

The necessary equipment

Free publicity by itself won't *CURE* the noise complaints, of course. Results have to be obtained. A portable tuned-radio-frequency receiver using low-drain tubes should be built. The receiver should consist of 2 r.f. stages, a detector, and audio amplifier, with provisions for both a whip and loop antenna and an output meter across the speaker

voice coil. A switch to cut the meter in and out should be provided. Batteries should be self-contained and suitable switching arrangements to use either antenna incorporated. The one used by the author is shown in the diagram and photographs.

In addition, the radio in the service car should be modified as follows: The a.v.c. should be removed by means of a switch and resistor, to ground the diode circuit. A suitable output meter should be installed below the windshield and connected across the speaker voice coil. A dimly lit dial lamp for this meter is a necessity. The antenna coil should be removed and an additional primary winding of 20 turns of No 34 d.c.c. wire wound on it to make it possible to connect an aircraft radio compass loop antenna. This loop can be purchased from government surplus equipment now available. The one used here is an Army Air Forces type LP-21A loop antenna formerly used on an Army bomber. It was bought for \$3.50. It was disassembled and the aluminum band around the outside of the loop winding discarded. The loop rotating shaft was lengthened 6 inches so that it would extend into the car. The rotating motor and Autosyn were discarded. The grounded center tap on the loop winding was removed, and the loop reassembled and painted. It was mounted on the car, and a low-loss, 2-wire shielded lead was run from the loop to a control switch on the dash and thence to the radio. The auto radio whip aerial was also connected through a switch to the set. All leads and switches were suitably shielded. In this manner either aerial can be used at will. Separate switches and shields were used to prevent interaction.

To calibrate the loop, tune in a station the direction of which is known and turn the loop to the null or minimum pickup position. Attach the pointer knob to the end of the shaft inside the car, so that it points to the station. This position is critical, the angle being only 1 or 2 degrees of rotation. The loop is bi-directional and will give a null reading with the knob pointing to or away from the station. In use, the loop is turned to the interference

null and the direction noted. Another similar reading is taken some distance away. Where the two readings intersect will be the source of the noise. This method is used with the portable receiver in cases where it is impractical to take the car.

Home-made interference

To use the equipment, it is necessary only to drive to the complainant's home, introduce yourself, and listen to the racket on his radio. About 3 out of 5 calls ended in business for the repairman right there! The number of radios which created their own "interference" was startling. In the majority of cases, hum from bad tubes and filter condensers was easily cured by the usual remedies. Other cases included loose aerial and ground connections, loose house fuses, etc.

Where it is found that the interference is outside the radio installation, systematic steps to locate the noise should be taken. First, the portable should be turned on and the noise picked up. The house wiring should be traced and appliances tested for noise. Motor noise generally will be found to be in the same building or in the immediate neighborhood. In practically all cases, motor noise will be confined to circuits connected to the same transformer, since this type of interference is not generally fed back into the pri-



The output meter for the motor-car receiver.

mary distribution system. Motor noise can be cured with suitable filters obtainable at most radio parts houses. This writer installs them at cost. Motor owners are grateful, to say the least.

Fluorescent reading and bed lamps create a terrible din. They can be quieted in some cases with filters especially designed for this equipment. Some however, have vibrators, and this writer has yet to see a filter that will completely eliminate the interference they create.

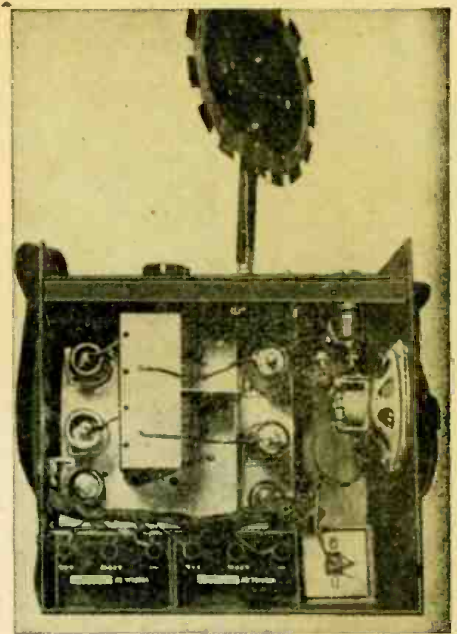

Rear view of the portable trouble hunter.

In such cases the lamp's owner is asked to co-operate. Only one case was found where co-operation was not forthcoming and that was taken care of by publicity in the local paper.

Power-line troubles

Power-line noise was found to fall into 4 general classes. Since most radios are operated in residential areas, trees growing into the high-voltage wires cause trouble. The power companies are continually trimming trees. The noise is a very distinctive, low-pitched type, most noticeable on windy days. Close inspection of the high-voltage wires should disclose the location. In every case the wires will have withered and burned the tree leaves and scorched the bark. Here the portable with the whip antenna comes in handy. Volume will build up tremendously within 100 feet of the source.

The power company's pole transformers usually cause no trouble, but the high-voltage leads and fuses often develop loose connections. The resultant arc causes radio interference over a

(Continued on page 64)

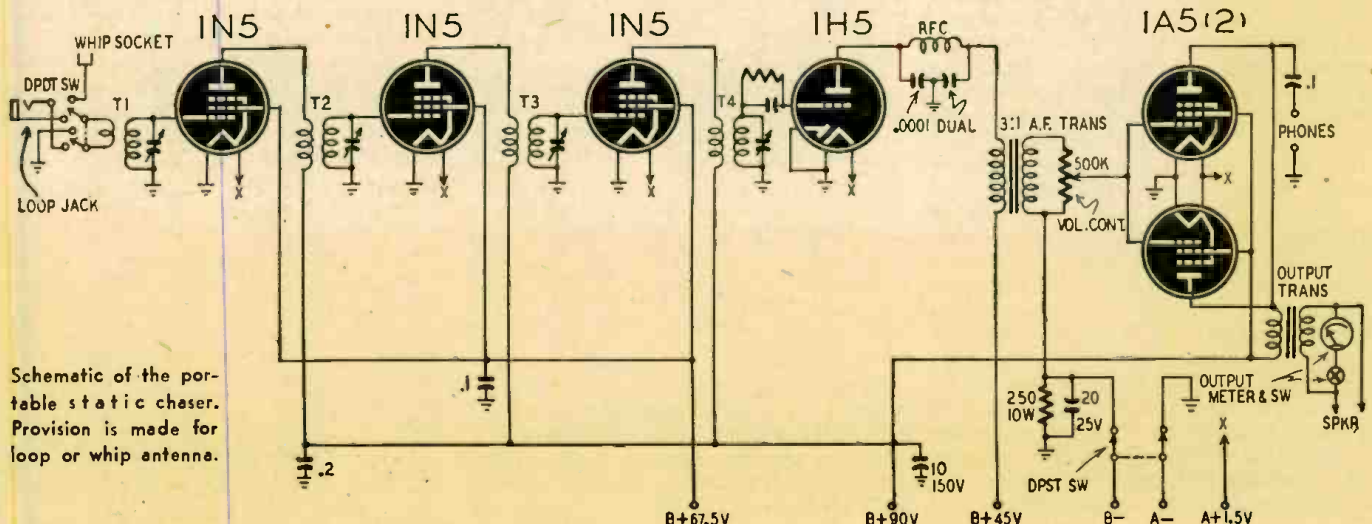

Schematic of the portable static chaser. Provision is made for loop or whip antenna.

250-Watt FM-AM Transmitter

PART III—How the FM circuits are aligned

By HARRY D. HOOTON, W3KPX

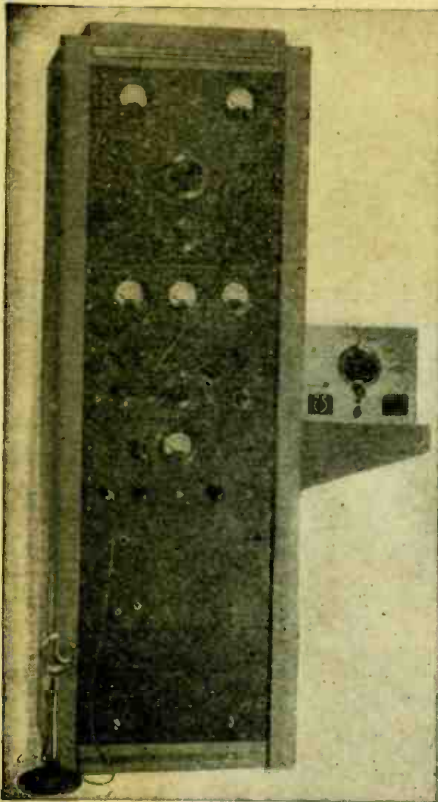

The complete transmitter plus v.f.o. unit.

TO PLACE the FM circuits in operation, remove the plate and screen voltages from the TB-35 and the plate voltage from the HK-54 tubes. Also for the preliminary adjustment, remove the lead between the 500,000-ohm resistor and the FM deviation meter jack; ground the free end of the 500,000-ohm resistor. This removes the stabilization voltage from the FM oscillator and permits closer checking of this circuit.

If an audio-frequency oscillator or a record player is available, feed the a.f. signal to the crystal microphone jack and keep the deviation control turned down. Place the 7,000-kc crystal in its socket and plug a pair of headphones into the monitoring jack. Turn up the deviation control slightly, and simultaneously rotate the 6F6-G grid and plate tank tuning capacitors until the sound is heard in the headphones. Peak the signal for maximum volume by adjustment of the 6F6-G plate tank tuning capacitor and the primary trimmer of the discriminator transformer.

At this point check the frequency of the FM oscillator. Turn off the deviation control. Using a regular communications receiver, equipped with a beat-frequency oscillator, tune in the oscillator carrier. With a 7,000-kc crystal oscillator and a 350-kc discriminator transformer, the receiver must be tuned to around 7,350 kc. *Make certain that the oscillator frequency, when quadrupled, will fall within the limits of the 10-meter FM band.*

The discriminator output circuit may

be zeroed by the "adjust and try" method of alignment. However, if the constructor can beg, borrow, or steal a vacuum-tube voltmeter or a conventional d.c. voltmeter having a scale of 0-10 volts and an internal resistance of 20,000 ohms per volt or higher, a more satisfactory alignment job can be done. To align the discriminator by the voltmeter method, first connect the meter to the FM deviation meter jack and detune the secondary trimmer of the discriminator transformer slightly. Now, adjust the 6F6-G plate tank tuning capacitor and the primary trimmer of the discriminator transformer for *maximum* output indication on the voltmeter. After these circuits have been adjusted for maximum voltage indication, adjust the discriminator-transformer secondary trimmer for *zero or minimum* voltage indication. The zero adjustment is very critical and the voltage output changes polarity as the circuit passes through resonance. Adjust the trimmer as accurately as possible for zero-voltage indication.

Generally, the adjustments can be carried out as described and then left alone. The progressive amateur, however, will want to check his adjustments to make certain they are correct. For best FM results, the discriminator output should be linear with respect to frequency deviation each side of the unmodulated or center frequency. To check the linearity, swing the 6F6-G oscillator frequency approximately 25 kc *higher* than the unmodulated carrier frequency and note the voltmeter reading. Now, swing the 6F6-G oscillator frequency approximately 25 kc *lower* than the unmodulated carrier frequency and again note the voltmeter reading. The two voltmeter readings should be approximately equal in amplitude but opposite in polarity.

If the two readings are *not* equal, the discriminator primary trimmer may be readjusted slightly. It will be necessary to readjust the zero setting of the secondary trimmer as there is some interaction between the two adjustments. The primary trimmer controls the amplitude and linearity of the discriminator output; the secondary trimmer controls the placement of the zero-voltage point on the voltage-frequency characteristic curve.

Now, disconnect the 500,000-ohm resistor from ground and reconnect it to the FM deviation meter jack. Using a regular communications receiver, equipped with a b.f.o., tune in the FM oscillator carrier. Now, change the os-

illator frequency slightly and follow the signal with the receiver. If the discriminator output voltage is of the proper polarity, a frequency will be found where the oscillator suddenly locks in and the 6F6-G grid tuning capacitor will have but little effect on the frequency over several degrees on the tuning scale. This indicates that the stabilizing circuit is operating properly and is returning the oscillator frequency toward its center or unmodulated carrier frequency.

If the opposite effect results and the stabilizing circuit causes the FM oscillator to jump from one frequency to another when the 6F6-G grid tank tuning capacitor is varied, the discriminator output voltage is of the wrong polarity for stabilization. The remedy is to reverse the connections from the discriminator-transformer secondary winding to the plates of the 6H6 tube.

The stabilizing circuit may be checked for operation by removing the crystal from its socket and bringing the hand near the 6F6-G oscillator grid coil. With the crystal out of the circuit, the frequency should vary greatly when the hand approaches the grid coil; with the crystal in its socket and the stabilizer circuit operating properly, only a very slight frequency variation should take place when the hand is brought close to the coil.

Check your frequency!

Always check the output frequency of the transmitter before placing it on the air. When operating on FM, keep the deviation control turned down. It is a good idea to place the transmitter on a dummy antenna and practice transmitting before the FM signal is actually placed on the air. The signal can be heard on a regular communications receiver *if the frequency deviation at the transmitter is kept low.* The only noticeable difference between the narrow-band FM signal and the regular AM signal is in the tuning of the communications receiver. The FM signal is received on the slope of the receiver i.f. response curve and therefore the receiver will tune through 2 signal peaks. This inherent characteristic is actually an advantage in itself; one signal peak may be covered with interference and the operator may then tune to the second peak which is free from interference.

The deviation should be limited to a swing of about 3 or 4 kilocycles each

(Continued on page 73)

SIGNAL TRACER-INJECTOR FOR EFFICIENT SERVICING

By LYLE C. TREAKLE

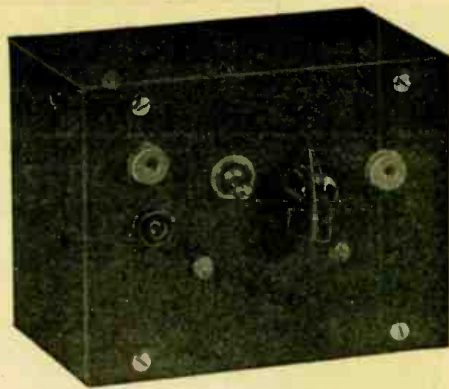

SIGNAL INJECTION as a means of localizing troubles encountered in radio receivers is used with much success by many fast-working repairmen. Usually a conventional signal generator is used, and the output is applied to each stage, beginning with the power amplifier and working back. The disadvantage of this system is the time that must be taken to make adjustments on the signal generator to change the frequency as the different stages are checked.

Signal tracing as a service technique has been very popular for the last few years. There is still much room for improvement in this system, and in some cases signal tracing is a slow procedure compared to other methods of servicing.

The test unit to be described is an extremely simple yet versatile instrument. It supplies all the needs of a signal tracer or a signal injector. When used as signal injector, it aids the repairman in rapidly locating the defective stage of a receiver. It has only one control, the output attenuator.

Signal injection is by no means a system which can be used on all types of service jobs. It is used to particular advantage on dead receivers or receivers which have extremely low sensitivity, and it also can be useful on cutout cases.

The circuit of the test unit is shown in Fig. 1. It is a simple multivibrator and a 1-stage amplifier with switch in position shown; the fundamental frequency of the multivibrator is approximately 3,000 cycles. Since the output of a multivibrator has a very distorted wave form which approaches a square wave, it must contain a large number

of harmonics. When the output of the unit is applied to the antenna post of a receiver, a harmonic of the signal from the signal injector can be picked up at almost any point on the dial; one of the harmonics being present every 3 kilocycles. If the wave were perfectly square, it would contain only the odd-order harmonics. As the receiver selectivity is 10 kilocycles, these would be receivable at any dial setting. Harmonics as high as 18 megacycles have been picked up from the multivibrator on the unit built by the author.

Also a signal tracer

When the switch is thrown to the opposite position, the 2 triode tubes are connected as a conventional 2-stage, resistance-coupled amplifier. The 32L7 is the power amplifier and rectifier tube. The design is of the a.c.-d.c. variety, to keep construction costs to a minimum. The entire signal tracer-signal injector is built into a standard 4 x 6-inch metal cabinet. The front-panel controls include the changeover switch and the attenuator, to which the a.c. switch is attached.

A speaker was not included within the instrument built by the author; however, the cabinet will permit inclusion of a 3-inch PM speaker if desired. By connecting the voice-coil leads to the pin jacks, connection can be made to the speaker voice coil of the receiver under test or a bench speaker may be used; or a pair of phones may be connected to the voice coil jacks if desired. The mismatch is great when the latter system is used but due to the high gain of the unit when used as an amplifier, sufficient volume is available.

How to use the unit

Using the unit as a signal injector will aid in the rapid location of the defective stage of a dead or low-sensitivity receiver. First apply the probe of the signal injector to the grid of the power tube and note the signal in the speaker. If it is normal, apply probe to the grid of the first audio amplifier tube. Then work backward, until the defective stage is discovered by the signal failing to pass through that particular stage, or the volume being reduced as compared to the signal obtained from the last stage checked. When checking the r.f. or i.f. stages, it is not always necessary to connect the probe directly to the grid of the tube. Usually it will suffice to hold the probe near any part of the grid circuit.

The attenuator on the test unit should be adjusted to the lowest level at which it is possible to receive an audible signal in the speaker. Errors due to the radiation from the probe being picked up by a succeeding stage and passed on to the speaker—leading the user to believe the signal has passed through the stage being checked—can thus be avoided. Should the receiver fail to operate on the regular stations, although the signal from the test unit can be heard in the speaker when the probe is connected to its antenna terminal, check the oscillator for operation at the proper frequency.

Stalking the intermittent

Intermittent or cutout cases, long a bugaboo to the radio repairman, can be simplified somewhat by use of the signal injector. When the receiver cuts out and some piece of test equipment is applied to its circuits, the shock from the test will often cause it to resume normal operation. When the signal injection method is used, the receiver is put in operation and the signal induced into its various stages to reveal to the operator the approximate volume level obtained from each point. In the r.f. and i.f. stages, the probe should not be connected directly to the grids but placed near some convenient component of the grid circuit, causing a small capacitance-coupling effect. Thus shock to the circuit can be kept at a minimum.

Now, assuming the set has been operating and has just cut out, bring the lead from the signal injector close to
(Continued on page 60)

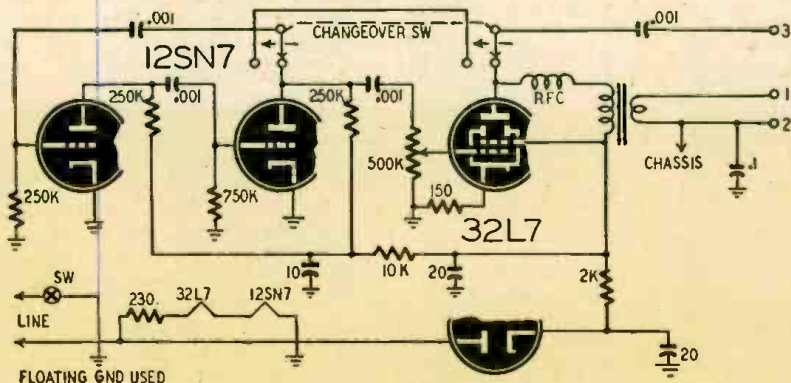

Fig. 1—A simple switch converts the unit from signal generator to tracer.



AUDIO OSCILLATOR WITH BAND SPREAD

PART II—Constructing the oscillator

By C. F. VAN L. WEILAND

THE theoretical design and operation of this audio-frequency generator was discussed last month. It uses eleven 2-to-1 tuning ranges to cover from 12.5 to 24,000 cycles. The circuit is a Wien bridge oscillator with a stage of amplification added. Its tuning differs from conventional methods in that the base frequency is selected with a range switch and the desired frequency selected with a continuously variable multiplier calibrated in small steps from 1 to 2.

The circuit, Fig. 1, was used in construction of this model. Frequency is controlled by the selective network R1-C1 and R2-C2. Amplitude of oscillations is controlled by a negative feedback through R3, L1, and L2. The power supply is conventional and delivers 250 volts at its terminals with a 14-ma load.

The oscillator-amplifier and the power supply are in a cabinet, 14 x 8 x 8 inches. The power supply is on a 7 x 2½ x 3¼-inch chassis. The oscillator and amplifier are constructed on a 9 x 7 x 2-inch chassis with an aluminum baffle underneath to isolate the tuning elements from the amplifier-oscillator stages.

The resistance tuning elements are in a standard 3 x 4 x 5-inch steel box with 4 x 5-inch covers on front and back.

Two dual potentiometers are mounted on one cover with their shafts protruding from the front. These are Clarostat linear, wire-wound units, 25,000 ohms to each section. They have a short end of the shaft protruding through the rear and it is natural that the author attempted to couple the shafts of the 2 potentiometers directly. Connections between the potentiometer arms of either unit are not strong enough to carry the torsional stress, thus causing excessive backlash and making proper tuning impossible.

Their shafts are connected through gears which may be seen in the photograph. Gears and potentiometers are available at surplus outlets. The gears used are slightly larger than the diameter of the potentiometers. Use of gears permits better tracking, as one of them may be advanced 2 or 3 teeth if required. This is permissible because the full arc of the control is not used since there is a small area at each end of the control where the resistance does not vary linearly with rotation of the arm.

An extension shaft is added to one of the units so that it protrudes through the front panel for direct connection to the dial knob and pointer. It is so located that the shaft extends through

the panel some distance above the center to permit the mounting of a calibrated scale on the range switch. After the potentiometers are mounted, four 20,000-ohm, ½-watt, metalized resistors and four 5,000-ohm, carbon potentiometers,

with slotted shafts, are connected in series with one side of the 25,000-ohm potentiometers as shown in Figs. 1 and 2. Settings of the 5,000-ohm units and gears are adjusted so the resistance between the 25,000-ohm and 5,000-ohm potentiometers will exactly double when the dial is rotated from minimum to maximum in a counterclockwise direction. For good performance, the resistance values and variations of all potentiometers should be exactly alike for perfect tracking.

After the resistor tuning unit has been assembled and spotted on the chassis, drill three ¼-inch holes about 1 inch apart on both sides of the resistor-switching sections of the range switch. These holes are drilled through the bottom of the resistor housing and the top of the chassis. They are spaced to reduce capacity between leads running from the potentiometers to the switch.

Values of resistance and capacitance for each range of frequencies are shown in Table I. The capacitances are used for C1 and C2, and the resistances are the values of R1 and R2 with the multiplier set for maximum resistance for the given settings of the range switch.

TABLE I

Microfarads C1 & C2 (Calculated)	Frequency — Cycles/Second		
	R1 & R2-A (Series)	R1 & R2-B (Single)	R1 & R2-C (Parallel)
0.134	12.5- 25	25- 50	50 - 100
0.168	100- 200	200- 400	400 - 800
0.0021	500-1600	1600- 3200	3200 - 6400
0.00056	Not used	6000-12000	12000-24000

The capacitors C1 and C2 for the 12.5 to 100-cycle ranges are made from a 0.1µf condenser paralleled with a 0.02-µf unit. It may be necessary to use a small padder to equalize C1 or C2. The condensers for these ranges must be selected and matched by cut-and-try until proper tuning is achieved as there is no variable padder of sufficient capacitance to be used here. The 0.0168-µf condensers are made from a 0.01-µf paper, a 0.006-µf mica, and a 1,000-µf (0.001) variable padder wired in paral-

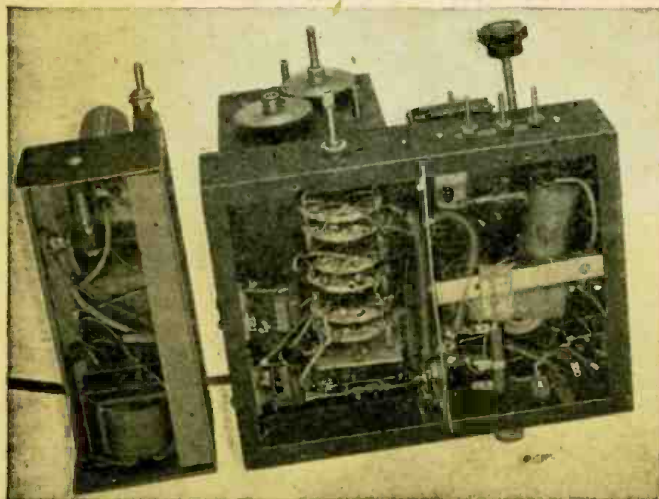

The undersides of the oscillator-amplifier and power supply. A shield divides the large chassis into two sections to isolate the tuning unit.

lel. The 800-6400 ranges require 0.0021 μf and consists of 0.0015 μf with a 750- μf variable padder. The last 2 ranges use 0.00024- μf micas with 0.000275- μf padders. The stray wiring capacitance makes up the balance of the required capacitance.

The condensers are on mounting strips above the chassis so that adjustments can be made from the top, or from the side as in the author's model. The entire assembly fits in a 3 x 4 x 5-inch shield can that has one side cut off. When finished, the can should fit snugly over 2 angle-iron strips which permit it to be removed for access to the condensers.

Condensers are balanced

It is important that the condensers of the first 2 stages be *exactly equal*. These may be balanced on a capacitance bridge or by connecting each set in series with the a.c.-range of a multimeter and the 117-volt a.c. line and noting the deflection. The deflections should be as nearly equal as possible to keep down distortion.

Measurements are not required for the last 2 sets of condensers as there is sufficient leeway in the padders for equalization. Slots are cut in the chassis near the condenser-switching sections of the range switch so that the wiring can be short and well spaced to reduce wiring capacity.

The range-selector is a standard 6-

pole, 12-position, shorting-type switch small enough to mount below the 2-inch chassis. A shorting-type switch is used to prevent the oscillator from falling out of oscillation when switching ranges. The soldering contacts should be bent at right angles to the wafers. If the end stop is removed, it is not necessary to go through 11 steps when going from the highest to the lowest range. The switch should have a rear mounting bracket to prevent it from twisting as it is turned. If a bracket is not available, one can be made from sheet metal. Tinned wire, covered with spaghetti, is used for the wiring on the switch. When long leads are required, low-capacitance, shielded cable should be used. A good grade of low-capacity microphone cable or flexible co-ax will work well.

Oscillator-amplifier

The 6SJ7-6J5 oscillator, 6SN7 amplifier, and all other components occupy the remaining half of the 7 x 9-inch

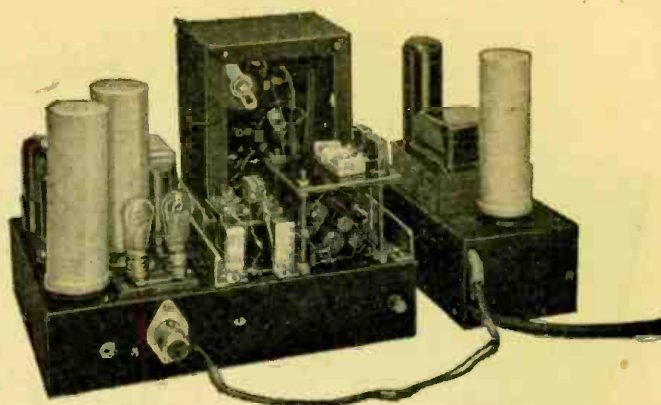

Rear view. The equipment is made in two parts, power supply and the oscillator proper. Note the night-lamp resistors on main chassis.

chassis. Only the wires to the grid of the 6SJ7 and from the feedback circuit pass through the shield under the chassis. The circuit is conventional with parts located as shown in the photographs.

Some points should be considered in constructing the unit. Condenser C4 must be of low impedance at low frequencies if it is not to disturb the feedback control in the low-frequency ranges. This condenser, as well as C7 and C8, were insulated from the chassis, to reduce possible capacity to ground.

The coupling condensers C5 and C6
(Continued on page 71)

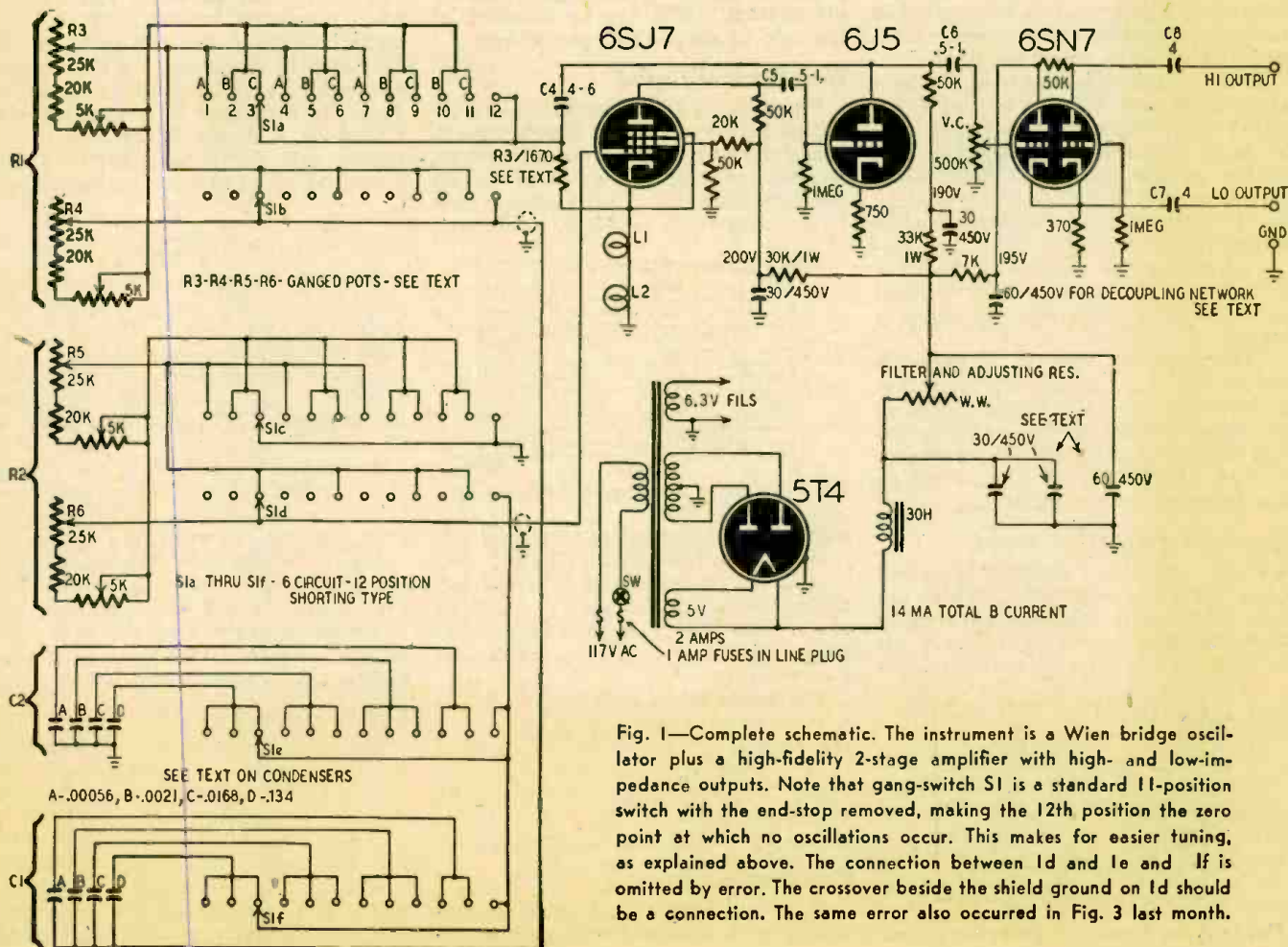



Fig. 1—Complete schematic. The instrument is a Wien bridge oscillator plus a high-fidelity 2-stage amplifier with high- and low-impedance outputs. Note that gang-switch S1 is a standard 11-position switch with the end-stop removed, making the 12th position the zero point at which no oscillations occur. This makes for easier tuning, as explained above. The connection between 1d and 1e and 1f is omitted by error. The crossover beside the shield ground on 1d should be a connection. The same error also occurred in Fig. 3 last month.



Response Equalization

By J. W. STRAEDE

MOST reproducing or recording systems require some form of frequency response correction. The bass or lower frequencies may be attenuated in recording or high frequencies may need emphasizing after passing through a selective radio tuner.

The majority of "tone controls" affect the high-frequency response only, and then only between fixed limits. A few amplifiers are provided with attenuators for low frequencies, but again the rate of attenuation and frequency from which attenuation starts are fixed.

In the system described here, the bass attenuation may start at any of 5 (or more) frequencies, the attenuation may be kept constant below a given frequency or the amount of attenuation may be varied. But that is not all. The lower frequencies may be emphasized or boosted below any of 5 (or more) frequencies, and the amount of boost is controllable. *It is even possible to boost some low frequencies while attenuating others.*

The same thing goes for the high-frequency end of the spectrum, except that in the practical version of the circuit, no provision is made for rate of attenuation above a determined frequency and, instead, sharper cutoff is provided as this is generally more useful.

Response correction types

What are the commonly required types of response correction? There are bass attenuation combined with slight high-frequency boost for ordinary recording, bass boost with extreme high-

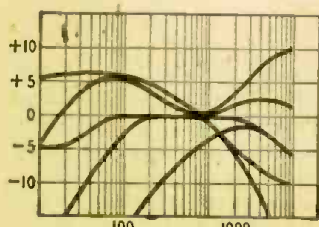

Fig. 1—A few forms of response correction.

frequency boost for orthacoustic recording, the opposites of these first two for reproduction; large bass boost at very low frequencies below the main speaker resonances, high-frequency equalization for good crystal pickups, and the same with a boost of only the infra-low bass for cheaper crystal pickups.

Some of the possible frequency corrections are shown in Fig. 1, a maximum variation of about 10 db being obtainable except for the high-frequency attenuation which can be obtained at the rate of about 12 db per octave.

Simple circuit used

These boosts and attenuations are obtained with a relatively simple circuit. There are no multigang potentiometers, no inductance to pick up hum, and no nonstandard parts. All the work is done by ordinary radio resistors, condensers,

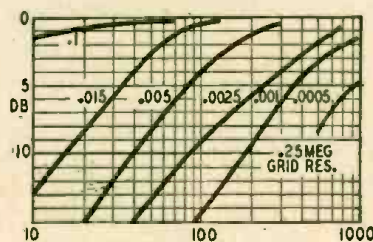

Fig. 2—Effect of coupling condenser on lows.

switches, and potentiometers. The tolerance of the resistors may be 10% and that of the condensers 15% before any noticeable effect occurs (unless, of course, the circuit is used to equalize some amplifier within 1 db for laboratory work).

The whole job is very compact if the power supply is taken from the rest of the amplifier. The single 6J7 or 6SJ7 tube provides a mid-frequency gain of about 10 db after loss in the circuit has been allowed for. All the results are obtained by well-known circuit networks.

Coupling condensers

It is well known that coupling condenser size affects low-frequency re-

sponse. What is not so well known is that the size of the condenser also determines the frequency from which bass attenuation takes place (that frequency is the one at which attenuation is 2 db). The rate of attenuation is approximately 6db per octave and this rate does not depend on condenser size.

In most recording work, the attenuation must start from 250 to 700 cycles, while in public address work the bass cut must begin at about 1,000 cycles when maximum intelligibility and extreme audibility are required. So the first step in designing the circuit was to provide a variable coupling condenser (actually a number of condensers controlled by a simple 5-way switch). A simple rule for determining the frequency at which attenuation commences is

$$f = \frac{R}{5C}$$

where R is the grid resistance in megohms and C is the size of coupling condenser in microfarads. The effects of these condensers is shown in Fig. 2. It might be argued that only a limited number of capacitances is obtainable, but in practice the capacitance is not at all critical.

Amount of low-frequency attenuation is controlled by varying a resistance shunted across the coupling condenser (see Fig. 3). Actually the maximum value of the variable resistance limits the amount of attenuation obtainable—this is usually not of importance, but if necessary the end of the resistance element can be scraped away so that circuit can be opened completely.

Low-frequency boost

The method for boosting the bass is to attenuate to a fixed degree all frequencies above a certain point. This is done by a voltage divider such as is shown in Fig. 4, the lower arm consisting of a resistor and condenser in series. The frequency below which the boost starts is controlled by the condenser size, the maximum rate of boost being

nearly 6 db per octave. Just where the bass boost is to be introduced is decided by the work to be done. When English records are to be played with a "flat" pickup, the boost should commence at about 250 cycles, while for American

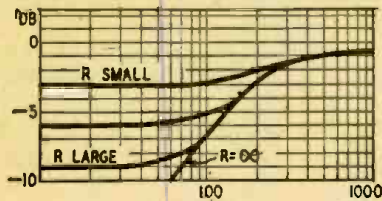
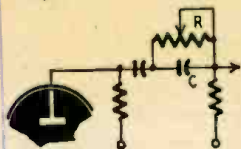

Fig. 3—Bass attenuation control and its effect on tone.



records the boost should start nearer the 700 cycle mark.

To reduce the amount of bass boost the condenser is shunted by a variable resistor. It should be noted that the graphs of Figs. 3 and 4 are similar except that one is inverted; but remember that the bass boost and bass cut can start at different frequencies so that a hump or a dip may be obtained around some frequency.

In Fig. 5 the complete circuit for low-frequency compensation is shown. The values are those which have been found most suitable in practice. Remember that resistor size controls amount of attenuation while condenser size controls the frequency at which a cut or boost commences.

High-frequency equalization

It is well known that high-frequency signals can be attenuated by shunting a condenser between the plate and cathode of a tube. The rate of attenuation at higher frequencies is 6 db per octave, the starting frequency being decided by the type of tube, size of load resistor, and size of shunt condenser. (The load resistor includes the grid resistor effectively connected in parallel as regards h.f. with the resistor that goes to the high-frequency supply.)

For a given product of capacitance and load resistance, a pentode tube gives greater attenuation than a triode, an approximate formula for the attenuation of a pentode being:

$$\text{Attenuation in db} = 20 \log \frac{X_c}{\sqrt{R^2 + X_c^2}}$$

where R is resistance of load and Xc the reactance of the shunt capacitor

$$(X_c = \frac{1}{2\pi f C})$$

where f is the frequency in cycles per second and C is the capacitance in farads).

Such a shunt condenser may not provide sufficiently sharp cutoff. An extra attenuation of nearly the same rate may be obtained by using another shunt condenser at a later point in our circuit, for example, after the 1/4-megohm resistor that supplies signal to the bass-boost network. The reactance of

this condenser, as a first approximation, should bear the same ratio to the 0.025-megohm resistor as the anode shunt condenser bears to the 0.1-megohm anode resistor.

To prevent too much attenuation of the highs when ordinary records (which have only a limited h.f. boost) are played, a resistor may be connected in series with the by-pass condensers, although most people seem to prefer fairly sharp attenuation. High-frequency boosting is wanted for recording and for the realistic reproduction of speech—the former requires a boost commencing at about 1,000 cycles, the latter from 5,000 cycles or from wherever the microphone and speaker performance begin to fall off.

The easiest way to obtain the boost is to connect a small condenser in paral-



Fig. 4—Circuit and effect of bass booster.

lel with the 1/4-megohm resistor that reduces the mid-frequency gain by about 20 db. This shunt condenser reduces the

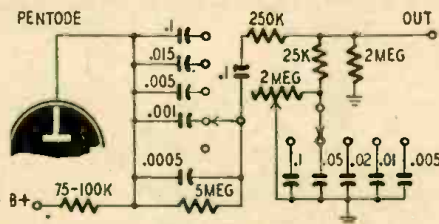

Fig. 5—Practical low-frequency compensator.

loss from over 20 db to about 11 db at high frequencies, so an effective boost of nearly 10 db is obtained. Just as in the rest of the circuit, the capacitance of the condenser is inversely proportional to the frequency at which any given amount of boost occurs, a small condenser of the order of 100 micro-microfarads being required for boosting the frequencies around 10 kilocycles, and about 10 times this capacitance for recording. As shown in Fig. 6, a switch is used to change the capaci-

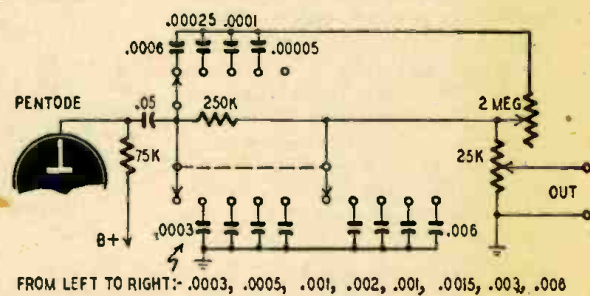

Fig. 6—Circuit for boost and attenuation of the high frequencies.

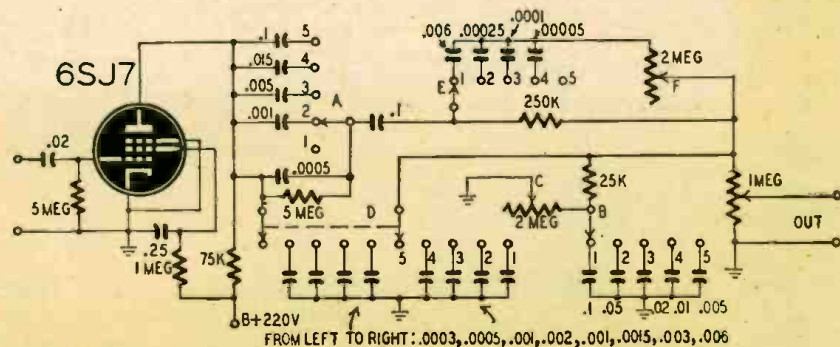

Fig. 7—This complete practical circuit combines all the features of previous figures.

tance. To control the amount of boost and to keep the rise in gain limited to a certain frequency band, a variable resistor is connected in series with the boost condenser.

Fig. 7 is the final practical circuit. A controls the frequency of bass cut, and B the frequency of bass boost. C controls the amount of bass boost. D varies the frequency of cutoff of highs, while E controls the frequency of high boost, and F its amount.

This final circuit is simplified by omitting the variable resistor that had been connected in series with the high-frequency attenuating condensers and also the variable resistor that had been connected across the low-frequency attenuating condensers. It was found that it was far more important to be able to control the frequencies at which attenuation started than to control the amount of attenuation.

Setting of controls

For recording on discs, the low-frequency attenuator (A in Fig. 7) is set to give a fair amount of attenuation. If the recording is done at over 100 lines per inch, the 0.001-μf coupling condenser is used, otherwise the 0.005-μf condenser gives enough reduction. Pipe-organ and dance-band music usually require greater attenuation than a female chorus or soprano singer. If an orthacoustic response is required, a bass boost is provided at the very low frequencies by turning the 2-megohm resistor C to maximum value and setting B to 0.05 μf. Otherwise C is left at minimum resistance and the setting of B is unimportant.

The high-frequency attenuator D is turned off and the high-frequency boost controls are adjusted. E is set to about the middle position and F adjusted to a value of about 0.25 megohm (for a boost of about 5 db).

(Continued on page 77)

Postwar Features of Phonograph Pickups

By I. Queen

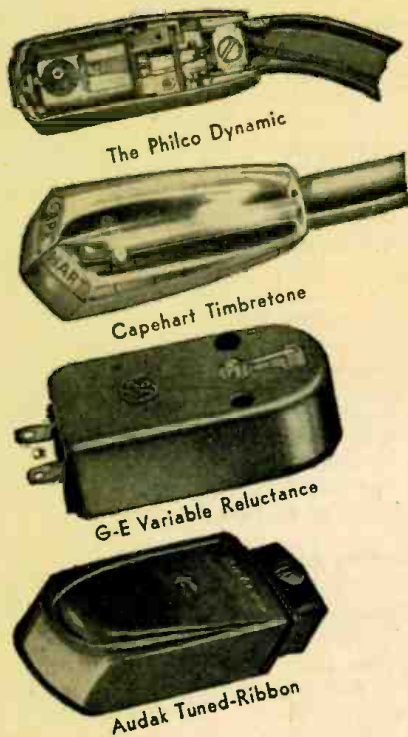

Four of the representative postwar pickups.

WHAT determines a good pickup? The three most important factors are: frequency response, needle pressure, and output level. Postwar pickups show great improvement in the first two, but have lost ground with respect to the last. Also the newer types are more rugged than previous ones.

Pickup designers are now paying special attention to needle pressure. Low pressure means long record life, negligible needle talk, and absence of resonance effects. Modern cartridges can track a record with a pressure as low as ½ ounce (14.3 grams). Much of the improvement has been due to using a lighter stylus assembly. Special mountings, set screws, etc., have been eliminated, and in most cases the stylus is permanently fixed to the cartridge.

The latest pickups have a very low output, only a small fraction of what has been considered normal up to now. Pickup manufacturers realize that low needle pressure and high fidelity are far more important than output level. It has been impossible to obtain all of them, so output has been sacrificed. A stage or two of pre-amplification easily can be built to recover the gain.

The output voltage of most postwar pickups is rated in millivolts instead of

volts. This makes it difficult if not impossible to test a cartridge without additional apparatus. For example, the G-E pickup has an output of 0.011 volt at a stylus velocity of 4.8 cm/sec. This is well below the range of a serviceman's meter. He will miss the easy methods by which he tested high-voltage, high-impedance cartridges. The new pickups and their pre-amplifiers must be treated as a single unit. The various manufacturers recommend circuits which are designed especially for their own products. And these should be used wherever possible. Output of the pre-amplifier is usually 1 volt.

In some pickups there is actually no voltage output at all. For example, the Zenith Cobra pickup is a modulator and not a voltage generator. It modulates an r.f. current which is then detected and

perceived with pickups and if he uses good judgment, there is no reason why a satisfactory job cannot be done. A replacement cartridge should have approximately the same characteristics as the one being replaced, except possibly for output. Manufacturers can provide a recommended circuit diagram to use with their units to bring them up to the level of the higher-output cartridges.

After making a substitution or building a new reproducing unit, always check it on loud and soft recorded passages. Make sure that it does not overload. On the other hand, it should have ample reserve volume. Equalization should be balanced between the highs and the lows, unless the listener prefers it otherwise. A variable tone control always helps.

New crystal pickups

The crystal pickup is still the most widely used. It gives reasonably high fidelity and plenty of output at moderate cost. Most new crystal cartridges are available with permanent stylus, but one type (the Astatic) has a replaceable, sapphire-tipped, nylon needle held in a nylon chuck (Fig. 1). The needle can be removed by an ejector screw fitted into a hole in the mounting. A new needle of the same type can then be inserted into the tapered groove. Nylon has very low weight as well as self-damping properties which reduce resonance.

Sound technicians know the simple equalizers which are ordinarily used with a crystal pickup. They may be interested in a more elaborate type designed by Brush (Fig. 2). This network reproduces either Orthacoustic transcriptions or commercial records with correct compensation. The four positions are for: (1) quiet commercial records with 500-cycle turnover; (2)

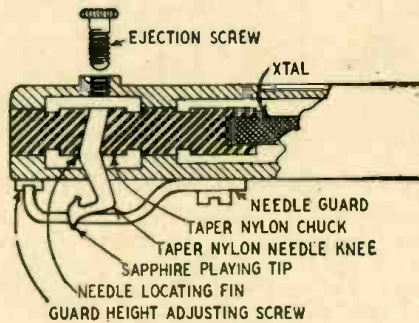

Fig. 1—Cross-section of new Astatic pickup.

amplified. Evidently it cannot be tested without the apparatus it is designed to work with.

Servicemen can expect many requests to modernize existing reproducers by substituting advertised cartridges. As a general rule, manufacturers advise against this because pickups differ in many ways. Still, if the technician is ex-

Fig. 2—Schematic of the Brush equalizer.

Left—Zenith's Cobra, showing vane and coil.

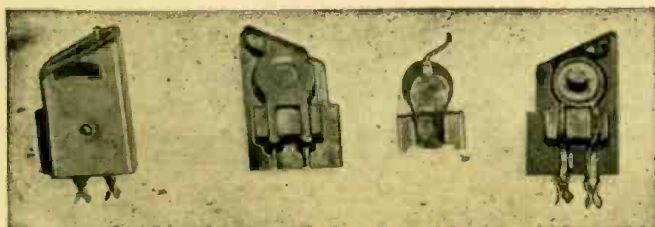
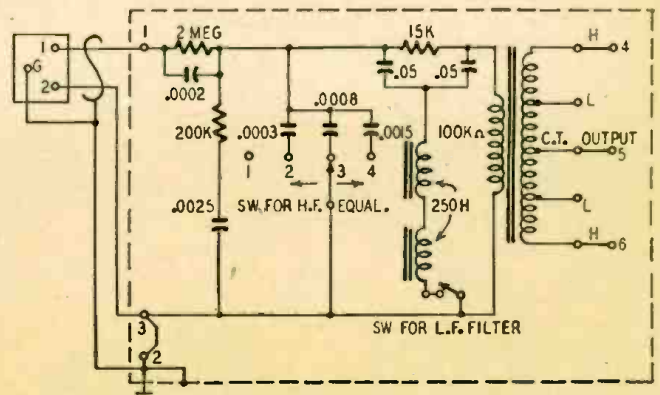

scratchy and noisy commercial records; (3) good Orthacoustic transcriptions; (4) noisy transcriptions. The low-frequency filter eliminates turntable rumble and line-frequency pickup.

Variable-reluctance pickup

The General Electric variable-reluctance pickup is a magnetic type which has high-fidelity response (to 10,000 cycles without resonance). The stylus has a natural sapphire tip and is fixed to the cartridge. Only lateral vibrations produce output. This reduces noise which might be caused by vertical motion in the grooves.

This pickup has an internal resistance of 300 ohms and an inductance of 100 millihenries. Output is 0.011 volt. Hum pickup from nearby transformers

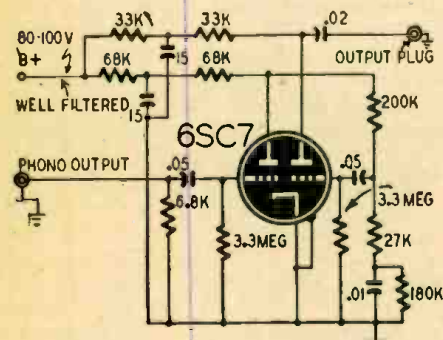

Fig. 3—A pre-amplifier for the G-E pickup.

and filters is reduced by shielding. The pre-amplifier of Fig. 3 is recommended for this unit.

Philco dynamic pickup

The Philco dynamic pickup operates like the movement of a d'Arsonval meter (Fig. 4). A thin duraluminum cone carries 2 layers of No. 36 aluminum wire wound to a resistance of 3 ohms. The coil vibrates in the field of an Alnico magnet. The rubber damping is

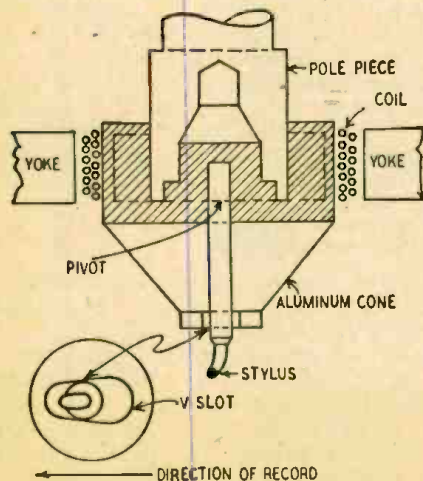

Fig. 4—Simplified drawing of Philco pickup.

designed for a cutoff between 4,000 and 5,000 cycles.

The sapphire-tip stylus is replaceable. It can be used for about 2,000 playbacks. A needle guard is provided to

protect the stylus. It also prevents excessive side motion of the needle.

The coil has such low resistance that it must be matched through a special transformer (Philco part 32-8256). A 0.002- μ f condenser and a 220,000-ohm resistor are connected in series across the secondary winding. The transformer output is approximately 1 volt.

Audok tuned-ribbon

Although actually a magnetic reproducer, the Audok pickup is unconventional in design, operation, and results. A tiny piece of magnetic material is



Fig. 5—Moving parts of tuned-ribbon pickup.

fixed to the armature just above a permanent stylus (Fig. 5). Motion of the armature is limited by the 2 ribbons which hold it. These ribbons, made of Invar or similar metal, are tuned to a high frequency so that the response is a straight line up to 15,000 cycles. Because of the ribbon action, there is no need for rubber or similar damping, which has always caused difficulties in magnetic pickups. The same pickup may be used to reproduce either lateral or vertical recordings. Tuned-ribbon pickups are produced in a number of models, most of them intended for broadcast studio use, some of them being flat from 20 to 15,000 cycles. The types the serviceman is most likely to meet, Models R-55 and R-61, are adapted to reproduction of lateral recordings up to 12 inches, and are linear from 50 to over 8,000 cycles. Standard impedance is 200 ohms, though it may be made in any impedance. Output is approximately 0.2 volt to a perfectly matched load.

Zenith Cobra

The Zenith Cobra has a permanent stylus held by a thin flat wire to a steel vane. This vane is in the field of an r.f. coil, and therefore induces eddy-current losses. The loss changes with the position of the vane. When it vibrates, the r.f. current in the coil is modulated at an audio rate. See Fig. 6 for Zenith's own representation of the action of their pickup.

This pickup is used with a circuit similar to Fig. 7. The first triode is a Hartley oscillator tuned to about 2.5 mc, and it is also a grid-leak biased

detector. The second triode is a straight audio amplifier.

R.f. amplitude at the first grid is 1.5 volts. The audio voltage is only 0.01

volt, due to the low modulation percentage. Mechanical and electrical components are designed for a 4,000-cycle cutoff.

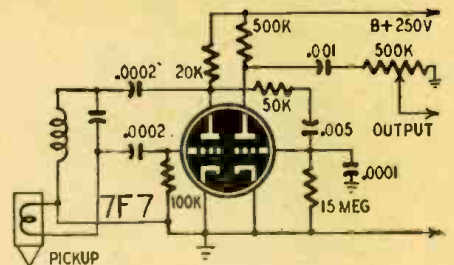

Fig. 7—Oscillator circuit of Cobra pickup.

The strain-gage pickup

The Capehart pickup operates like a variable-resistance strain gage. It modulates a direct current,

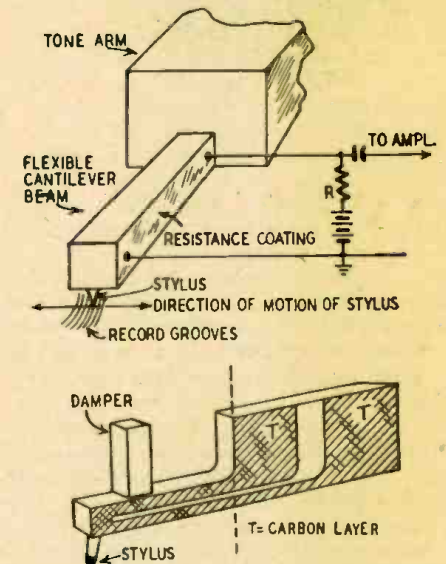

Fig. 8—Construction of strain-gage pickup.

creating a voltage within itself. A carbon particle mixture is painted on both sides of a small beam (Fig. 8). When this beam vibrates, one side stretches and the other contracts, causing the resistance to vary. (The average resist-

(Continued on page 55)

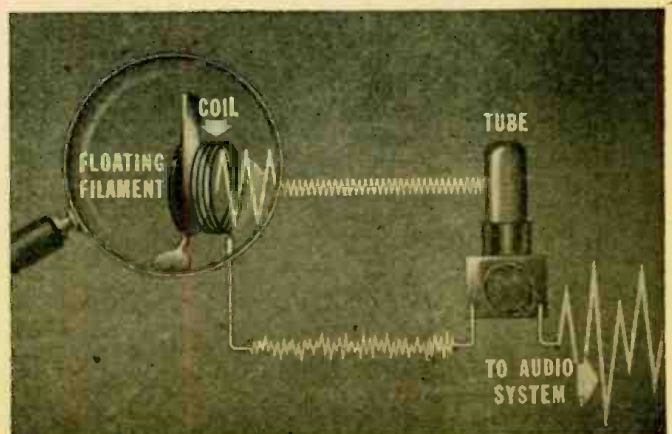
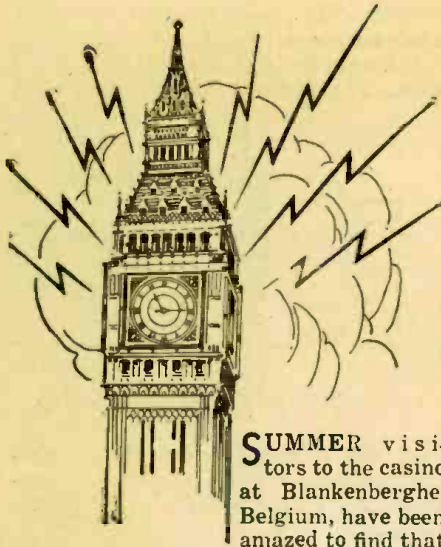

Fig. 6—Symbolic representation of the action of Zenith Cobra radio-frequency pickup

Transatlantic News

By Major Ralph W. Hallows

RADIO-CRAFT EUROPEAN CORRESPONDENT



SUMMER visitors to the casino at Blankenberghe, Belgium, have been amazed to find that

television signals originating in London—a distance of 130 miles—are received regularly in the afternoon and evening.

The televiser operates from a 70-foot antenna erected above the casino. The visual horizon from a height of 70 feet is only about 10 miles. If a line-of-sight path is followed by the 40-mc transmissions, the London transmitting antenna would have to be over 6,000 feet above sea level for reception to be possible. Daily reception rules out the possibility of freak conditions often responsible for the spanning of long distances by v.h.f. This therefore must be direct-ray reception, and it is proof that the v.h.f. rays curve during passage through the atmosphere. The formula for finding the approximate length of the path of quasi-optical waves; Distance (miles) equals $1.4\sqrt{H}$, includes the constant 1.4 to compensate for refraction of radio waves at ultra high and very high frequencies. (Similar results have been observed in the U. S. with television and old-band FM signals.—*Editor*)

In England there is a small boom in the sale of television receivers. Receiving licenses now number 18,500, of which some 2,500 are probably held by professionals and 16,000 by owners of domestic televisers. Not a large total, but it represents an increase of over 2,000 in the last few weeks; and that means that television receivers are now being sold just about as fast as they are being turned out by the factories. Shortages of materials, fuel, and labor limit the manufacturer's output considerably; and the supply, particularly of the better-class instruments, is not keeping pace with the demand.

Compact mobile pickup

It has been felt that television will not become really popular unless it concerns itself largely with the transmission of news pictures. Horse races, football, tennis, and other games, boxing matches and parades are always welcome items. For such purposes mobile televising equipment and movie trucks are required. One of the handiest mobile television pickup outfits available has just been produced by the Pye Radio Co. of Cambridge, England. The equipment,

including 2 dolly-mounted iconoscope cameras, a control room with twin monitor tubes, a 50-watt, 660-mc transmitter, and a 40-foot telescopic antenna, is carried in a small utility-type truck. The antenna is raised and lowered by a motor. Each camera dolly has 100 feet of cable containing 5 shielded pairs and 9 unshielded leads. Power may be obtained from a built-in 3.5-kw generator or from supply lines when available. The truck picks up on-the-spot pictures and relays them to a main television station for broadcast. The crew of three is always under the direction of the producer at the main station. Contacts are maintained by a separate intercommunication transceiver on an independent channel.

D-layer reflections

During the last 20 years reports have been received from time to time of the reflection of long-wave radio signals, apparently from a region considerably below the Heaviside or E-layer. Such reflections occur only by day and are confined usually to a belt extending some 30 degrees north and south of the equator. They have been observed on very rare occasions in localities in England and Canada. During the war, reflections of Loran signals were found in tropical regions. A party of New Zealand physicists on Pitcairn Island kept records over a period of more than a year. An analysis of these by C. D. Ellyet furnishes convincing evidence of the existence of a D-layer at a height of about 30 miles. In a series of nearly 2,000 daylight observations reflection from the D-layer was recorded on no less than 1,302 occasions; but in 1,200 observations made after dark only 2 instances of reflection were recorded. In the comparatively dense atmosphere at a height of 50 miles the recombination

of atoms and electrons must be rapid once the sun has set and the ultraviolet rays no longer maintain a state of ionization. The meteors and meteoric dust which ionize the E-layer by night have lost their ionizing power by the time that they have penetrated as far as the D-layer. Ellyet concludes from his analysis of that D-layer reflection has been established beyond any possibility of doubt. He holds that it may be a factor of some importance in daytime radio transmission in the tropics, but that it occurs in other regions rarely and as a result of abnormal conditions.

Why is the earth a magnet?

Every long-distance radio enthusiast has had practical experience of some of the effects of the earth's magnetic field, and others use the effects when navigating by compass. There is no doubt that the earth is a gigantic magnet. Why should the earth be a magnet at all? A most ingenious answer was given by Professor P. M. S. Blackett, of Manchester University, at a recent meeting of the Royal Society. He contends that any body having mass must become a magnet if it rotates, and that the degree of magnetism is in proportion to the rate of spin. Blackett bases his theory on the known facts about the earth and the sun and on the measurements of the magnetic field of a star made recently at Mount Wilson by Dr. Babcock. He has calculated that in each of these cases the magnetic moment is in proportion to the angular momentum. Admittedly, his evidence is drawn from only three of the millions of rotating bodies in space; but if further measurements confirm his theory, he will have opened the way for a vastly important new line of research into the interconnection of gravity, magnetism, and electricity.

SIMPLE SILVER PLATING

Copper wire and copper strip, for high-frequency radio components, can be silver-plated without using electrical circuits by rubbing on a paste made from silver chloride and cream of tartar. The quantities and purity of either ingredient are not at all critical.

The silver chloride is not stable in the presence of light, but is easily made. Either use 2 or 3 crystals of silver nitrate (lunar caustic) dissolved in water, or dissolve a scrap of silver in nitric acid and dilute the remaining fluid with water. Add to this a solution of common salt in water, which should precipitate the white chloride.

When this settles, pour off the excess liquid. Then add clean water and shake up. Allow the chloride to settle again, pour off the water, and repeat this washing process 3 or 4 times. Finally add dry cream of tartar to form a paste.

Clean the copper well, moisten with a salt solution, and then rub on the paste with a soft rag. This forms a coating of silver (not quicksilver) which is permanent in its qualities.

Thickness of the finished coat depends on the amount of rubbing and the process can be repeated as many times as necessary.—*R. Kerr in Radio and Hobbies (Australia).*

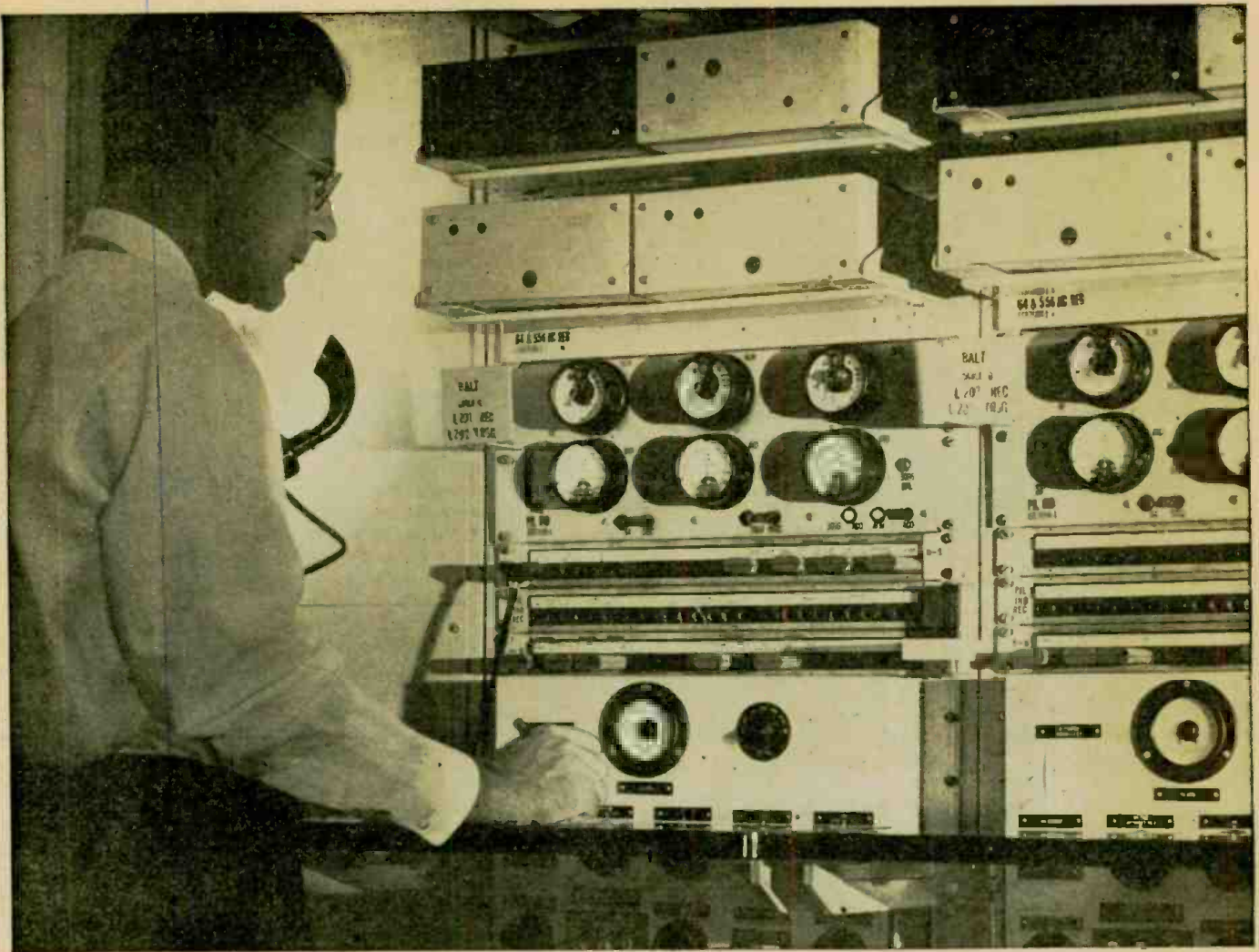

At Philadelphia, a testboard man answers as an electronic watchman calls attention to conditions on one of the coaxial systems to Baltimore and Washington.

“Send Help to Manhole ‘83”

Strung out along every Bell System coaxial cable, electronic watchmen constantly mount guard over your voice. Some are in manholes under city streets; some are in little huts on the desert. Most situations they can deal with; if things threaten to get out of hand, they signal the nearest testboard.

Principal care of the electronic watchman is the transmission level. Sunwarmed cables use up more energy than cold ones, so a transcontinental call may take a millionfold more energy to carry it by day than by night.

Each watchman — an electronic regulator — checks the transmission level and adjusts the amplification which sends your voice along to the next point. Many hundreds of regulators may be at work on a single long distance call.

Without automatic regulation, the precise control of energy in the Bell System's long distance circuits would be a superhuman task. So Bell Laboratories, which in 1913 developed the first high vacuum electronic amplifier, went on to devise the means to make them

self-regulating in telephone systems. This is one reason why your long distance call goes through clearly, summer or winter.

BELL TELEPHONE LABORATORIES

Exploring and inventing, devising and perfecting for continued improvements and economies in telephone service.



NEW RADIO-ELECTRONIC DEVICES

TUBE TESTER

Electronic Measurements Corp.
New York, N. Y.

The Model 200 tube tester is a flexible mutual-conductance device indicating the quality of a tube on a calibrated mutual-conductance scale as well as a REJECT-GOOD scale. It

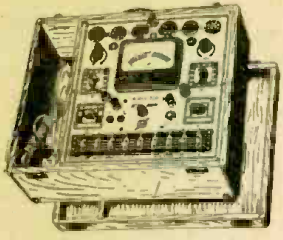

tests tubes for gas as well as for open and shorted filaments. Filament voltages for all tubes between 0.75 and 117 volts are available.

This model is available with either 3- or 4 1/2-inch meters and sloping counter case or portable carrying case.—RADIO-CRAFT

FREQUENCY METER

Browning Laboratories, Inc.
Winchester, Mass.

The Model MJ-9 frequency meter is designed for checking frequencies of FM and AM amateur transmitters operating in any band from 3.5 to 148 mc. Bands covered are 3.5-4.0, 7.0-7.3, 14.0-14.4, 20.5-21.5, 28.0-29.7, 50.0-54.0, and 144-148 megacycles.



The meter is direct-reading and employs separate coils for all except the 144-148-mc band, which is covered by harmonics of the 20.5-21.5-mc band. A 500-kc crystal-controlled oscillator is used as a reference standard. The accuracy of the meter is 0.05 percent at all frequencies.

The Model MJ-9 may be used as a v.f.o. transmitter control by using a class A amplifier between it and the transmitter.

The meter is housed in a steel cabinet 7 x 10 x 8 1/4 inches.—RADIO-CRAFT

SIGNAL TRACER KITS

Special Products Company
Silver Spring, Md.

The Models STAB-KIT and STAC-KIT signal tracer kits are battery- and a.c.-



operated respectively. These kits are designed for servicemen, amateurs, and experimenters who like to build their own equipment.

The kits contain parts identical with those used in the completed models offered by the company. All components are packed in individual envelopes or tagged for accurate identification by the builder. Circuit diagrams, pictorials, and assembly and operating instructions are included in each kit.—RADIO-CRAFT

ARTIFICIAL EAR COUPLER

Massa Laboratories, Inc.
Cleveland, Ohio

The Model M-112 artificial ear coupler is designed to couple headphones to a standard microphone or other sound pressure measurement equipment when checking phone re-

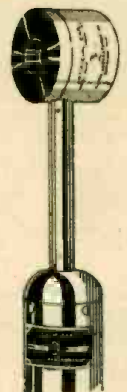

sponse. It consists of a 2-piece stainless steel chamber which provides a 2-cubic-centimeter cavity for insert-type phones and a 6-cc cavity for phones which are generally worn with headbands.

Sound measuring equipment is inserted in a special opening in one side of the cavity.—RADIO-CRAFT

MINIATURE STORAGE CELL

The Vitamite Co.
New York, N. Y.

The Model 2A0.45 (Flyweight) wet cell is ideal for use as filament supply for miniature and subminiature tubes used in hearing aids, pocket radios, and other electronic equipment. The

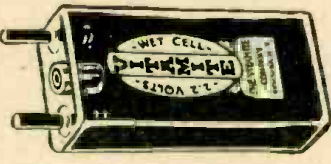

battery has a non-flowing electrolyte and is sealed in a one-piece leakproof plastic case, 9/16 x 7/8 x 1 13/16 inches. It weighs 1 ounce. Its voltage remains constant through 95% of its useful life with one charging.

It is smaller than two pentite dry cells and delivers 2.2 volts for 450 milliampere-hours—50% more wattage than 2 type C dry cells—on a single charging.

The Bantamweight model delivers 4.4 vpts for 900 milliampere hours; the Model 2A3.00 delivers 2.2 volts for 3 ampere-hours. These units are slightly larger than the Flyweight model. Chargers are available for all models.—RADIO-CRAFT

RECORD CHANGER

V-M Corporation
Benton Harbor, Mich.

The V-M Corporation Model 400 automatic record changer plays ten 12-inch or twelve 10-inch records or any



mixed selection of ten 10- and 12-inch recordings. Records change in less than 4 seconds. Operation is unaffected by warped surfaces or uneven edges. Inside-out home recordings can be played by operating with the control knob in the manual position. Records are lowered, not dropped, on the turntable.

The tone arm is mounted on ball bearings for easy tracking and tripping. A 3-position control knob has settings for on, off, and reject operation. Needle-height and set-down adjustments are made from above the base plate.

The changer fits in a mounting space 13-13/16 inches wide by 1 1/4 inches deep. It is 7 3/8 inches high over-all with 5 3/8 inches above the mounting board. It operates from 110 to 120 volts, 60-cycle a.c.—RADIO-CRAFT

CO-AXIAL RELAY

Signal Engineering & Mfg. Co.
New York, N. Y.

This new co-axial relay is designed for switching antenna connections from



transmitter to receiver with provisions for impedance matching with low standing wave ratio. It uses a s.p.d.t. switch with silver current-carrying elements within a metal enclosure or cavity of correct proportions to produce a characteristic impedance of 75 ohms. Threaded nipples are provided for cable connectors. Models are available for operation from 6, 12, 24, 32, and 110 volts d.c. and 115 and 230 volts, 60-cycle a.c. All models are enclosed in a sheet-metal housing, 3 3/4 x 4 x 3-1/16 inches, for indoor installations.—RADIO-CRAFT

5-TUBE SUPER KIT

General Electric Co.
Syracuse, N. Y.

These radio receiver construction kits for radio education applications include all parts necessary for building a complete 5-tube superheterodyne receiver: a punched chassis, tubes, loop antenna, 5-inch speaker, and specially written instructions and diagrams. Students may perform experiments on various circuits in the receiver.—RADIO-CRAFT

CRYSTAL MICROPHONE

Shure Brothers
Chicago, Ill.

The new Model 718A Versatex is a high output diaphragm-type crystal microphone suitable for placing on a table top or other flat surface. It fits conveniently in the palm of the hand for use as a hand mike and may be mounted on a conventional floor stand if desired.

It has semidirectional properties. A built-in protective resistor prevents burn-outs when used with radio transmitters. The housing is molded Plaskon.—RADIO-CRAFT

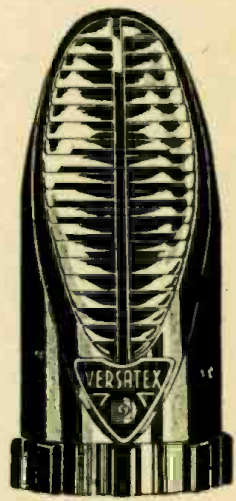

RECORDING MACHINE

Robinson Recording Laboratories
Philadelphia, Penna.

The new Robinson professional recording machine is designed for use in radio stations, recording studios, and other installations. The recording chassis is on a cast aluminum bedplate with a cast-in control panel for meter, fader, and switches. The cutter carriage and pitch-change box are chrome-plated aluminum. Two types of cutter carriages accommodate any existing type of recording head. The standard unit takes RCA, Presto, and other small cutting heads, while the second model is made for WE wax cutters. A 4 to 1 gear control is provided for spiraling.

Records may be cut at 85, 100, 120, 130, and 140 lines per inch with instantaneous change while recording. Selection of outside-in or inside-out recordings and micrometer speed adjustments are made with toggle levers.



The unit does not have to be leveled under ordinary conditions. Less than 10 seconds are required for change of discs and recording conditions.—RADIO-CRAFT

MONEY BACK GUARANTEE — We believe units offered for sale by mail order should be sold only on a "Money-Back-If-Not-Satisfied" basis. We carefully check the design calibration and value of all items advertised by us and unhesitatingly offer all merchandise subject to a return for credit or refund. You, the customer, are the sole judge as to value of the item or items you have purchased.

The New KT-30 CHANNEL ANALYZER

The Ultimate in Signal Tracing Includes . . .

METER—For direct reading of signal intensity.

SPEAKER—For listening to the signal.

PHONE—For checking distortion and listening to the signal in low-gain channels.

Comparative signal intensities indicated directly on the meter as Probe follows the signal. A special 4½" P.M. speaker with oversize Alnico V magnet is used for quality checks. Many previously designed Signal Tracers were unable to measure and check low signal intensities. This disadvantage has now been overcome for the Model KT-30 incorporates a special circuit which permits the meter to be put across the output of the Signal Tracer. To accomplish this it is necessary only to flip a front panel switch. This results in additional gain and sensitivity permitting measurement of low signal intensities. An earphone provided with the unit permits listening to the signal in low-gain channels. Incidentally, insertion of the phone automatically cuts out the speaker.

\$29⁹⁵ NET

Complete with detector probe, test leads, self-contained batteries and earphone. Heavy-gauge crystalline cabinet.



The New Model 650-A A. C. Operated SIGNAL GENERATOR



- Operates on 110-120 Volts 50 to 60 Cycles A.C.

- R.F. Frequencies from 100 Kc. to 35 Mc. on Fundamentals in 5 bands by front panel switch manipulation. One additional band provides Harmonics from 30 to 105 Mc.

- Audio Modulating Frequency —400 Cycles Pure Sine Wave. Distortion less than 2%.

- Attenuation: Features a newly designed 3-step ladder type of attenuator (T pad). The first step provides lowest output and can be multiplied by 10 and by 100 by turning the multiplier switch.

- Hartley Excited Oscillator Electron coupled to a Buffer Amplifier. Frequency stability is assured by modulating the amplifier stage.

Complete with coaxial cable, test leads and instructions. Heavy gauge grey crystalline cabinet with beautiful two tone etched front panel. Size 9½" x 10" x 6".

\$39⁹⁵ NET

The New Model 670 SUPER METER

A Combination Volt-Ohm-milliammeter plus Capacity Reactance, Inductance and Decibel Measurements

D.C. VOLTS: 0 to 7.5/15/75/150/750/1500/7500.

A.C. VOLTS: 0 to 15/30/150/300/1500/3000 Volts.

OUTPUT VOLTS: 0 to 15/30/150/300/1500/3000.

D.C. CURRENT: 0 to 1.5/15/150 Ma.; 0 to 1.5 Amps.

RESISTANCE: 0 to 500/100,000 ohms 0 to 10 Megohms.

CAPACITY: .001 to .2 Mfd., .1 to 4 Mfd. (Quality test for electrolytics).

REACTANCE: 700 to 27,000 Ohms; 13,000 Ohms to 3 Meg-ohms.

INDUCTANCE: 1.75 to 70 Henries; 35 to 8,000 Henries.

DECIBELS: -10 to +18, +10 to +38, +30 to +58. The Model 670 comes housed in a rugged, crackle-finished steel cabinet complete with test leads and operating instructions. Size 5½" x 7½" x 3".

\$28⁴⁰ NET



The New Model CA-11 SIGNAL TRACER



Simple to operate . . . because signal intensity readings are indicated *directly on the meter!*

- ★ **SIMPLE TO OPERATE** —only 1 connecting cable —**NO TUNING CONTROLS.**

- ★ **HIGHLY SENSITIVE**—uses an improved Vacuum Tube Voltmeter circuit.

- ★ Tube and resistor-capacity network are built into the Detector Probe.

- ★ **COMPLETELY PORTABLE** — weighs 5 lbs. and measures 5"x6"x7".

- ★ Comparative Signal Intensity readings are indicated directly on the

meter as the Detector Probe is moved to follow the Signal from Antenna to Speaker.

★ Provision is made for insertion of phones. The Model CA-11 comes housed in a beautiful hand-rubbed wooden cabinet. Complete with Probe, test leads and instructions.

\$18⁷⁵ NET

The New Model 450 TUBE TESTER

Speedy operation — assured by newly designed rotary selector switch which replaces the usual snap, toggle, or lever action switches.

SPECIFICATIONS

- Tests all tubes up to 117 volts.
- Tests shorts and leakages up to 3 Megohms in all tubes.
- Tests both plates in rectifiers.
- New type line voltage adjuster.
- Tests individual sections such as diodes, triodes, pentodes, etc., in multi-purpose tubes.
- Noise Test-detects microphonic tubes or noise due to faulty elements and loose internal connections.
- Uses a 4½" square rugged meter.
- Works on 90 to 125 volts 60 cycles A.C.

EXTRA SERVICE—May be used as an extremely sensitive condenser Leakage Checker. A relaxation type oscillator incorporated in this model will detect leakages even when the frequency is one per minute.

\$39⁵⁰ NET



GENERAL ELECTRONIC DISTRIBUTING CO. DEPT. RC-9, 98 PARK PLACE, NEW YORK 7, N. Y.

RADIO-ELECTRONIC CIRCUITS

VARIABLE B-SUPPLY

A simple and inexpensive variable B-supply that will prove useful to experimenters and technicians was developed by Messrs A. H. Broly and J. L. Lahey for use in the laboratory of the Radio Materiel Section of the Naval Training School at Chicago.

As described in *Electronics*, the circuit can be readily added to almost any

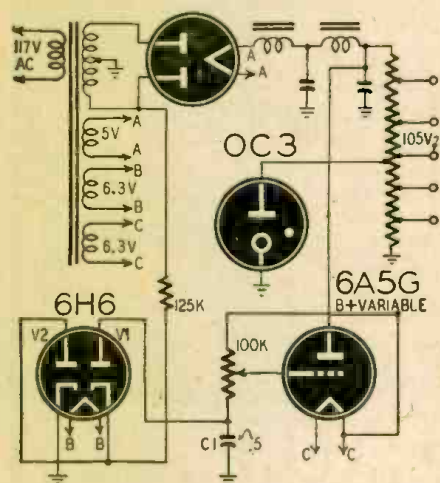

power supply delivering 60 or 70 ma at about 350 volts. Most commonly used voltages are available from semifixed taps on the bleeder system. Continuously variable voltages are available at a separate B-plus terminal.

Variable output voltage is obtained by using the plate resistance of a 6A5G, 6A3, 2A3, or similar tube, as a variable resistance in series with the load. This resistance is variable from about 900 ohms to infinity by varying the bias voltage from zero to ≈ 100 volts. A separate filament winding is required for this tube as its filament potential is equal to the voltage at the variable output terminal.

Bias for the control tube is provided by a 6H6 rectifier and is filtered by the potentiometer and C1. The cathode of one section of the 6H6 rectifier, V1, is connected to one side of the high-voltage winding through a 125,000-ohm resistor having a rating of 3 to 5 watts. The other section of the 6H6 is connected in reverse so current flows through this resistor at all times. Voltage developed here keeps the peak inverse voltage within the limits of the 6H6 and prevents cathode-to-ground potential from exceeding the rated cathode-to-heater voltage. This makes it practical to operate the 6H6 from a filament supply common to other tubes where one side of the winding must be grounded.

Current through the control tube must return to ground either through the load or through the control tube. In either

case, the return current is in the opposite direction to the load current and a small counter voltage is developed. This may be appreciable when the control is adjusted for low output voltage. This voltage may be neutralized by varying values of the 125,000 and 100,000-ohm

RADIO-CRAFT presents this month, instead of its usual radio-electronic circuits, a selection of the best of those which have appeared in recent technical literature. If readers approve of the new system it will be adopted. Let us hear what you think.

resistors so that the control tube passes sufficient current to balance exactly the bias voltage and bring the output voltage to zero when the control is adjusted for minimum voltage.

When a 0.5- μ f condenser is used for C1, a small 60-cycle ripple may be noticeable when the supply is lightly loaded with low output voltages. This may be improved by using a larger capacitor at this point. A paper condenser should be used as there is a tendency for the bias supply to reverse polarity by a few volts.

When regulated voltages are required, voltage regulator tubes such as the OA3, OC3, and OD3 may be connected to the proper point on the bleeder to provide 75, 105, and 150 volts, respectively.

If more than 70 ma is to be drawn from the variable source, 2 or more control tubes should be operated in parallel with 50- to 500-ohm resistors in the grid leads to suppress parasitics.

MODULATION INDICATOR

The simple no-power modulation meter is a welcome addition to the auxiliary equipment in amplitude-modulation amateur radiotelephone stations. As described in a recent issue of *Sylvania News*, it uses a d.c.-milliammeter and two 1N34 crystal diodes as an r.f. and a.f. voltmeter to compare the carrier voltage with its audio component.

The meter is coupled to the final tank of the transmitter through a 1- or 2-turn link and a length of 75-ohm line

connected to the input terminals. A 0.001- μ f ceramic condenser guards the instrument against possible d.c. voltages. The 100- μ f variable trimmer



Commercial model of the modulation meter.

tunes the input circuit to the frequency of the transmitter. R.f. voltages develop across D1 and the 1,000-ohm resistor. When S1 is in the r.f. position, the diode is used with the meter as a peak-reading r.f. voltmeter. Its diode load resistor, R1, is chosen so that a reasonable amount of r.f. at the input terminals will cause full-scale deflection of the meter for voice modulation and 70% of full scale for tone modulation.

The meter reads percentage of modulation directly when S1 is in the a.f. position. One half the primary of a push-pull interstage transformer, with a 1-to-1 ratio, is the diode load. The a.f. component is rectified by D2 and indicated on the meter as percentage modulation. S2 is a circuit-reversing switch used to switch between positive and negative a.f. peaks and to check the symmetry of modulation. To indicate carrier shift, throw S1 to r.f. and compare the readings with and without modulation. If they differ by more than 2 or 3%, check the transmitter for sources of the trouble.

Plug a pair of high-grade phones in the jack to check the signal for hum, a.f. oscillations, and modulation quality.

Circuit diagram. The unit is very simple for the versatility of its applications. Two 1N34 crystals rectify the current for the 1-ma meter.

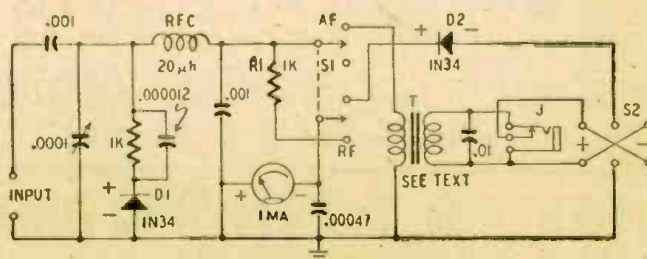



**What Kind of Serviceman Will
You Be 5 Years from Now?**

**RADIO-ELECTRONICS SERVICING
Will Advance Unbelievably
During the Next Few Years
AND THE FIELD IS "WIDE OPEN"!**

Never were there such opportunities as now exist in the expanded field of radio-electronics servicing! Thousands of highly-trained, expert electronics technicians are required—and the field is wide open.

Little competition is to be expected from the pre-war serviceman who has not modernized his knowledge through training. The new types of AM and FM receivers, Television, Facsimile, plus the many types of communication and industrial electronic equipment being installed everywhere, require newly trained, highly skilled electronics service engineers and technicians.

The average "screwdriver" serviceman is on his way out, and the trained electronics service engineer is on his way in. Honestly ask yourself if you are equipped to qualify for maintenance and service work in this new, broadened service field. If not, you are

limiting your own opportunities in a field that drastically needs trained men.

You can enjoy a permanent, profitable and lasting career in fascinating service work. Join the many professional servicemen who are now studying CREI courses in spare time... protecting their future jobs, their businesses, by acquiring new "know-how" now. CREI's reputation for home study training has been proved over 20 years. Important new electronics developments are covered in the CREI courses. Trained instructors give you personalized attention and step-by-step guidance all the way.

What you decide today may be the answer to the success you hope to attain 5 years from now. It costs you nothing but a few minutes time to read the revealing facts — to learn how CREI can help you enjoy the future you want. Write today.

VETERANS! CREI TRAINING AVAILABLE UNDER THE "G.I." BILL!

MAIL COUPON FOR FREE BOOKLET

If you have had professional or amateur radio experience and want to make more money, let us prove to you we have the training you need to qualify for a better radio job. To help us intelligently answer your inquiry — IN WRITING PLEASE STATE BRIEFLY YOUR BACKGROUND OF EXPERIENCE, EDUCATION and PRESENT POSITION.



Capitol Radio Engineering Institute

An Accredited Technical Institute

DEPT. RC-9, 16TH AND PARK ROAD, N. W., WASHINGTON 10, D. C.

Branch Offices: New York (7): 170 Broadway • San Francisco (2): 760 Market St.

CAPITOL RADIO ENGINEERING INSTITUTE
16th & Park Rd., N. W., Dept. RC-9 Washington 10, D. C.
Gentlemen: Please send me your free booklet, "CREI Training for Your Better Job in RADIO-ELECTRONICS", together with full details of your home study training. I am attaching a brief resume of my experience, education and present position.

Check PRACTICAL RADIO ENGINEERING
Course PRACTICAL TELEVISION ENGINEERING

NAME _____

STREET _____

CITY _____ ZONE _____ STATE _____

I am entitled to training under the "G.I." Bill.

TRANSVISION

TELEVISION KIT

4 GOOD DOLLARS-AND-SENSE REASONS WHY
The TRANSVISION TELEVISION KIT
IS THE CHOICE OF DISTRIBUTORS, DEALERS
AND THOUSANDS OF USERS!

BIGGEST VALUE
LEADING "BUY" IN THE FIELD

TOP QUALITY
IN EVERY PART

NEW SYNC. CIRCUIT
GIVES STABLE PICTURE

**BACKED BY EXTENSIVE
NATIONAL
ADVERTISING**



• **BIGGEST VALUE:** When assembled the Transvision Kit becomes a television receiver worth more than twice its cost. The quality of performance has been acclaimed superior to other available sets by over 10,000 satisfied users.

The kit is **COMPLETE** with sight and high fidelity sound reproduction. Nothing more to buy. No technical knowledge required for assembly. Our complete easy-to-follow instruction sheet gives you all the knowledge you need. No test equipment needed. All difficult assemblies such as the R.F. Unit, I.F. Transformers, are factory wired and pre-tuned.....NET \$159.50 (fair traded).

• **TOP QUALITY PARTS:** You get a brilliant 7-inch Lectrovision Picture Tube, all other 17 tubes; pre-tuned R.F. Unit, tuned I.F. Transformers, 6" speaker, and all other necessary parts including a finished front panel, solder, hook-up wire, a **NEW SPECIALLY DESIGNED FOLDED DI-POLE ANTENNA** with 60 feet of low-loss lead in cable. The total value of all these parts would come to over \$300.00 list.

• The **Pre-tuned R.F. UNIT** mentioned above is the heart of the television set. It is completely wired, pre-tuned, and tested by Transvision. Includes 6C4 oscillator and 6AC7 converter tubes. Designed for high conversion gain and 6mc bandwidth. Nothing for you to do but install.



• **NEW SYNC. CIRCUIT** achieves stable picture, sharp focus. Engineered by Transvision. It gives a maximum of picture stability even in areas of low signal strength or high noise levels. Clear enjoyable reception assured.



BEAUTIFUL CABINET: Transvision offers a beautifully-styled cabinet exclusively designed for their kit. Made of selected grain wood with attractive hand-rubbed walnut finish. An accessory kit is included for use in mounting the assembled Transvision set into the cabinet. Overall size 17 1/2" deep; 19 1/4" wide; 15 3/4" high.....NET \$29.95

IMMEDIATE DELIVERY: The extensive engineering and manufacturing facilities of Transvision facilitate prompt shipment of all orders.

See your local distributor, or for further information write to:

TRANSVISION, INC. Dept. R.C.
385 North Ave. New Rochelle, N. Y.

TRY THIS ONE

MOUNTING CRYSTAL DIODES

A very convenient method of mounting crystal diodes such as the 1N21, 1N23, etc., firmly in place without further support can be improvised with a grid clip and a wafer socket terminal. The grid clip is placed over the large end of the crystal and the small end inserted in the pin terminal.

This method may be used to advantage when building such sets as the

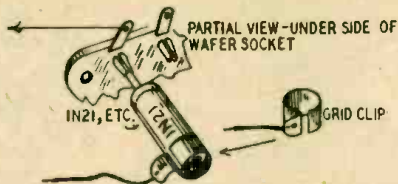

Megadyne which use a crystal detector with a vacuum tube. The diode may be inserted in an unused socket terminal and the rest of the terminals used for tube connections.

WALTER J. BLAZEK,
Brooklyn, N. Y.

(The same system can be used when adding crystal-diode noise limiters, a.v.c. rectifiers, and other refinements to radios and amplifiers.—Editor)

EXPERIMENTAL SOCKET

From time to time every experimenter has desired a simple and effective way to make temporary setups using vacuum tubes. The socket shown makes this possible. A regular 4-, 5- or 8-pin socket is mounted on a piece of bakelite or similar material, about 2 1/4 inches in diameter, employing the metal mounting flange supplied with it.

A socket hole is cut in a piece of 1/4-inch bakelite and studs are mounted to serve as binding posts. The socket is mounted in the hole and the socket lugs bent flat against the bottom of the socket. The binding posts have been re-

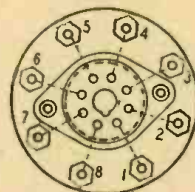

The experimental socket, top and side view.

cessed to allow the bottom cover plate to be mounted flush against the upper piece. Wires connecting the socket terminals and the studs are sandwiched between the 2 pieces of bakelite. The studs are numbered to correspond to the tube pin numbers.

The nuts for the 2 bolts which hold the assembly together are recessed in the bottom plate to make a neat unit.

EDWARD F. ZIEMENDORF,
Niagara Falls, N. Y.

HANDY CRYSTAL HOLDER

When grinding crystal blanks to a specified frequency, it is desirable to check the frequency readily and easily. Instead of using a regular holder for testing them, I use one made from two

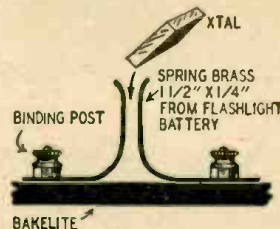

1 1/2 x 1/4-inch spring brass strips and a piece of bakelite or other insulating material. Two binding posts are used for connecting into the circuit. To use, just slide the crystal between the strips so that the contact points are in the center of the blank.

D. STAPLETON,
Grahamstown, South Africa

SIMPLE TESTER

When servicing farm and automobile radios, I use this simple meter for reading the output voltage of the storage battery and the amount of current

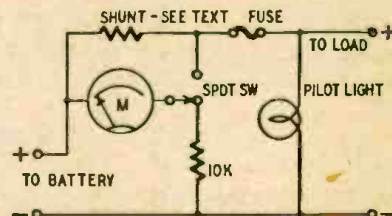

drawn by the set. The entire unit is built in a 3-inch meter case.

I use a 3-inch, 100-ma, d.c. meter with a 10-ampere shunt or 10-volt multiplier that can be selected with a s.p.d.t. switch. The shunt is wound with No. 12 wire and the multiplier is a 10,000-ohm resistor.

EDWARD L. SPEAR,
South Park, Maine

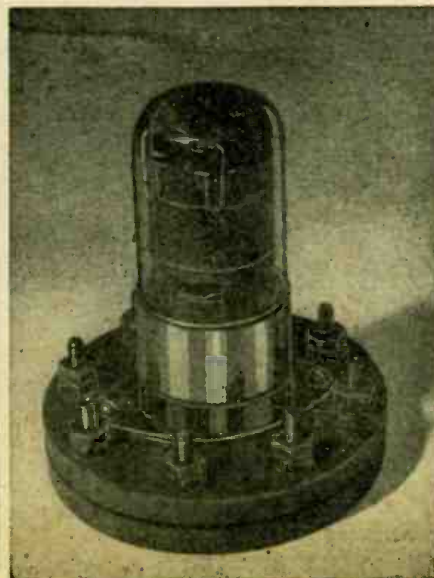

GENERAL ELECTRIC RT-1248 15-TUBE TRANSMITTER-RECEIVER

TERRIFIC POWER—(20 watts) on any two instantly selected, easily pre-adjusted frequencies from 435 to 500 Mc. Transmitter uses 5 tubes including a Western Electric 316 A as final. Receiver uses 10 tubes including 955's, as first detector and oscillator, and 3-7H7's as IF's, with 4 slug-tuned 40 Mc. IF transformers, plus a 7H7, 7E6's and 7F7's. In addition unit contains 8 relays designed to operate any sort of external equipment when actuated by a received signal from a similar set elsewhere. Originally designed for 12 volt operation, power supply is not included, as it is a cinch for any amateur to connect this unit for 110V AC, using any supply capable of 400V DC at 135 MA. The ideal unit for use in mobile or stationary service in the Citizen's Radio Telephone Band where no license is necessary. Instructions and diagrams supplied for running the RT-1248 transmitter on either code or voice, in AM or FM transmission or reception, for use as a mobile public address system, as an 80 to 110 Mc. FM broadcast receiver, as a Facsimile transmitter or receiver, as an amateur television transmitter or receiver, for remote control relay hook-ups, for Geiger-Mueller counter applications. It sells for only \$29.95 or two for \$53.90. If desired for marine or mobile use, the dynamotor which will work on either 12 or 24V DC and supply all power for the set is only \$15.00 additional.

ARMY BC-312 COMMUNICATIONS RECEIVER

This receiver covers the frequency range of 1.5 MC to 18 MC in six direct reading bands. The dial, that is driven with split gears to prevent backlash, has 4500 logging divisions per band with approximately 600 divisions on the 20 and 40 meter ham bands and 1000 divisions on 80 meters. Two stages of RF before the converter in this set give it a very high signal to noise ratio and maximum sensitivity. Outstanding features of this receiver are: BFO with pitch control, send-receive relay, jacks on the front panel for headphones and speaker output, and mike and key inputs. All tubes are standard 6 volt types. This receiver was designed to withstand rough usage in the field and for operation from vehicles while in motion, so it is ruggedly constructed and contains a dynamotor power supply—Your cost—\$49.95. Conversion kit to 110 VAC is available for ... \$6.50

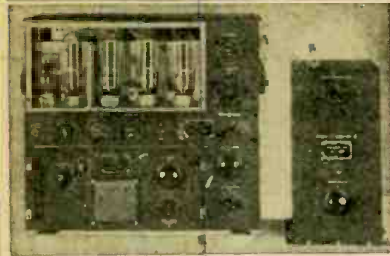

GENERAL ELECTRIC 150 WATT TRANSMITTER

**Cost the Government \$1800.00
Cost to you \$44.50!!!!**

This is the famous transmitter used in U.S. Army bombers and ground stations, during the war. Its design and construction have been proved in service, under all kinds of

conditions, all over the world. The entire frequency range is covered by means of plug-in tuning units which are included. Each tuning unit has its own oscillator and power amplifier coils and condensers, and antenna tuning circuits—all designed to operate at top efficiency within its particular frequency range. Transmitter and accessories are finished in black crackle, and the milliammeter, voltmeter, and RF ammeter are mounted on the front panel. Here are the specifications: **FREQUENCY RANGE:** 200 to 500 KC and 1500 to 12,500 KC. (Will operate on 10 and 20 meter band with slight modification). **OSCILLATOR:** Self-excited, thermo compensated, and hand calibrated. **POWER AMPLIFIER:** Neutralized class "C" stage, using 211 tube, and equipped with antenna coupling circuit which matches practically any length antenna. **MODULATOR:** Class "B"—uses two 211 tubes. **POWER SUPPLY:** Supplied complete with dynamotor which furnishes 1000V at 350 MA. Complete instructions are furnished to operate set from 110V AC. **SIZE:** 21 1/2 x 23 x 9 1/4 inches. Total shipping weight 200 lbs., complete with all tubes, dynamotor power supply, five tuning units, antenna tuning unit and the essential plugs. These units have been removed from unused aircraft but are guaranteed to be in perfect condition.

BENDIX SCR 522—Very High Frequency Voice Transmitter-Receiver—100 to 156 MC. This job was good enough for the Joint Command to make it standard equipment in everything that flew, even though each set cost the Gov't. \$2500.00. Crystal Controlled and Amplitude Modulated—HIGH TRANSMITTER OUTPUT and 3 Microvolt Receiver Sensitivity gave good communication up to 180 miles at high altitudes. Receiver has ten tubes and transmitter has seven tubes, including two 832's. Furnished complete with 17 tubes, remote control unit, 4 crystals, 24 volt dynamotor and the special wide band VHF antenna that was designed for this set. These sets have been removed from unused aircraft and are guaranteed to be in perfect condition. We include free parts and diagrams for the conversion to "continuously-variable frequency coverage" in the receiver. The cost of this unit is only \$37.95.

BRAND NEW 12 VOLT DYNAMOTOR for SCR 522—\$12.00, 24 volt dynamotor—\$6.00. Used SCR 522, less dynamotor, remote control unit and antenna—as is—\$19.95. Wide band VHF antennas—\$1.95.

BC 221 FREQUENCY METERS with calibrating Crystal and calibration charts. A precision frequency standard that is useful for innumerable applications for laboratory technician, service man, amateur, and experimenter, at the give away price of only \$39.95

RELAY BOX BC-616 contains 3 high speed DPDT DC relays, that may be used as keying relays, resistors and a 150 MFD condenser. The aluminum box, with cover, measures 5 1/2 x 6 1/2 x 2 inches. While this terrific bargain lasts—\$1.95.

BC 654 TRANSMITTER-RECEIVER—BRAND NEW with 17 tubes, key, microphone and 200 KC calibrating crystal—\$39.95.

RANGE UNIT RT-1579 consists of a three stage high gain, high fidelity amplifier and a Helmholtz coil for manually introducing phase shift from 0° to 360°. The amplifier is cascade 6SJ7's driving a 6F6 in the output, also on the same chassis is the 110v 60 cycle power supply. The Helmholtz coil is rotated by a vernier drive mechanism that has a dial that contains 4000 1/4 inch divisions. Your cost—\$14.95.

BRAND NEW BC 348 COMMUNICATIONS RECEIVER

Featuring coverage from 200 to 500 Kc. and 1500 to 18,000 Kc on a direct reading dial with the finest vernier drive to be found on any radio at any price—high sensitivity with a high degree of stability—crystal filter—BFO with pitch control—standard 6 volt tubes. Contains a plate supply dynamotor in a compartment within the black crackle finished cabinet, the removal of the dynamotor leaves plenty of room for the installation of a 110V, 25 or 60 cycle power supply. These receivers, which make any civilian communications receiver priced under \$200.00 look cheap and shabby by comparison, are only \$69.95 brand new. Power supply kit for conversion to 110V 25 or 60 cycles, is only \$8.50 additional. Minimum order \$3.00 — All prices subject to change — 25% deposit with COD orders

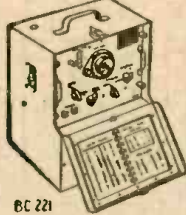

BC 221

SERVICEMEN

Check This Column for Lowest Prices on Quality Parts

TUBES: all types in stock, 60% off on all tubes if ordered in lots of 10 or more.

TRANSFORMERS—All types in stock. **AUTO-TRANSFORMERS:** Steps up 110v to 220v, or steps down 220v to 110v—\$1.95. **FIL. TRANS.:** 6.3v, 8 Amps.—\$1.95; 6v, 10 Amps.—\$1.95; Universal Output Trans. 5 Watt—89c; 18 Watt—\$1.29; 30 Watt—\$1.69.

AUDIO TRANSFORMERS: S. Plate to S. Grid. 3:1—79c; S. Plate to P.P. Grids—79c; Heavy Duty Class AB or B. P.P. Inputs—\$1.49; Midzest Output for AO-DC sets—69c; **MIKE TRANSFORMER** for T-17 Shure microphone, similar to UTC cancer type—\$2.00. Stancor SB or DB mike to line or grid—\$1.95.

POWER TRANSFORMERS—Half-shell type, 110V, 60 cy. Center-tapped HV winding. Specify either 2.5 or 6.3V filament when ordering.

For 4-5 tube sets—650V, 40MA. 5V & 2.5 or 6.3V.....\$1.49
For 5-6 tube sets—650V, 45MA. 5V & 2.5 or 6.3V.....1.75
For 6-7 tube sets—675V, 50MA. 5V & 2.5 or 6.3V.....1.90
For 7-8 tube sets—700V, 70MA. 5V & 6.3 or two 2.5V.....2.35
For 8-9 tube sets—700V-90MA. 5V-8A. 2.5V-3.5A.....2.85
For 9-11 tube sets—700V, 100MA. 5V & 6.3V-1A.....2.85
For 9-15 tube sets—800V, 150MA. 5V & 6.3V.....2.95

CONDENSERS—PAPER TUBULAR 600 WV—001, .002, .005—8c; .01, .05—9c; .1—10c; .25—23c; .5—36c; **ELECTROLYTICS:** 8mfd 200v—20c; 10mfd 35v—20c; 30mfd 150v—23c; 20/20mfd 150v—35c; 30/20 150v—46c; 50mfd 150v—43c; 8mfd 475v—34c; 16mfd 350v—65c; **OIL CONDENSERS:** 4mfd 600v 49c; **BATH TUB TYPE CONDENSERS:** 3X.1mfd—20c; **RESISTORS:** All types in stock at the lowest prices; Resistor Kits: 100 2 watt resistors—\$1.95.

FILTER CHOKES: 200, 300, 400, 500 ohm light duty—59c; 200 or 300 ohm heavy duty—99c; 250 ma 35 ohm, made for U.S. Navy, fully shielded—\$1.95; 75 ohm 125 ma—25c or 25 for \$4.25; "Melsner type" tapped filter chokes—25c; 8 amp. iron core A filter—25c; Choke-condenser combination, ideal to replace any size speaker field when installing PM speakers—79c.

110 V. CIRCUIT BREAKERS of Magnetite type: Following Current Ratings in Block: 1.25, 3, 4, 8 Amps. Please specify. \$1.95 each. Seven Assorted I.F. Transformers—\$1.98; Five Ass'd. Oscillator Coils—69c.

SPEAKERS—PM dynamic type—4"—\$1.55; 5" \$1.55; 6"—\$1.95; 8"—\$3.95; 10"—\$5.95; 12"—\$7.50.

HEADPHONES—Highest quality Siskal Corps headsets with 12" cord and plug \$1.25. 5" rubber covered DeArbords with phone plug and socket—45c.

SELENIUM RECTIFIERS—Dry disc type 1 1/2" by 1 1/2" 1.2 Amp. maximum suitable for converting DC relays to AC for supplying filament source in portable radios, converting DC meters to AC applications, and also may be used in low current chargers—90c.

METER RECTIFIERS—Full wave, may be used for replacement, or in construction of all types of test equipment—\$1.25. Half Wave—90c.

LINE FILTERS—110V—each unit contains two 2 mfd. oil filled condensers and a 15 amp. iron core choke. This filter has innumerable uses such as oil burner line filter, etc. A ten dollar value for 98c. Crystal pick-up, phono motor and turntable—\$5.25.

WILLARD rechargeable 32 storage batteries for portable radios or any other purpose—\$2.95.

PUBLIC ADDRESS AMPLIFIERS—25 watts peak output. This unit has separate input circuits for microphone and phone. The gain of the microphone circuit is 122db. The phono circuit has a gain of 82db. The frequency response is flat from 50 to 12,000 cycles. A \$65 value for only \$32.

Miniature pliers set contains one of each of the following: Needle nose, flat nose, parrot nose, standard nose. All contained in a leatherette case. Your cost—\$1.98.

ATR battery eliminator—Handy for servicing car radios or any other purpose requiring 6 or 12v at 14 amps. Net price—\$36. **SOCKET WRENCH SET** consisting of 5 sockets ranging in size from 5/16 to 1/2" and a handle—79c.

AUTOMATIC WIRE STRIPPERS will strip up to 1000 wires per hour, a handy tool for any service job—\$3.52. Six Foot Asbestos Insulated Flat Iron Cord, one end has a male plug, the other end has a standard flat iron socket. Your price—70c each or 10 for \$5.

FREE!!!! THIS MONTH ONLY

A HIGH GRADE CRYSTAL PICK-UP WITH THE PURCHASE OF EACH PHONO MOTOR AT \$4.95.



MICROPHONES—All nationally known brands. Bullitt crystal—\$5.45; Bullitt Dynamic—\$7.45; Mike Jr.—60c; Handy Mike—90c; Lapel Mike—95c; SHURE T-17 MIKES, with push to talk switch—99c.

20 ASST'D COIL FORMS, including 11 ceramic, 3 polystyrene, and 6 fiber. All useful sizes—50c.

VARIABLE CONDENSERS: 350 MMFD, 5 gang—\$1.95; 4 gang—\$1.49; 3 gang—83c; 2 gang—79c; 7.5 to 20 MMFD, 1750v spacing, extra long shaft Hammarlund—69c; miniature variables, 25 MMFD—39c; 50 MMFD—49c; 75 MMFD—59c; 100 MMFD—69c; 140 MMFD—79c.

TRANSMITTING RF CHOKES, 4 PIE, 350 Ma.—25c or 5 for \$1.00.

INTERRUPTION FREQUENCY COILS for super-regenerative receivers or the tremendously popular FM adapters for standard broadcast sets. Iron core with a resonant frequency of 50 KC—39c; Air Core, 100 KC—29c.

30 MC IF TRANSFORMERS, double slug tuned—25c.

VIDEO AMPLIFIER PLATE COILS—Slug tuned—25c. **REMOTE CONTROL UNIT:** Aluminum case 4x3x2" containing 2 potentiometers, triple pole switch, 4 knobs, rear mechanism, counter and phono jacks—59c.

MODULATION TRANSFORMERS—10 watt, metal case 98c; 30 watt, open-type, \$1.95; 40 watt, cast aluminum case, \$2.95; Class "B" input transformers, cast aluminum case, \$1.95; Transceiver audio transformers, 65c; Transceiver modulation transformers, 65c.



Question Box queries will be answered by mail and those of general interest will be printed in the magazine. A fee of 50c will be charged for simple questions requiring no schematics. Write for estimate on questions that may require diagrams or considerable research.

INTERFERENCE LOCATOR

I live in an area where the noise level is very high and would like to track the interference to its source. Can an all-wave portable be used for this purpose? If so, please print a suitable diagram. I would like to confine the circuit to 4 tubes if possible.—A.W.K., Detroit, Mich.

This circuit of a 4-tube superhet is designed to cover from 540 kc to about 18 mc, depending on the coils used. A special loop antenna is used. It consists of 2 windings. The primary has 30 turns of No. 24 d.c.c. wire wound in the form of a loop 8 inches in diameter and tapped at the center. The secondary, 3 turns of No. 24 d.c.c. wound around the primary, connects to X and Y on the receiver. The antenna range switch and tuning condenser should be mounted on top of the receiver cabinet so that they can be reached conveniently while walking with the set. It may be mounted in a standard portable cabinet.

To operate the locator, tune the set to a frequency where the noise is strongest. Rotate the set for maximum noise pickup. Maximum noise will be picked up when the plane of the loop is pointing toward the source of interference. By moving along the plane of the loop several hundred feet, it should be possible to locate the general area of the noise source.

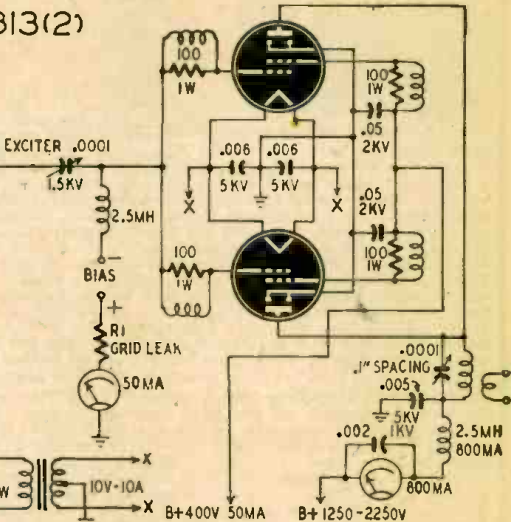
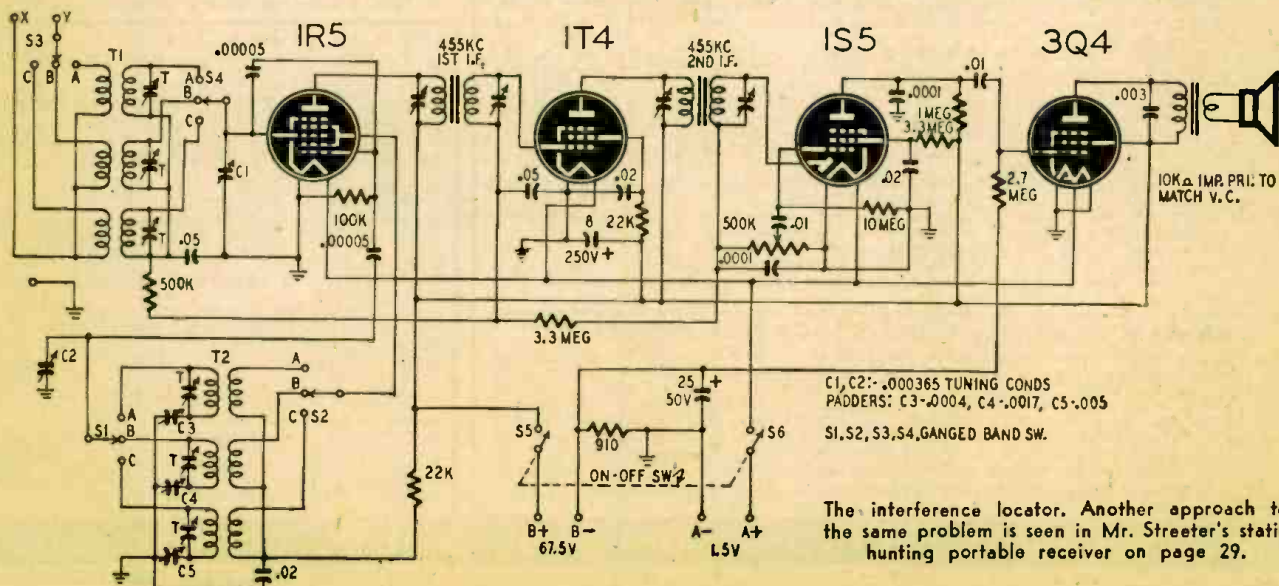

Parallel operation of beam-power tubes provides stability.

POWER AMPLIFIER

I would like to have a circuit of a final amplifier for a transmitter using parallel 813's. This stage is to be capacity-coupled to a driver stage. Fixed bias must be used, since I plan to key the oscillator. The transmitter is to be c.w. operated on the 80- and 40-meter bands.—T.E.D., Lansing, Mich.

The circuit you request is shown. Parasitic suppressors are inserted in the control and screen grid circuits. Each suppressor consists of 6 turns of No. 16 enamel wire wound around a 100-ohm, 1-watt carbon resistor. The 400 volts for the screen grids should be obtained from a separate supply or from a bleeder across the power supply.

The value of the grid leak and the fixed bias voltage will depend on the plate voltage used. For 1,250 volts on the plate, use 22.5 volts bias and a 1,500-ohm resistor; for 1,500 volts use 2,400 ohms and 45 volts and for 2,000 volts use 3,000 ohms and 45 volts.

Screen-grid or plate modulation may be used. For plate-screen modulation,

it is advisable to use a dropping resistor to get normal screen voltage from modulated plate supply. Use by-pass condensers of .002 μ f or less. Plate condenser spacing allows plate modulation at maximum permissible input.

The sockets of the 813's should be submounted so that the internal plate shield is level with the chassis. The plate coils of the exciter should be mounted under the chassis or shielded to prevent oscillations.

NOW YOU TOO CAN BUILD 15 RADIOS

COMPLETE
KIT ONLY

\$14.⁷⁵



**ABSOLUTELY NO KNOWLEDGE OF RADIO NECESSARY
YOU NEED NO ADDITIONAL PARTS!**

THE PROGRESSIVE RADIO KIT is THE ONLY COMPLETE KIT. Contains everything you need. Instruction Book, Metal Chassis, Tubes, Condensers, Resistors and all Radio parts. The 36-Page Book written by Expert Radio Instructors teaches you to build radios in a Professional Manner. You start with two 1-tube receivers. Then you will build three 2-tube receivers. You will continue by building six 3-tube receivers. You will then make a 3-tube public address system which will permit you to address large audiences. Finally you will build three different 3-tube transmitters

so that you can get a real thrill out of being "on the air." Before you are done with this kit, you will have built 11 Receivers, 1 Public Address System and 3 Transmitters.

RADIO PARTS SCOOP!

NO SURPLUS — ALL PARTS
GUARANTEED BRAND NEW!



SPEAKERS
6-INCH PM ALNICO V
SPEAKERS

\$1.⁶⁹

CONDENSERS

DUAL 20/20 MFD ELEC-
TROLYTIC CONDENSERS
150 V.D.C.

29c

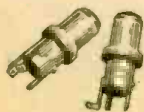

COILS
MATCHED ANTENNA
AND RF COILS FOR
BROADCAST BAND
SET:

53c

RECTIFIERS

SELENIUM
RECTIFIERS

79c



SPECIAL FREE OFFER!

Electrical and Radio Tester sent absolutely FREE with each Progressive Radio Kit. PLUS FREE membership in Progressive Radio Club. Entitles you to free expert advice and consultation service with licensed radio technicians. Write for further information, or ORDER your KIT NOW!

MAIL COUPON TODAY!

PROGRESSIVE ELECTRONICS CO., Dept. FP-1
22 HAVEMEYER STREET, BROOKLYN 11, NEW YORK

SIRS: Please send me the following:

- Progressive Radio Kit Complete\$14.75
- 6" Alnico V Speakers (\$1.69 each)
- Electrolytic condensers (29c each)
- Sets Antenna & RF coils (53c per set)
- Selenium Rectifiers (79c each)
- Enclosed find check or money order (Postage Prepaid) TOTAL
- SEND C.O.D. (I will pay postage)

NAME

ADDRESS

CITY

ZONE

STATE

Send additional information on Radio Kit.

McMurdo Silver
AM - FM
906 SIGNAL GENERATOR



AVAILABLE NOW

WHAT AN INSTRUMENT:
90 kc. through 170 mc. on fundamentals . . . 8 air-
trimmed bands . . . variable % 400 — amplitude
modulation . . . built-in variable electronic FM sweep
laboratory triply adjustable attenuator . . . me-
tered microvolts . . . output 1/2 microvolt to over 1
volt . . . multiply shielded . . . strays
lower than \$500.00 laboratory gen- **\$89.90** Net
ctors! Yet all this costs you only . . . Complete stock of Radio Equipment & Parts. All
shipments made within 4 hours of receipt.

Mission Radio Inc.

816 S. Presa Street San Antonio, Texas

Amazing! POCKET OR PURSE SIZE
NEW RADIO

WORLD'S SMALLEST RADIO KNOWN!
Wt. only 1/2 lb. Beautiful Silver Black plastic
case. Has Inductive Slide Tuner—24 Crystal
Diode—NO TUBES, BATTERIES OR ELECTRIC
"PLUG IN" NEEDED! Should last for years!

GUARANTEED TO PLAY NEW 1948 MODEL
on local stations if complete instructions sent
are followed. Use it at home, in bed, in many offices, hotels, cabins—most any-
where! HUNDREDS OF SATISFIED CUSTOMERS ALL OVER THE WORLD!
SEND ONLY \$1.00 (Cash, M.O. Check) and pay postman \$2.99 plus de-
livery. Every set on arrival or send \$3.99 for Post Paid
delivery. Complete as shown—ready to play with self contained personal phone.
WONDERFUL GIFTS FOR CHILDREN! Order now at this low bargain price—
Prompt shipment on orders sent now—today! Be the first to get YOUR Pocket-
Radio! (All foreign orders \$5.00 U. S. cash with order).
Pa-Kette Radio Co., Inc. Dept. RC-9 Kearney, Nebr.

Make Your Own Records



with Risco 3-way
Home Recorder
4 1/2 Minutes Re-
cording on a 10"
Record
10 minutes dual
speed
Ready to operate
with 6" Spkr.,
Crystal Mike
\$49.50
\$5 extra for dual
speed

Walnut cabinet or portable case

1. Ideal for music lessons, parties, your child's cute sayings, etc.
2. High quality phonograph play-back reproduction.
3. High output for a public address.

25% on C.O.D. Orders—Free Catalog—Complete Details
WHOLESALE DISTRIBUTORS—VISIT OUR SHOWROOM

RISCO ELECTRONICS

22 Warren St. Tel. BE 3-8554 N. Y. 7, N. Y.

See CANNON-BALL HEARING AID for Radio Reception



Easily attached to any Radio for private reception with or without loud speaker. Write

C. F. CANNON CO.
SPRINGWATER, N. Y.

Headset Headquarters

TUBE CHECKER

Here is a kink that I have found useful in finding intermittent opens in glass and metal radio tubes. Usually these conditions do not show up in tube checkers or ohmmeters, so I put them under actual line conditions. The suspected tube is connected in series with the 117-volt line and a suitable light bulb that acts as a dropping resistor.

Bulb sizes may be found by Ohm's law: watts equals volts multiplied by amperes. For example: A 12A7 is suspected. The voltage drop across the bulb is equal 117 volts (line voltage) minus 12.6 volts (filament voltage), which equals 104.4 volts. Multiplying this value by 0.3 ampere shows a 31.32-watt bulb to be the ideal resistor. In practice, a 30- or 40-watt lamp may be used. The former lamp passes 0.287 ampere and the latter 0.383 ampere. The 40-watt lamp is preferred for this purpose.

JIM COATES, W6VYB,
Harbor City, Calif.

The Port of Liverpool, (England) is installing radar equipment, which will scan its harbor and 12-mile approach channel continuously during foggy weather. All harbor pilots, inward and outward bound, will carry portable radio sets with which they will remain in constant contact with the shore radar station. Thus they can receive instructions to aid them in avoiding collisions and navigating in fog.

YOUR RADIO STORE

OLSON

OLSON RADIO WAREHOUSE, INC. AKRON 8, O.

NEW! OLSON "AKRAD" CONDENSER

FREE YOUR RADIO FROM HUM!

SEPARATORS Highest purity cathodes, loaded with dry paste. Electrolyte.

LEADS Will not corrode or break.

WHAT IS AN ELECTROLYTIC CONDENSER?

BEAUTY TUBE Fine finish with spun ends insulates, protects and identifies over OLSON "Akrad" Condenser.

BEAL TUBE Alum. in a shell, hermetically sealed to withstand moisture and shock.

OLSON "AKRAD" CONDENSER D. 8 v. 450V

NEW Comic Poster FREE!

TO DISPLAY IN YOUR WINDOW:
Another OLSON crowd-puller! Get this new giant-size Window Poster absolutely FREE, postpaid, just by sending the coupon below. Actual size of Poster, 17" x 22". It explains in pictures and easy-to-understand words how Electrolytic Condensers work. The upper half is a large diagram showing the parts of a Condenser, and the lower half has five big, amusing cartoons comparing the Condenser with a cheese sandwich and the corroding agent as a mouse. People will STOP and look at this swell Poster in your window or Service Dept. Along with the Poster you get a FREE CATALOG listing Olson's famous Radio Parts at prices that will save you plenty!

PASTE THIS COUPON ON A POSTCARD AND MAIL TODAY

OLSON RADIO WAREHOUSE

73 E. MILL ST., DEPT. 95, AKRON, OHIO

Yes sir! Send me the New Comic Poster free.

NAME _____
COMPANY _____
ADDRESS _____
CITY _____ STATE _____

ACTUAL POSTER HAS 5 CARTOONS
THESE TWO ARE ENLARGED TO SHOW DETAIL

Condensers made by cheaper methods and with poor materials "short out," a process which can be compared to a mouse eating out the cheese from our cheese sandwich.

But in the Olson "Akrad" Condenser sandwich, the "mouse" or corroding agent finds the going tough and he retreats in defeat, leaving the Condenser intact.

Start Your Own RADIO SERVICE SHOP

Choose one of these
3 GREAT NEW DEALS

\$99⁵⁰

\$179⁵⁰

\$350⁰⁰

Includes TEST EQUIPMENT, TUBES, PARTS, TOOLS

3 complete going-in-business packages. (If necessary they can be changed to suit your needs.)

There never was a better opportunity than now to start a profitable business of your own. No fuss, no worry. Here's everything you need. Details upon request. Write, wire or phone!

Featherweight Miniature TEST INSTRUMENTS

Compact — Accurate — Priced Right!

- Jeweled Meter • Range Selector Switch
- All multipliers bridge tested for 1% accuracy
- Zero adjustment—built in batteries
- Molded bakelite case only 3-15/16" x 2-7/8" x 2"

MODEL 451A AC-DC Volt—Ohm—Milliammeter



A dependable instrument of wide utility—sensitivity 1000 ohms per volt. Ranges: Volts AC, DC, and Output Ranges. 0-10/50/100/500/1000; Ohms full scale, 500,000. Ohms center scale, 7200.

NET complete with batteries..... **14⁹⁰**

MODEL 312 Volt—Ohm—Milliammeter



An economy, pocket meter featuring a 2" moving vane meter. Reads: AC-DC volts, 0-25/50/125/250; Mills AC-DC, 0-50; Ohms, 100,000; mid. .05-15. Jacks provide range selection.

NET Complete with cord and plug..... **675**

Triplet FAMOUS "LITTLE TRIPLETT'S"
The Little Testers with the big 3" Meters Bakelite cases 3 1/4" x 5 3/8" x 2 1/2". Range selection switch—long, easy to read scales. We made a good buy—here they are at rock-bottom prices—The greatest buy ever offered in precision testing equipment.

Model 650SC - OUTPUT METER



A 4000 ohm constant impedance AC volt meter with ranges of 0-1.5-6-15-60-150 volts. Conversion chart for reading DB level from -10DB to +35 DB. 100 microampere meter. Excellent for receiver alignment, level indicators in recording equipment, general use on electronic apparatus. Regular net 24.50. A "one time only" Special buy at..... **1049**

Model 606B-VOLTAGE TESTER



Checks voltage and polarity. Range: 0-440 AC-DC volts—definite indications for 115, 220, and 440 volt lines. Separate polarized vane for AC or DC indication. Built in test leads. Excellent for checking wiring, fuses, general factory installation and maintenance. Every plant — every electrician needs several at this low price. Regular net 16.67. Special at..... **8⁹⁵**

RADIART AERIALS

The Quality leader — Recognized by everyone • Admiralty brass rods • Triple plated • Permanently rattle proof. • Static muffler ball • Polyethylene insulated HI Q lead with protective vinylite covering • Supplied with single pin (Motorola) connector and adaptor for bayonet style (Delco and Philco) fittings.



TYPE CF3-63

A two insulator side cowl mount—3 section 63" rod—supplied with 3 insulators and wedge adaptor to fit 95% of all car bodies—complete with 48" lead. **1⁹⁹**
List price \$4.95—our price.....



TYPE CFA3-63

All angle cowl or fender mount—A modern Radiart development—fits all body contours, straight or curved, cowl or fender. 3 section 63" rod easily adjusted to vertical without tools—complete with 40" lead. **1⁹⁹**
List price \$5.45 we sell for.....

GENERATOR CONDENSERS

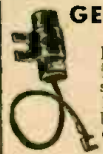

PHILCO part No. 61-0177—5 mfd.—3/8" x 1 1/2"—4" lead-slotted mounting strap for easy installation—Standard Merchandise—not war surplus—Present list price \$1.00. Our special—over 85% off..... **14c**

200 WATT SOLDERING IRON FAMOUS HEXACON ELECTRIC'S MODEL 201



FEATURES: Full 200 watt replaceable element. 3/8" tinned Copper tip, replaceable. One piece drawn case-gun metal finish. 6" heavy duty cord—stand included. Comfortable, well balanced handle. Operates on 110 volts—AC or DC. **List Price \$8.00** Speed up your heavy work—Save time—save money at..... **3⁶⁹**

OUTPUT TRANSFORMERS

Clean stocks — long leads — mounting feet — made to fit where you need them. For 6FG-6KG—to 4 ohm voice coil—size 2" x 1 1/4" x 1 3/4". 50L6-35L6-25L6 to 4 ohm voice coil 1 1/4" x 1 3/4" x 1 3/4". Specify quantity of each type you need at..... **49c**

Order from the Ad
Write - Wire - Phone

PHONO PICKUP CRYSTALS

Standard types—Set Manufacturers close-out—all Guaranteed



Webster F2—Replaces L26-L40-L70 etc.—pin type terminals—1 oz. pressure—1 volt output—5000 cycle cutoff. List price \$5.00—you pay us..... **149**



SHURE P93—W57A—pin type terminals—3/4 oz. pressure—1.6 volt output—6000 cycle cut off. List price \$4.45—our Special..... **198**



Astatic L-70—new postwar design—solder terminals—1 1/4 oz. pressure—1 volt output—4000 cycle cutoff. List price \$5.55—we quote you..... **198**

PHILCO BEAM OF LIGHT

Selenium cell only, no holder, postpaid... (Puts new life into Philco Changers) **180**
Sapphire needle only, no mirror, postpaid..... **120**

ALL RUBBER LAMP CORD



Underwriters Approved brown rubber covered insulated parallel Cord—"zips" apart easily—non fraying—deluxe—way above average quality. 500' Roll..... **989**

MULTI-USE WIRE



Stranded No. 22 tinned wire—glass "ROCKBESTOS" 1000 volt insulation—fireproof aircraft wire—a wartime development—at this low price you can use the best—

100 feet..... **45c** 1000 feet..... **389**

JEWELLED PILOT LIGHT ASSEMBLIES



- Candela screw base for 110 volt lamp.
- Mount in 1" hole.
- Lamps removable from front of panel.
- Available marked 1-2-3 or 4 on back of white lens.

YOUR CHOICE net..... **19c**

Include full remittance with orders of \$3.00 or less. Include 25% deposit with all C.O.D. orders of \$3.00 or more. Prices subject to change without notice.

SEND FOR FREE CATALOG

RADIO SUPPLY & ENGINEERING CO., Inc.

125 SELDEN AVE. DETROIT 1, MICH.

use... OHMITE

Replacements

BROWN DEVIL RESISTORS... Wire-wound, vitreous-enameled type. Now in compact 5-watt size. Also 10 and 20-watt units.

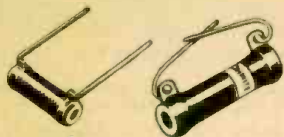

LITTLE DEVIL RESISTORS... Now 1/2 and 1-watt sizes in $\pm 5\%$ tolerances. Also 1/2, 1, and 2-watt sizes in $\pm 10\%$ tolerances.

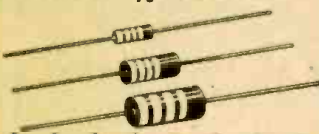

TYPE AB POTENTIOMETER... A new extremely high quality molded composition unit—rated 2 watts with a good margin of safety.

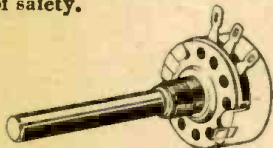

DIVIDOHM ADJUSTABLE RESISTORS... Wire-wound vitreous-enameled type—10 to 200 watts. Sturdy... dependable.

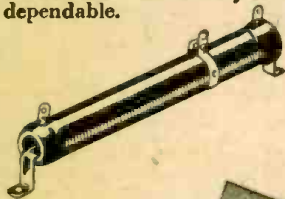

See Your Nearest
Ohmite
Distributor
Send for
Catalog 19

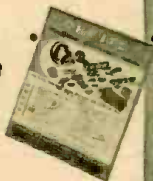

OHMITE MANUFACTURING CO.
4895 Flournoy St., Chicago

Be Right with...

OHMITE
RHEOSTATS • RESISTORS
TAP SWITCHES

WORLD-WIDE STATION LIST

Edited by ELMER R. FULLER

If the reports received are any indication of conditions, reception must have been very poor during the past month. Several reports were received, but nothing unusual seems to have been heard by any of our observers. Reports were sent to us by Bill Duggan of Goshen, New York. He was recently separated from the Navy and we wish to welcome him back to our ranks. Bill sent us many fine reports on overseas stations when he was in Europe, Africa, and Asia. Now we hope to have some fine reports from him at home in Goshen. Other reports were received from the Canadian Broadcasting Corporation; Bill Cooley of Fairchance, Pennsylvania; Gerald Nankervis of Westminster, California; Charles S. Sutton of Toledo, Ohio; Radio Station HCJB of Quito, Ecuador; Gilbert Harris of North Adams, Massachusetts; Joseph

Rich of Bronx, New York; and Robert Wagner of Dallas, Texas.

VQ7LO in Kenya is heard with fair signals at 0700 on 4.95 mc with the news at 0700 and 0800. OLR2A in Prague is heard with the news in English at 0915 on 6.01 mc. VLR2 in Sydney is heard from 0230 to 0830 on 6.15 mc with good signals. A good catch is Noumea, New Caledonia on 6.16 mc from 1900 to 2000. TGWA in Guatemala City is heard with very good signals on 6.4 mc during the evening with sign-off at 2315. YNDG in Nicaragua is heard very well until sign off at 2015 on 7.66 mc.

KZRH in the Philippines is heard with the news at 0530, 0730, 0900, 1715, 2300 and 2345 on 9.64 mc. XNAG in Nanking, China is heard from 0525 to 0630 on 11.29 mc. with all announcements in Chinese.

All schedules Eastern Standard Time.

Freq.	Station	Location and Schedule	Freq.	Station	Location and Schedule
7.210	FGY	DAKAR, FRENCH WEST AFRICA	9.340	HLB	GENEVA, SWITZERLAND; 1800 to 1500
7.210	VLQ2	BRISBANE, AUSTRALIA; 0230 to 0830	9.440	FZI	BRAZZAVILLE, FRENCH EQUATORIAL AFRICA; 0000 to 0130; 1100 to 2020
7.220	JCKW	JERUSALEM, PALESTINE; 2330 to 0130	9.460	TAP	ANKARA, TURKEY; 1000 to 1615
7.220	GSW	SINGAPORE, MALAYA; 2330 to 0130	9.470	CR6RA	LOUANDA, ANGOLA; 0115 to 0230; 0630 to 0745; 1400 to 1530
7.230	VLQ	LONDON, ENGLAND; 0100 to 0115; 0130 to 0330; 0600 to 0645; 0700 to 0730; 0745 to 0900; 1045 to 1130; 1230 to 1430; 1530 to 1715	9.480		MOSCOW, U.S.S.R.; 1500 to 1700; 1830 to 2100; 0000 to 0100; 0530 to 0815; 1100 to 1180
7.240	VLQ	BRISBANE, AUSTRALIA; 1500 to 1900	9.500	XEW	MEXICO CITY, MEXICO; 0800 to 0200
7.250	PJCI	WILLEMSTAD, CURACAO; 1130 to 1230; 1630 to 2130	9.500	OIX2	LAHTI, FINLAND; 1100 to 1600
7.250	GW1	LONDON, ENGLAND	9.510	JLG2	TOKYO, JAPAN; 0300 to 0830
7.260	GSU	LONDON, ENGLAND; 2345 to 2400; 0030 to 0200; 0630 to 0645; 0700 to 0800; 0815 to 0900; 1045 to 1300; 1330 to 1700	9.520	VLW7	PERTH, AUSTRALIA; 0530 to 1030; 1700 to 2045
7.260	JVW	TOKYO, JAPAN; 1500 to 0830	9.520	ZRG	JOHANNESBURG, SOUTH AFRICA; 0300 to 0700
7.270	VUD8	DELHI, INDIA; 0600 to 0700; 1115 to 1315; 1830 to 1915; 2100 to 2200	9.520	OZF	COPENHAGEN, DENMARK; 1330 to 1800
7.280	VLC8	SHEPPARTON, AUSTRALIA; 1015 to 1045	9.520	JLU2	TOKYO JAPAN; 0600 to 1200
7.280	JLW	TOKYO, JAPAN; 0200 to 0800			(Continued on page 57)
7.290	VUD3	DELHI, INDIA; 2040 to 2245			
7.290	ZOY	ACCRA, GOLD COAST; 1045 to 1300			
7.290		ATHENS, GREECE; 1430 to 1530			
7.300		MOSCOW, U.S.S.R.; 1300 to 1800; 1815 to 2100			
7.310	YSN	SAN SALVADOR, SALVADOR; 1300 to 1500; 1900 to 2300			
7.320	GRJ	LONDON, ENGLAND; 0000 to 0015; 0645 to 0700; 1045 to 1815			
7.380	HEK3	BERNE, SWITZERLAND; 1000 to 1045; 1510 to 1530			
7.570	EAJ43	SANTA CRUZ, CANARY ISLANDS; 0630 to 0800; 1100 to 1200; 1230 to 1800			
7.640	KU5Q	GUAM; 0400 to 1200			
7.850	ZAA	TIRANA, ALBANIA; 1400 to 1800			
7.860	SUX	CAIRO, EGYPT; 1200 to 1600			
7.950		ALICANTE, SPAIN; 0730 to 0930; 1530 to 1800			
8.030	FXE	BEIRUT, LEBANON; 0015 to 0115; 0525 to 0630; 1000 to 1600			
8.560	AFN	MUNICH, GERMANY; 0400 to 1200			
8.700	COCO	HAVANA, CUBA; 0700 to 2330			
8.720	COJK	CAMAGUEY, CUBA; 2000 to 0030			
8.830	COCQ	HAVANA, CUBA; 0530 to 0030			
8.950	COKG	SANTIAGO, CUBA; 1830 to 2325			
9.030	COBZ	HAVANA, CUBA; 0700 to 0100			
9.080	CNR3	RABAT, MOROCCO; 0100 to 0330; 1300 to 1700			
9.120		BALIKPAPAN, BORNEO; 0700 to 0930			
9.160	CR6RB	BENGUELA, ANGOLA; 1330 to 1430			
9.180	HEF4	BERNE, SWITZERLAND			
9.210	HI2G	CIUDAD TRUJILLO, DOMINICAN REPUBLIC; 0530 to 0830; 1300 to 1530; 1700 to 1845; 1930 to 2230			
9.230	COBQ	HAVANA, CUBA; 0800 to 1200; 2000 to 2200			
9.270	COCX	HAVANA, CUBA; 0700 to 0030			
9.360	EAQ	CETINJE, YUGOSLAVIA			
9.370		MADRID, SPAIN; 1500 to 1700; 1830 to 2100			
9.380	COBC	HAVANA, CUBA; 0700 to 2400			
9.380	OTC	LEOPOLDVILLE, BELGIUM CONGO; 0000 to 0200; 1045 to 1800			
9.420		BELGRADE, YUGOSLAVIA; 0000 to 1230; 1630 to 0845; 1000 to 1045; 1110 to 1125			

RADIO TERM ILLUSTRATED

—Suggested by:
Robert Hopkins,
Nelson, B. C.

High Potential!

"TAB"

• NEW GUARANTEED

ELECTRONIC PARTS •

That's A Buy

USED S.C. & NAVY EQUIPMENT "TAB"
GTD I-222 XTAL CALIB SIG-GENERATOR,
FREQ METER, MONITOR, OP 110V/60cy complete
Covers IF ranges FM & TELEVISION,
DUAL OSC. 8to15&45to77mc's; 2nd, 3rd&4th
harmonics usable to 230mc's. Six Tubes micro-
Vermier dial reads 1/10 div. Rugged Design
SPECIAL \$45.00
NAVY SOUND POWERED TELEPHONES... 9.95
SCR 522 COMPRISES BC624&625 RE-
CEIVER TRANSMITTER 100-156mc's
COVERAGE XTAL CONTROL XMTR
MODULATED ISW OUTPT RCVR 10
Tubes, XMTR 7 tubes Complete with
data for Amateur use 18.00
NAVY RBC RECEIVER & to 27 mc's 16 tubes
BEST RCVR MADE SPECIAL 75.00
BC1073A-VHF WAVEMETER SIG-GEN-
ERATOR OP 110VAC, Range 150-210
mc's/19 tubes can be converted to receiver
SPECIAL 24.95
CWS RCVR NEW COMPLETE & Data for
Converting into Ham RCVR 14.50
CW&F3 Coils 5.1-10 or 9.4-16.5mc's 2.70
AIRCRAFT AUTOSYNS AY-1&5/28V/
400cy can be used 24V/60cy used gtd
TWO for 3.95

GE THERMOSTAT adj 70to170°F/250V/25AMP \$3.95
WSTGHSE RECTIFIER FW 12V/2AMP 3.95
WSTGHSE RECTIFIER CT 9V/0.2AMP... 2 for 1.49
IT&T SELENIUM RECT 110VDC/2.6AMP... 5.95
IT&T SEL RECT 68BAVI. FW 85V/2.4AMP... 6.95
IT&T SEL RECT 6.5V/2.2V/1.5AMP 1.49
BLOWER AIR 100curtm 28VDC & AC Inpt... 4.95
BLOWER AIR SAME OPERATES 115VAC/60cy 5.95
VACUUM CONDORS 50MMF/7500V GE 3.95
VACUUM CONDORS 100MMF/7500V GE 4.95
VACUUM CONDORS 50MMF/20000V JEN 6.95
RAYTHEON VOLTAGE REGULATOR
adj V Inpt taps 95to130V/60cy; output
115V/58AMPS one half 1% REGULA-
TION: wt20lbs 6 1/4" H 8 1/4" W Rugged
dsgn SPECIAL 10.95
HVJ-DUTY VOLTAGE REGULATOR
INPUT TAPPED 198to242 Volts 50/60
cy; OUTPT 220 VOLTS/500WATTS: One
Half 1% Regulation—RAYTHEON new
S.C. D'sgn rugged Construction wt 70
lbs. size 18 1/2" L 8" W 9 1/2" H Relay Rack
mtgng SPECIAL 39.95
TRANSTAT 88-132V/18.2AMPS VARIABLE 29.95
WRITE TAB FOR S.C. TECH-MANUALS

WSTGHSE "DB" MTR 3 1/2" SQ B'C-10+6DB.. \$4.95
WSTGHSE 3 1/2" SQ BKL Case 0-1ma RX35... 4.50
DEJUR 2 1/2" B'Case 0-1ma STD SCALE... 2.95
GE RF MTR 2 1/2" B'Case either 1or5AMP... 3.95
WESTON 476 AC 15VOLT MTR 3 1/2" SQ B'Case 4.50
WESTON 506MTR -10plus60B 2 1/2" B'Case... 4.50
GE DW54 MTR -10plus60B 2 1/2" B'Case... 3.95
GE D040/3 1/2" B'C 2.5&25ma 0 ctr Galvo... 3.95
GE DW41 MTR 2000V/1000ohm per V 2 1/2" B'C 5.95
GE A022 MTR 0-150VAC 3 1/2" B'C 4.95
McCLINTOCK 3 1/2" B'C 0-1ma Meter 3.95
WSTGHSE DUAL 200 microma no 0 adj 1.95
WESTON 506 MTR 250ma 2 1/2" B'C 3.25
WSTGHSE 2 1/2" B'C 30VOLTS AIRCRAFT 2.75
SPEECH AMPLIFIER ARTIS COLLINS.
Line carbon or Dyn Mike; Output to PP
class B Grids Chassis includes Inpt transf
& 1st Audio, 6V6 sidetone adj AudioOsc
AMP & Hddphone Jack W15lbs. 7 1/2" L 3 1/2"
5" H less tubes & pwr supply includes In-
structions SPECIAL 4.95
WITH TWO 6V6 & 6SJ7 7.49
GE Voltage Control Relay PIV/115V/60cy
SP self reset Calib 70/85/110/160V NEW 5.95

NEW GUARANTEED

DYNAMOTORS

S. C., NAVY AIR CORP SPECIF

MODEL 5053

Mfgd A. G. Redmond

W. E. Stern

Electric KS-5868-L03

Input	Output	Duty
28VDC 1.4Amp.	250V 60ma	Continuous

Wgt—2 lbs.

Qty 1800

"TAB" SPECIAL PRICE

\$1.85

Works as 110VDC Motor
Can be used on 12VDC Input by
paralleling field coils.
Air Corps Dy.-2B/ARR-2

★ ★ ★ ★ ★

GENERATOR

MODEL G101

Mfgd Fractiona Motors

Input	Output
3/16 HP Motor RPM 3450	430VDC 180ma
	Duty-Continuous

Dim. 8" L 5" Dia/SHAFT 2 1/2" x 1 1/2" D

Wgt—17 lbs.

QTY 200

"TAB" SPECIAL PRICE

\$8.95

Can be used as DC 110V Motor

ALL BRAND NEW

"TAB" Specially Priced at a Fraction
of Their Original Cost

WRITE FOR QUANTITY PRICES

Can be used as motor or dynamotor

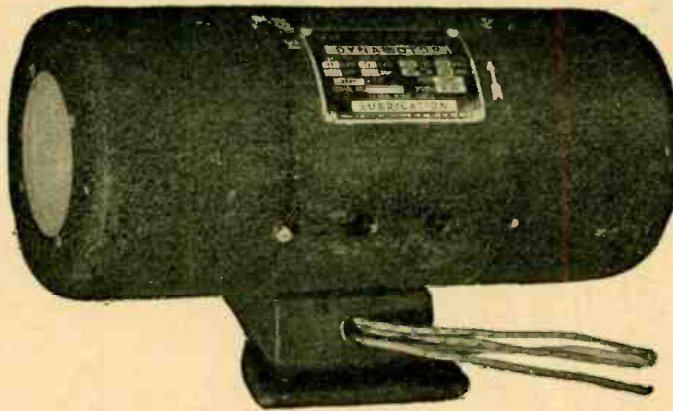

Illustrated Unit
S. C. DM-4 Model D104
Mfgd Fractional Motors

INPUT	RPM	Duty	Output DC
12 or 24 V DC	4000	Continuous	225Volts/100ma 440Volts/200ma

Wgt. 21 lbs. Dim. 11" L 5" Dia. Qty..

"TAB" SPECIAL PRICE
\$6.75

MODEL DA-3A

Mfgd. Bendix & Webster

INPUT	RPM	Duty
28VDC 10.5Amp	4700	Continuous
Output #1	Output #2	Output #3
300VDC 260ma	150VDC 10ma	14.5V 5Amp

Wgt—21 lbs. Dim. 12 1/2" L 5"

Dia., Qty. 1500

"TAB" SPECIAL PRICE

\$3.85

★ ★ ★ ★ ★

MODEL PE-94A

Mfgd Bendix MG-1A

Aircraft Completely Cased
Input & Output Filters, Voltage
Regulators & Relays

Input	RPM	Duty
24-28VDC 13Amps	6000	Cont.
Output #1	Output #2	Output #3
300VDC 260ma	150VDC 10ma	14.5A 5Amp.

Wgt—34 lbs.

Qty. 100

"TAB" SPECIAL PRICE

\$9.95

CHOKE GE 12Hy/300ma cased \$2.95
KENYON CHOKE 20Hy/300ma or 15 Hy/
400 ma Cased 15000V Insulation wt 40 lbs 7.95
CHOKE 20Hy/100ma cased SPECIAL98
STROBO FLASH Transf 1540V/115V/60cy 4.95
HICKOCK 4" SQ Tube Tester Meter 6.95
PRECISION 1% Wire Wound Onemeg resistors
90c @ 3 for 2.00
1.8meg. 2.0, 4.5, 5.0, 10Meg/1% H.V. Six for
WE DYNAMIC MIKE 20 ft CABLE 7.95
8mfd/660VAC/2000WVDC @ \$3 Four for 8.95
2mfd/3000WVDC \$4; 4mfd/3000WVDC 5.00
2mfd/5000WVDC \$10; 4mfd/5000WVDC 15.00
1mfd/10000WVDC \$20; 1mfd/25000WVDC 75.00
RCA 808; 446/2C40/2for\$5; 304TL 2 for 7.81
450TL/29; 807/95; 813/36.95; 815 2.19
845/33.75; 829B/3E29/32.90; 954/50c @ 5 for 2.00
5BPI, 5CPI, 5BPA/33.55 @; 3BPI & SOCKET 2.99
955, 56, 57, 58A, 59 & Socket/90c @; 2C26... .75
1625/65c; 2V3G/75c; 872A & SOCKET 2 for 5.40
SEND ORDERS FOR ALL TUBE REQUIREMENTS.
Tubes guaranteed exception breakage & open Fil.
WRITE FOR TUBE, PRECISION RESISTOR &
CONDENSER LIST 1.00
FREQ. METER MANUAL, SCR211 S.C.

UTC 8Hy/150ma NEW cracked Bake T'Bd... \$89
866A Combination transformer, 2 sockets&tubes 5.95
TRANSFORMER ONLY for TWO 866A Tubes 3.95
872A Combination Transformer, 2 sockets&tubes 12.00
872A Transformer 115V/60cy 6.95
CRYSTAL DIODE TEST SET 288U NEW 15.95
CRYSTAL DIODE IN34 @ \$1.39 TWO for 2.40
CRYSTAL DIODE IN21 @ 45c Three for 1.00
CRYSTAL DIODE IN26 @ \$1 Two for 1.50
CRYSTAL STD 200KC/0.1% acy Vacuum 5.95
CRYSTAL STD 7010KC/0.1% acy Two for 1.00
Vacuum Xtals GE 93.12 or 81.95KC ea. 2.95
HANDIE-TALKIE BC611 Chassis, Coils, X... 7.95
TRANSF 115 or 230V/50-60cy/1400 W Csd... 19.95
Auto transf 115/160/170/180V; 60cy Cased... 2.95
IF STRIP 30mes/85DBgain 8/8AK5 &
1/6ALS 2x11x2 1/2"H/12mes bnd width, outpt
Jack & COAXIAL Inpt plug Ideal IF
STRIP TELEVISION 9.49
TRANSF Modulation PP parallel 6L6's or
807's to PP RF 807's/2000ohm load 2.95
Transf 115V/60cy 7.5V/12amp H.V. each
Choke Swinging 15-29Hys/150ma each 2.95

\$2 Min. order FOB N.Y.C. Add Postage all orders
and 25% deposit w/rdth 2-7230. Send for catalog
99. Specialists in International Export, School, Col-
lege & Industrial trade. Money Back "TAB"
Guarantee.

KIT SPAGHETTI SLEEVING ASSTD 75 ft \$1.00
KIT HARDWARE GOOD ASSMNT 1 lb... .99
KIT GROMMETS RUBBER 100 ASSTD... .99
KIT MOTOR BRUSHES 100 ASSTD 1.00
KIT FUSES ASSTD BUSS & L.F. 300 for... 1.95
KIT KNOBS ASSTD WITH BUSHINGS 25 for 1.25
KIT ROTARY SWITCHES, 6 for 1.75
KIT POWER RHEOSTATS 25 & 50 W. 6 for 4.95
KIT W RESISTORS 20 for 1.00
KIT RESISTORS 1/2 4W/50to2megs 100 for... 2.50
KIT CONTROLS 50-2megs POTS AB/1 10 for 2.50
KIT SILVER & MICA CONDENSERS 50 for 2.00
KIT LUGS GOOD ASSMT 100 for 1.00
KIT ELASTIC STOP NUTS ASSTD 75 for... 1.00
KIT SOCKETS OCTAL, LOCTAL 4to 50 for... 2.95
KIT G&P Tube Grips ASSTD 50 for 1.00
KIT RADIO SOLOER 2 lbs98
AUTOSYNS TYPE 5/115V/60c NEW 2 for... 18.00
AUTOSYN TYPE 5/SynchroDifferential 6.95
AUTOSYN BENDIX TYPE 2/115V/60cy 2 for 18.00
AUTOSYN TYPE 5/50V for 115V/60c 2 for... 8.95
AUTOSYN 50V Synchro Differential 3.95
FOR AUTOSYNS-SELSYNS-MAGNESYNS C "TAB"

"TAB" • Dept. 9RC, Six Church Street, New York 6, N. Y., U.S.A. • "TAB"
THAT'S A BUY • CORNER CHURCH & LIBERTY STS., ROOM 200 • THAT'S A BUY

OPPORTUNITY FOR RADIO MEN!

Think of it. The average American home has at least 11 electric motors in it. Large homes have from 15 to 25—in washers, record players, oil burners, clocks, fans, mixers, refrigerators, etc. No wonder, then, that motor repair is such a good, well-paid business! It's a real "natural" for radio men to learn—and our big new book, **ELECTRIC MOTOR REPAIR** (see below) teaches you fast—teaches you right! Send coupon today!



**I'll Make it
EASY for you
to LEARN**

PROFITABLE ELECTRIC MOTOR REPAIR

**.. at only \$5 for the
complete, 553-page
Course!**

ELECTRIC MOTOR REPAIR, a big book by the publishers of Ghirardi Radio-Electronic books is a gold mine for radio men who want to expand along logical, profitable lines in an uncrowded field. Based on this big book alone, you can train for prompt, profitable service on practically ANY TYPE OF MOTOR IN COMMON USE—from fractional horsepower motors in home appliances, to big industrial motors. It tells exactly how to do everything from simple adjustments and repairs to complete rewinding. Covers AC and DC motors, synchronous motors and generators and BOTH mechanical and electrical control systems.

IT PAYS TO SPECIALIZE IN "SOMETHING DIFFERENT"

Every step of the work is explained simply as A-B-C, both in text and by more than 900 specially prepared diagrams and illustrations. No guesswork! Each phase of motor repair is clearly shown so there can be no mistaking. Quick reference guides show step-by-step how to handle specific jobs. When a motor comes in for repairs, just turn to **ELECTRIC MOTOR REPAIR** and see what to do. It's an ideal book, either for beginners or for bench use in busy shops.

Unique Duo-Spiral Binding divides book into two sections with text on one side, pictures on the other. Lies flat on the bench.

MONEY-BACK GUARANTEE

Send coupon now. PRACTICE from **ELECTRIC MOTOR REPAIR** for 5 full days—AT OUR RISK. Actually fix motors for yourself and friends. Then, if not more than satisfied return book to us and EVERY CENT OF YOUR MONEY WILL BE CHEERFULLY REFUNDED. No questions asked!

**"BORROW" IT FOR
5 FULL DAYS!**

NO RISK COUPON mail today

Dept. RC-97, Murray Hill Books, Inc.,
232 Madison Ave., New York 16, N. Y.

Send me a copy of **ELECTRIC MOTOR REPAIR** for which I enclose \$5 (\$5.50 foreign); or I send C.O.D. and I will pay postman \$5 plus postal charges. If I then decide I don't want the book, I'll return it within 5 days of receipt and you guarantee to refund my \$5 and no questions asked!

Name
Address
City & Zone State

LIGHTWEIGHT PORTABLE PHOTOFLASH

(Continued from page 23)

ploying the relay tube control triggering method in conjunction with a Kalart Synchro-strob instantaneous synchronizer instead of the self-ionizing flash tube circuit described by Mr. Greenlee in the February issue.

A small standard miniature plug receptacle is mounted close to the manual trip switch in one side of the handle to make connection with a short length of flexible double-conductor cord from the gun to the synchronizer.

A heavy steel bracket bent on an angle was made to mount the gun to the camera. Knurled thumbscrews in the camera tripod mounting hole and a fitting on one side of the gun makes the camera and gun readily detachable.

The handle of the gun is made from a length of heavy bakelite tubing 13 inches long by 1 3/8 inches inside diameter.

All parts shown in the wiring diagram, Fig. 1 and illustration Fig. 2 were mounted with Du Pont Household Cement in a piece of bakelite tubing 1 3/8 inch outside diameter 1-16 thick cut in half lengthwise to fit inside the tube handle. Seven 1/2-watt insulated carbon resistors, spark coil (model airplane motor ignition coil), and tubular paper capacitors, miniature socket, and OA5 trigger tube are mounted in this piece of tubing. Wiring is made with light polystyrene-covered stranded copper wire, keeping high-voltage leads well separated from ground and other leads. A 7-foot length of single conductor and copper braid co-axial cable with 2,000-volt polystyrene insulation is brought out through a hole in a bakelite disc cover at the bottom of the handle, see Fig. 2.

The socket for the R4330 flash tube was made from an Amphenol octal base, high-voltage safety socket with the upper molded shell cut off and unused pin connectors removed. The tube handle is bored out at the end, on a lathe, to fit the socket loosely and drilled and tapped through at opposite sides for 2 small flat-head machine screws to hold the socket firmly in place. The connections to the synchronizer plug receptacle and manual trip switch are soldered to leads brought through mortises cut in the upper part of the bakelite handle. The entire assembly is inserted into the flash-tube end of the handle after being assembled and wired. Mount the receptacle with small screws. An Amphenol 93-series co-axial connector is connected at the end of the co-axial lead to be inserted into the companion con-

ductor on the panel of the power supply unit. A standard 7-inch adjustable flashbulb reflector is available at any photo supply house. A reflector mounting band can be made easily from sheet brass and mounted with 2 small machine screws.

Synchronizers

The miniature receptacle and short flexible cord with plug shunted across the manual trip switch provided a convenient means of connecting to different types of synchronizers of either the

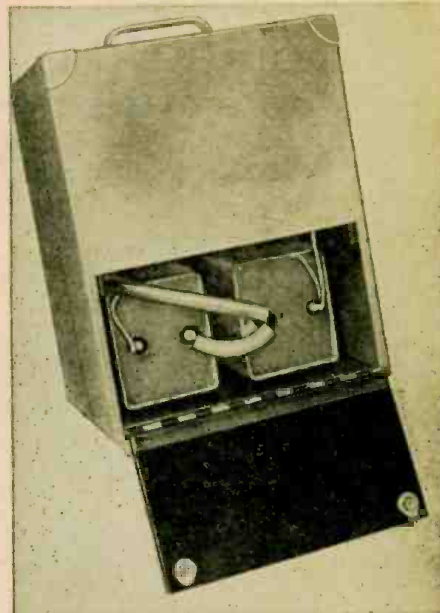

The two 25-uf, 2,000-volt storage capacitors.

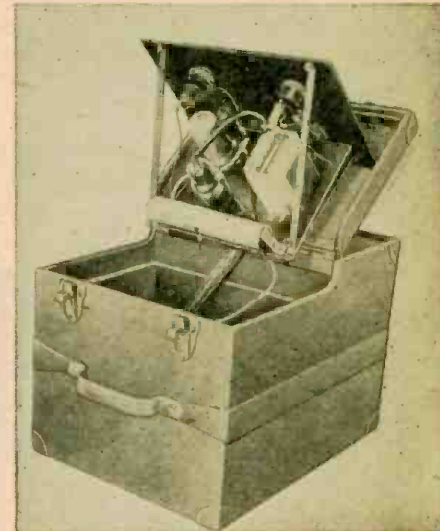

Placement of parts can be seen in this photo.

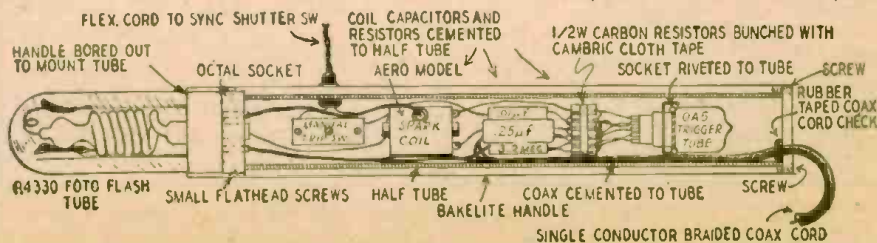

Fig. 2—Cross-section of the flash gun, showing placement of parts in the bakelite handle.

FIX ANY RADIO

Amazing New Invention



Find radio faults with a new simplified method. Repair all radios in minutes instead of hours. Revolutionary, different *Comparison* technique permits you to do expert work almost immediately. Most repairs can be made without test equipment. Simplified point-to-point, cross-reference, circuit suggestions locate faults quickly and easily.

PRICE ONLY
\$1.50
COMPLETE

CHARTS, BLUE-PRINTS, TESTS, PICTURES, HINTS, JOB-SHEETS

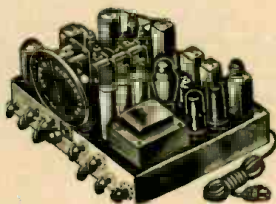

Learn time-saving trouble-shooting short-cuts; find any radio fault with ease. Follow the tests shown on 24 large circuit blue-prints. Over 1,000 practical repair hints. For all types of radios. Hundreds of simplified tests using a 5c resistor and any filter condenser. Introductory material for beginners and to serve as review for experienced radio men. Several chapters on test equipment. Complete plan in manual form, 64 job sheets, data on all tubes, large size: 8½x11 inches. Schematics, pictures, charts. Sold on no-risk trial. Use coupon to order.

NO TESTERS NEEDED REPAIR ANY RADIO IN MINUTES

This newly developed method tells you how to locate the source of trouble in any radio set without equipment. Make needed tests, measure voltage, trace the signal, by using only a 5c resistor, small condenser, and a crystal detector. Inject signals without any signal generator. Test parts by the new *Comparison* method. Test tubes without equipment. Repair any radio expertly following simplified picture plans. Improve your radio servicing ability. Data on all sets, portables, AC-DC, FM, recorders, intercoms, P.A. Examine and apply the plan for 10 days without obligation or risk. Send trial coupon today →

NO RISK TRIAL ORDER COUPON

SUPREME PUBLICATIONS

9 S. Kedzie Ave., Chicago 12, Illinois

Ship postpaid the new complete Simplified Radio Servicing by Comparison Method manual for 10 days' examination. I am enclosing \$1.50, full price. I must be entirely satisfied or you will refund my total remittance.

NAME:

ADDRESS:

built-in shutter variety or an auxiliary switching device. It is important to have perfect synchronization between the flash and the opening of the camera shutter, since the flash takes but 1/5000 of a second. Synchronizing with cameras which have fixed built-in synchronizers rarely requires adjustment.

Among the auxiliary instantaneous types of synchronizer switches available for use on cameras which are not provided with built-in synchronizers are the lens-board-mounting type and cable-release type. The latter can be used on almost any make of camera provided with a set-and-release type shutter. Those who obtain an auxiliary synchronous switching device will be given instructions for synchronizing it with their particular camera shutter, or most dealers will have it done for a small charge. Because of variations in shutter opening time when the fastest shutter speeds are used, it is recommended that 1/100-second (or slower) shutter speed be used when synchronizing with an auxiliary device.

In operating the unit the storage capacitor charges quickly, but it is best to allow about 15 seconds between flashes to assure time for the capacitors to charge fully. A weak flash or none at all will result in a poorly exposed negative.

The manufacturer's rated light output of the flash tube is approximately 12,000,000 lumens. Therefore, a comparison of shutter openings at a distance of 10 feet at 1/400 sec. follows:

Light Source	Film Speed (Weston-Tungsten Ratings)			
	16	32	64	125
R4330 flash tube	16.5	19	112	118
Press 25 flash bulb	16.5	19	113	118
No. 0 flash bulb	15	17.5	111.5	114
Press 40 flash bulb	16	19	114	120

To get the "f" number of the shutter opening for distances other than 10 feet, divide the number given below for your film speed light source by the distance in feet between the subject and light source.

Light Source	Shutter Speed	Film Speed (Weston-Tungsten Ratings)			
		16	32	64	125
R4330 flash tube	ANY	65	90	120	180
Press 25 flash bulb	1/400	65	90	130	180
No. 0 flash bulb	1/400	50	75	115	140
Press 40 flash bulb	1/400	60	90	140	200

PARTS LIST

- C1—2-uf, 2,000-volt condenser, Cornell-Dubilier Type TQ 20020
- C2—Two 25-uf 2,000-volt Cornell-Dubilier Type HKGT 101 photoflash storage condensers
- C3—.01-uf condenser, Cornell-Dubilier Type DT 451
- C4—.25-uf condenser, Cornell-Dubilier Type DT 4P25
- R1—100-ohm 100-watt wire wound resistor
- R2, R3, R4, R5, R6—Five 200,000-ohm ½-watt insulated resistors connected in series
- R7—4-megohm ½-watt insulated resistor
- R8—170,000-ohm insulated resistor
- R9—750,000-ohm insulated resistor
- R10—180,000-ohm insulated resistor
- R11—3.2-megohm insulated resistor
- R12—250,000-ohm insulated resistor
- R13—10-megohm insulated resistor
- R14—20-megohm insulated resistor
- S1—Panel-mounting toggle switch
- S2—Push-button switch, 220-volt insulated type
- S3—Manual trip switch, G-E miniature push-button SYN—Miniature plug receptacle for synchronizer
- T1—Power transformer, pri. 117 volt, sec. 2,200 volts, fil, tap 2.5 volts 1.75 amp. Unifed Transformer Corp. Type PF-1 or equivalent
- T2—Ignition transformer, sec. 15,000 volts or more, model airplane spark coil
- L1—117-volt pilot lamp
- L2—Neon pilot lamp
- Tubes—2X2, Sylvania types OAS and R4330

Radio production for the first 6 months of 1947 totalled 8,610,644 sound and television receivers. This is more radios than were produced in 1946.

Musical Distinction WITH ABSOLUTE FIDELITY AMPLIFICATION



A new amplifier development now enables you to clearly identify all the instruments in a full orchestra! If you are one of those discriminating persons for whom anything less than the best is a disappointment, you are one for whom the ACA-100DC Amplifier was designed. Send for literature.

AMPLIFIER CORP. of AMERICA

398 Broadway, New York 13, N. Y.

A.C. CURRENT ANYWHERE!

With Katolight Plants and Generators Furnish the same kind of Current as the highlines. Sizes 500 watts to 100 KW. Also Manufacturers of Rotary Converters, Frequency Changers, 32 and 110 Volt D.C. Motors in ¼, 1/3 and ½ H.P. A.C. Motors, single phase in 1½ and 2 H.P. only.

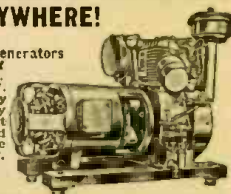

KATOLIGHT
120 Rock St., Mankato, Minn

RADIO-CRAFT will pay you \$6.00 for a GOOD photo of your radio service shop.

FOR HIGH FIDELITY AT LOW COST! -the UNIVERSITY TWEETER

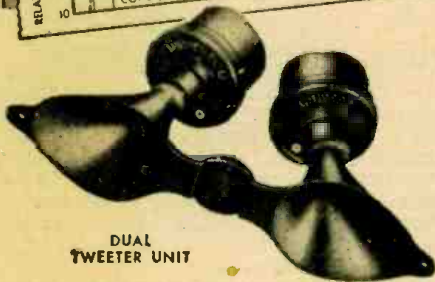
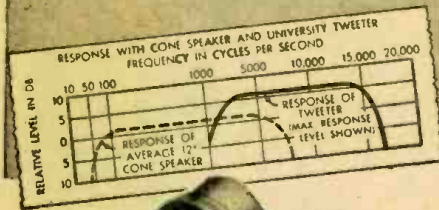

DUAL
TWEETER UNIT

The reproduction of music and voice with breath-taking realism, is now possible with the new UNIVERSITY Dual Tweeter. Used in conjunction with any standard 12" cone speaker in FM and AM radio equipment and wide range phonograph amplifiers, it adds the brilliant "highs" so frequently carried through all stages of amplification, only to be lost in the bottleneck of a single unit reproducer. Frequency response is 2,000 to 15,000 cycles. The die-cast dual horn design offers wider dispersion angle than the conventional single cellular horn—horizontal distribution is 100°, vertical distribution 50°. A high pass filter with auxiliary high frequency volume control, permits easy connection by merely attaching two wires to the existing speaker. Compact dimensions require a mounting space only 2 3/4" high x 9 1/2" wide. Power handling capacity of the dual unit is 16 watts. For complete information write today to UNIVERSITY LOUDSPEAKERS, INC. 225 Varick St., New York 14, N. Y.

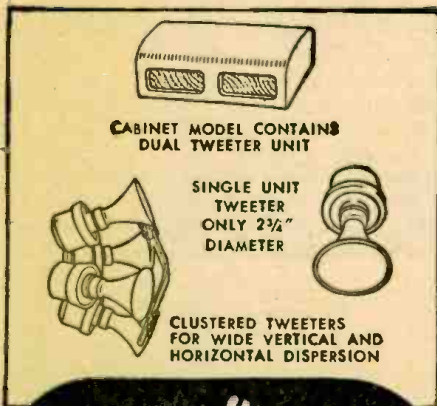

**University
Loudspeakers**

New Radio-Electronic Patents

By I. QUEEN

PHOTOGRAPHIC PHONOGRAPH

Sidney Appleby, Toronto, Canada
(assigned one-half to David Appleby)
Patent No. 2,416,135

This invention combines features of both disc and film recording. A record is made of celluloid coated on one side with a photographic emulsion. The record is held down flat on a turntable by glass. The celluloid has a circular set of holes which fit onto pins which extend from the turntable. A clamp also can be used to hold the glass plate against the celluloid and the turntable. In this way there can be no motion between glass plate, record, and turntable.

The glass plate is cut with a suitably spaced spiral groove so that it can guide a stylus and recording arm. The stylus is used only as a guide and does not record or reproduce. The recording arm also contains a light source which is adjusted to shine through the glass only between grooves. When it is suitably modulated as in film recording, a spiral sound track is recorded upon the record.

After developing, the celluloid record is ready for playback. It is placed upon a glass turntable and is held in place as described before. The reproducing arm has a stylus which rides the grooves in the glass plate and there is also a light source

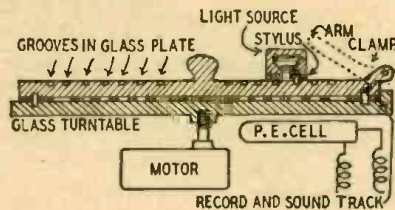

and optical system which focuses a beam between the grooves and through the sound track. This light beam passes through the glass turntable and falls upon a photocell beneath. The cell output is amplified and applied to a speaker which reproduces the original sound.

Advantages of this system include the absence of wear while the recording is used. A celluloid disc is easier to handle than a roll of film. The usual reproducing stylus is eliminated together with difficulties due to wear and limited frequency response.

R. F. OSCILLATOR

Clarence W. Hansell, Port Jefferson, N. Y.
(assigned to Radio Corp. of America)
Patent No. 2,420,744

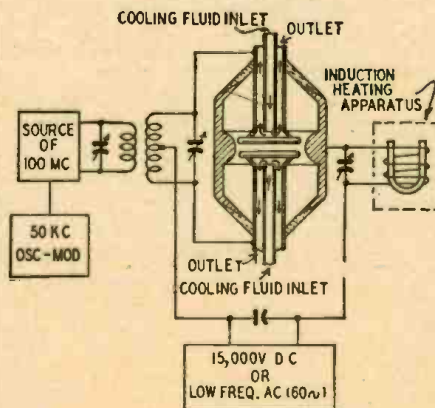

This patent relates to oscillators at such frequencies as are required for induction heating, for example. A frequency of about 50 kc is often used for this application.

The oscillator tube is of the highly efficient secondary-emission type which operates at very high frequencies. It contains 2 cathode discs coated

with electron-emitting surfaces. Space between the cathodes is very small compared with their diameters. A suitably shaped anode surrounds the discs and operates at very high potential. The cathodes are water-cooled to be the coolest part of the tube. Therefore, after evaporation, the electron-emitting particles condense back upon the cathodes and are not lost on some other part of the tube.

A 50-kc oscillator modulates a very-high-frequency oscillator. The tuned circuits can be of the transmission-line type tuned to about 100 mc. Due to cosmic rays or similar effects, one cathode may emit an electron which is received by the other cathode. Due to secondary emission, the latter emits several particles for each received. The effect is cumulative and builds up in a very short interval. If the tube transit time corresponds to 100 mc., the effect is maximum. At any instant, electrons are received by the more positive cathode from the other cathode.

Originally the effect is limited to areas near the centers of the discs, but as the space becomes filled with electrons they rapidly spread out. Those which appear near the cathode circumferences are attracted to the anode which drains them off as useful power in the external circuit. This circuit is tuned to the modulating frequency of 50 kc, which is applied to the induction heater.

TV COLOR CONTROL

Alfred N. Goldsmith
(Assigned to Radio Corp. of America)
Patent No. 2,416,918

Color television requires the transmission of 3 separate images, each of which appears in 1 of the 3 primary colors. These pictures are reproduced simultaneously or in sequence to make the final natural-color image. The present invention discloses a simple control to compensate for unusual conditions such as abnormal lighting, which may cause a change from the normal balance of the colors.

As shown in (a), light from the image passes through an optical system and a color disk and

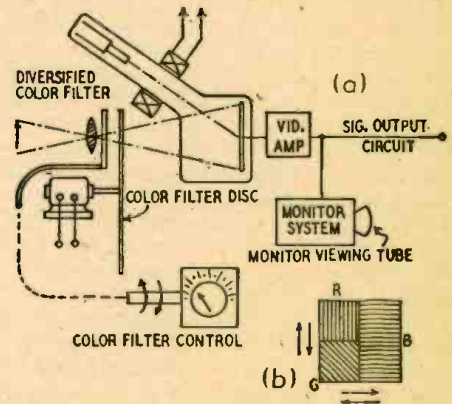

falls upon the target electrode of a television pickup tube. The disk is suitably divided into red, green, and blue portions so that as it rotates, it passes in turn a red, a green, and a blue image. The tube output is monitored and transmitted to further stages of the transmitter.

To control the color balance, a diversified color filter (b) is placed near the color disk. This filter is also composed of red, green, and blue sections, and under normal conditions its center corresponds to the axis of the optical system of the television pickup. If, for example, the blue is deficient during a given scene, the filter is displaced to the left so that this color covers more of the area of the light beam. In the same way all colors are controlled by simply displacing the filter as required. Either a mechanical cable or a system of Selsyn motors may be used to connect the filter with the control panel.

Previous electronic color controls have been far more complicated. Moreover they have had a tendency to produce noise and distortion.

POSTWAR FEATURES OF PHONOGRAPH PICKUPS
(Continued from page 37)

ance is about 7,500 ohms.) The carbon layers are connected across a d.c. potential source, and the current through them is modulated when the stylus (and beam) vibrates. With suitable design, the response can be extended to about 8,000 cycles.

Other new pickups

The magnetostriction pickup was fully described in the November, 1946, issue. It is now available as a high-fidelity reproducer, known as the TM pickup. It has an impedance of 200 ohms and an output of 0.004 volt. The stylus is osmium-tipped. The amplifier of Fig. 9 is recommended.

The FM pickup has been described in previous articles. A very tiny arma-

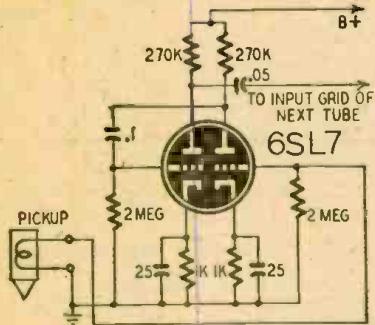

Fig. 9—Amplifier recommended for TM pickup.

ture is used to vary the capacitance between 2 metal plates. This change modulates the frequency of an r.f. oscillator. A discriminator and audio amplifier then follow. As in FM broadcasting, there is a marked absence of noise in this system. FM pickups are not available at the present time, but several manufacturers have announced their intention of making them.

A number of postwar magnetic pickups have a range much wider than the prewar types, and such pickups with a fairly flat characteristic from 50 to 12,000 cycles or more are available. These can be used to modernize existing phonographs, usually without any pre-amplification. Since they are greatly refined standard pickups, they present few or no new service problems.

EATON'S EXTRAS!!

Popular replacement items at savings up to one-half! Standard brands. Fresh stocks. Prompt service. All orders below shipped prepaid in USA!
* 20-20 mfd. 150 v. Tubular electrolytic condensers. Kit of eight only \$5.00 postpaid.
* 8 mfd. 475 v. Tubular electrolytic condensers. Kit of twelve only \$5.00 postpaid.
* Kit of 25 tubular paper condensers in assorted capacities. Per kit only \$2.00 postpaid.
* Kit of 10 tubular paper condensers, five each .01-600v and .1-600v. Per kit only \$1.00 postpaid (Solar only).
* Kit of 5 tubular paper condensers, .5mfd-4000v. Per kit only \$1.00 postpaid (Sprague only).
* Oscillator coils for 12A7's etc. 450kc. I.F. Per kit of three only \$1.00 postpaid.
EATON'S Box 471-C Logan, Utah

NOW *Sound* FOR YOUR SILENT PROJECTOR Economically

\$5995

Convert your 16mm silent projector to sound (regardless of make) with Apex sound head & radiofilm adapter. Guaranteed excellent performance. Write today for free information.

APEX VIDEO • 12209 U Branford St. • Roscoe, Calif.

TRANSVISION SCOOP!

NEW! SENSATIONAL! 12" TELEVISION KIT by TRANSVISION It's TOPS IN TELEVISION VALUE!

Again! TRANSVISION leads the field with this magnificent 12" Television Kit!

Engineered for Easy Rapid Assembly!

**SEE IT!
HEAR IT!**

The great performance of this superb set will shatter all your previous conceptions of television quality and value. **It's the TOPS IN TELEVISION!**

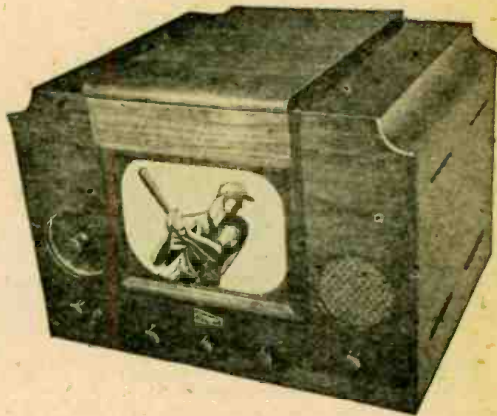

This new 12" Kit is available in two models:

STANDARD MODEL:

- Has 12" Picture Tube (magnetic type).
- Picture size 75 square inches, 7½" x 10".
- Receives all television channels now on the air with provision for Transvision factory to add new channels at no extra cost (except shipping charges).
- 4mc band width for full picture definition.
- 9000 volts second anode potential for brightness and contrast.
- 3 stages picture I.F.
- 2 stages pre-tuned and aligned I.F. coils.
- Ratio detector for sound provides High Fidelity F.M. Sound Reproduction.
- 22 tubes and 12" picture tube.
- Maximum picture sensitivity (approx. 50 microvolts).
- Stabilized synchronizing circuits to minimize interference on picture.
- Overall chassis size 24" wide x 18" deep x 4" high.
- Finest quality pretested parts throughout.
- Complete with SPECIALLY DESIGNED Folded Di-pole Antenna and 60 feet of lead-in cable.

DE LUXE MODEL with BUILT-IN F.M. RADIO:

Complete with all tubes. Folded Di-pole Antenna, and 60 feet of lead in cable. Has the same features as Standard Model described the above, plus the following

ADDITIONAL FEATURES:

- 50-216mc continuous tuning including F.M. band and 13 television channels.
- Switch provided to cut off unused tubes when used as F.M. receivers.

BEAUTIFUL FURNITURE FINISH CABINET Available at extra cost.

See your local distributor, or for further information write to:

TRANSVISION INC., Dept. RC, 385 North Ave., New Rochelle, N. Y.

All the Science of BASIC RADIO- ELECTRONICS in one 3½ lb. book



**ONLY
\$5**

Complete

**WRITTEN FOR
BEGINNERS**

36 COURSES IN ONE

If this big 972-page Book were broken into monthly lessons and sold as a "course" you'd regard it as a bargain at \$30 or more!



A. A. Ghirardi's famous 972-page, 3½ lb. RADIO PHYSICS COURSE book with its 500 illustrations and 856 Self-Test Review Questions can teach you basic Radio-Electronics quicker, easier and at far less cost than you may have

START NOW!

thought possible! It has given more people their start in Radio than any other! It is used more for home study and was more widely used in U. S. Army Signal Corps and Navy war-time training programs than any other book of its type!

LEARN IN A FEW WEEKS!

RADIO PHYSICS COURSE is written for beginners who want to learn at home in spare time. Many who never even studied a circuit diagram before have completed it in a few weeks. Every basic subject is fully covered. Nothing is omitted. You'll be pleased how quickly it has you understanding subjects that other books and courses make seem too complicated. Send coupon today! Our 5-DAY MONEY-BACK GUARANTEE protects you absolutely.

"Better than a \$150 Course!"

"I had already taken a \$150 radio course," writes Gerard Champagne of Montreal, "but since reading RADIO PHYSICS COURSE, I put the other one away. Ghirardi's is the book I need because it teaches so clearly!"

NO RISK COUPON mail today

Dept. RC-97, Murray Hill Books, Inc.
232 Madison Avenue, New York 16, N. Y.

Enclosed find \$5 (\$5.50 foreign) for a copy of Ghirardi's 972-page RADIO PHYSICS COURSE book; or send C.O.D. for \$5 plus postage (no foreign C.O.D.'s). In either event, if not satisfied, it is understood I may return book in 5 days for complete refund of my money.

Name

Address

City & Dist. No. State

**YOU'LL NEVER GO WRONG
on a GHIRARDI BOOK!**

ENGLISH REPAIR METHODS

IN England, radio servicemen are called "radio service engineers." These engineers are trained in the laboratories of the radio set manufacturers. Without exception every radio set manufacturer in England maintains a school where radiomen are taught the fundamentals of set servicing.

In addition these set manufacturers hold a twice-yearly refresher school lasting several weeks for all radio service engineers. Thus engineers are enabled to keep up with the latest developments, especially as regards television.

Radio service engineers in Great Britain do not usually own their own shops. Instead, they are employed by radio dealers and work on a weekly wage basis. Every radio dealer if any size in the British Isles maintains a service workshop. It is the radio dealers' responsibility to equip this workshop with the latest in precision testing equipment. In addition, there are a number of radio service jobbers—organizations which specialize in making radio repairs for retailers who do not have service workshops of their own. These service units work for the trade only under an arrangement whereby the radio retailer sending a set to them for repairs pays them a fixed fee plus the cost of replacements.

At the present time there are nearly 10,000 first-class radio service engineers—men who have worked at least 3 years in the service game. In the British Isles, until you have worked for several years in the field, you are classed as a second-class radio engineer; and for the first 6 months you are considered an apprentice.

At present virtually every radio service engineer in England belongs to the Guild of Radio Service Engineers which is—to all intents and purposes—a radio repairman's union. The Guild has negotiated an agreement whereby a certain minimum wage is paid its members throughout Great Britain. At the present time the Guild is working out agreements calling for overtime after 8 hours of duty and also requiring that radio dealers equip their workshops with test equipment meeting certain minimum standards.

There is plenty of work. At present labor is scarce at the radio factories and a number of the newer radio models arrive at the dealers in faulty condition, due to lack of inspection and checking.

In the past it has been difficult to persuade British radio dealers in general that such units as oscilloscopes, Wheatstone bridges, and tube testers are really essential.

At the present time the British radio service engineer seems to be divided in his preference as to a single or double beam scope. A new piece of apparatus that has just appeared on the market is a pattern generator for testing television receivers. This unit may be used

(Continued on page 66)

S.S.S.

"Servicing by Signal Substitution"

Learn about this modern dynamic approach to radio servicing with ONLY BASIC TEST EQUIPMENT.

... Fully described in a 120 page book available from your Precision Distributor or factory at 35¢.

... Schools are invited to inquire regarding quantity orders from our Educational Division.

PRECISION

APPARATUS COMPANY INC.
ELMHURST 4, N. Y.

Manufacturers of Fine Test Equipment
RADIO • TELEVISION • ELECTRICAL • LABORATORY

OPPORTUNITY AD-LETS

Advertisements in this section cost 20 cents a word for each insertion. Name, address and initials must be included at the above rate. Cash should accompany all classified advertisements unless placed by an accredited advertising agency. No advertisement for less than ten words accepted. Ten percent discount six issues, twenty percent for twelve issues. Objectionable or misleading advertisements not accepted. Advertisements for October, 1947, issue must reach us not later than August 27, 1947. Radio-Craft • 25 W. B'way • New York 7, N. Y.

CORRESPONDENCE COURSES AND SELF-INSTRUCTION books slightly used. Sold, Rented, Exchanged. All subjects. Satisfaction guaranteed. Cash paid for used courses. Complete information and 100-page illustrated bargain catalog. Free! Write—Neison Co., Dept. 39, Chicago 5, Ill.

MAGAZINES (BACK DATED)—FOREIGN, DOMESTIC, etc. Books, booklets, subscriptions, pin-ups, etc. Catalog 10¢ (refund). Cicero's, 863 First Ave., New York 17, N. Y.

FREE WHOLESALE BULLETIN, TUBES, PARTS. Bargain prices. Henshaw Radio Supply, 3313 Delavan City, Kansas City, Kansas.

AMATEUR RADIO LICENSES, COMPLETE CODE and theory for passing amateur radio examinations. Home study and resident courses. American Radio Institute, 101 West 63rd Street, New York City. See our ad on page 84.

WE REPAIR ALL TYPES OF ELECTRICAL INSTRUMENTS, tube checkers and analyzers. Hazelton Instrument Co. (Electric Meter Laboratory), 140 Liberty Street, New York, N. Y. Telephone—Barclay 7-4239.

"25 YEARS EXPERIENCE" RADIO REPAIRING AT your fingertips. I've perfected a simple system you can follow step by step. Requires no formulas or calculations. Cuts repair time to minimum. Total Price \$1.00 postpaid or C. O. D. Moneyback guarantee. Ross Radio Company, 14615-J Grandriver, Detroit 27, Michigan.

HOW MUCH DO YOU KNOW OF RADIO DEVELOPMENTS outside America? British experts are now producing many new ideas in radio and television fields. Details of these advances fully explained by leading technicians, are regularly included in PRACTICAL WIRELESS, Britain's foremost radio monthly. Other features include constructional details of all types of receiver, comprehensive blue-print service, free advice bureau, and valuable help and advice to expert and amateur alike. Indispensable to radio enthusiasts everywhere who want to keep ahead. Order NOW! Annual Subscription \$2.00 from Subscription Dept. PW 2, Tower House, Southampton Street, Strand, London, W.C. 2, England.

3" CATHODE RAY SCOPE, RADAR INDICATOR ID-93/APG-13A, 115v 400cps, complete with 11 tubes, compact, only \$25.00. Oil condenser, 2mfd 600 WVDC or 4mfd 400 WVDC, 10 for \$3.00. EIL Box 153, Shrewsbury, N. J.

ANY RADIO BOOK RENTED, 1, 3C A DAY, WRITE —L. Alexander, 780 E. 214 St., New York, N. Y.

SPECIAL ATTENTION: RADIO AND APPLIANCE immediately four copy of this copyrighted manual released for the first time to the radio and appliance industry. It fully covers all angles of post-war servicing, merchandising, and customer-getting psychological techniques. Increase your business efficiency and raise your income by knowing how to handle your customer and sell your services. Researched and written by professional service and broadcast engineers who have been through the mill. This manual now available to all interested parties at \$2.00, postpaid or C.O.D. Satisfaction Guaranteed. Address: Sparks and Kahane, Service and Broadcast Engineers, 206 West California St., Midland, Texas.

PRICES SLASHED—TERRIFIC BARGAINS—RADIO Supplies—Kit—Standard Tubes 60% discount—Free Bulletin—TECHNICAL LABORATORY—341 Wilson Ave. Brooklyn, N. Y.

RADIOMEN, SERVICEMEN, BEGINNERS—MAKE more money easily. \$250 weekly possible. We show you. Information free. Merit, 216-321L, 132nd Avenue, Springfield Gardens 13, New York, New York.

SOLDERING TAPE FOR SMALL ELECTRONIC work. Sample ten cents. M & G Hearing Aids Co., Box 517 Wellston Station, St. Louis 12, Mo.

WORLD-WIDE STATION LIST

(Continued from page 50)

Freq.	Station	Location and Schedule
9.530	SBU	STOCKHOLM, SWEDEN: 0130 to 0145; 1330 to 1700; 2000 to 2100
9.540	VLR	MELBOURNE, AUSTRALIA: 1620 to 1900; 2045 to 0220
9.540	LKJ	OSLO, NORWAY: 0200 to 0230; 0415 to 1700
9.540	CJCA	EDMONTON, CANADA: 0815 to 0900
9.560		SINGAPORE, MALAYA: 0315 to 0815; 0930 to 1100
9.550	XETT	MEXICO CITY, MEXICO: 0700 to 0100
9.550		PARIS, FRANCE: 0130 to 0145; 0530 to 0615; 0630 to 0800; 0915 to 0930; 1145 to 1615; 1630 to 1730; 1745 to 1830
9.540		ALGIERS, ALGERIA: 1230 to 1700
9.560		KOMSMOLSK, U.S.S.R.: 0100 to 0930; 1100 to 1400; 1545 to 1650; 1700 to 1830
9.580	GSC	LONDON, ENGLAND: 1100 to 1315; 1330 to 1415; 1430 to 1530; 1615 to 2300; 2345 to 0030
9.580	VLG	MELBOURNE, AUSTRALIA: 1100 to 1200
9.590	VUD4	DELHI, INDIA: 0030 to 0100; 0200 to 0400; 0430 to 0515; 0900 to 1230
9.590	PCJ	HUIZEN, NETHERLANDS: 1400 to 1900; 1745 to 1815; 2000 to 2200
9.600	XEYU	MEXICO CITY, MEXICO
9.600	GHY	LONDON, ENGLAND: 1800 to 2230; 2300 to 0030; 1230 to 1600
9.610	ZRL	CAPETOWN, SOUTH AFRICA: 0300 to 0700; 0900 to 1030
9.610	ZYC8	RIO DE JANEIRO, BRAZIL: 1500 to 2200
9.610	VLG6	SHEPPARTON, AUSTRALIA: 0830 to 1200
9.620	XGNC	KALGAN, CHINA: 0400 to 0815
9.610	TIPG	SAN JOSE, COSTA RICA: 0700 to 2330
9.620	CXA6	MONTEVIDEO, URUGUAY: 1530 to 2100
9.620	GWO	LONDON, ENGLAND: 0045 to 0130; 0200 to 0300; 0600 to 0630; 0700 to 0900; 1045 to 1400; 1700 to 2030
9.630	CKLO	MONTREAL, CANADA: 1600 to 1800
9.640	GVZ	LONDON, ENGLAND: 1500 to 1730; 1800 to 2230; 0100 to 0500
9.650	XG0Y	CHUNGKING, CHINA: 0630 to 1030
9.650	KRH0	HONOLULU, HAWAII: 0400 to 1100
9.650		MOSCOW, U.S.S.R.: 1100 to 1220; 2200 to 2235
9.670	VUD4	DELHI, INDIA: 0000 to 0130; 0900 to 0400; 0430 to 0515; 0730 to 0745; 0800 to 0830; 0845 to 1230
9.680	HVJ	VATICAN CITY: 1200 to 1330
9.680	XEQQ	MEXICO CITY, MEXICO: 0700 to 0045
9.680	VLB2	SHEPPARTON, AUSTRALIA: 0900 to 1200
9.680	EQC	TEHRAN, IRAN: 1200 to 1430
9.680	LRAI	BUENOS AIRES, ARGENTINA: 1600 to 1630
9.700		FORT DE FRANCE, MARTINIQUE: 0900 to 1245; 1800 to 1610; 1730 to 2030
9.710		MOSCOW, U.S.S.R.: 2300 to 0730
9.720	PRL7	RIO DE JANEIRO, BRAZIL: 0430 to 0900; 1415 to 1445; 1500 to 2100
9.730	XG0A	CHUNGKING, CHINA: 0900 to 1030
9.730	CSW7	LISBON, PORTUGAL: 1900 to 2000
9.740	OTC	LEOPOLDVILLE, BELGIAN CONGO: 1300 to 2015
9.820	GRH	VIENNA, AUSTRIA: 2345 to 2030
9.820		LONDON, ENGLAND: 1215 to 1600; 1700 to 2300
9.830	COBL	HAVANA, CUBA: 0715 to 0045
9.860		MOSCOW, U.S.S.R.: 2200 to 0200; 0830 to 0930; 1000 to 1200
9.900	ZTJ	JOHANNESBURG, SOUTH AFRICA: 0515 to 0715
9.930	SVM	ATHENS, GREECE: 1300 to 1800
9.960	HCJB	QUITO, ECUADOR: 0545 to 0845; 1200 to 2230
10.000	WWV	WASHINGTON, D.C.: U.S. Bureau of Standards; frequency, time, and musical pitch; broadcasts continuously day and night
10.000	XG0L	FOOCHOW, CHINA: 0400 to 1000
10.220	PSH	RIO DE JANEIRO, BRAZIL: 1700 to 1800
10.730	VQ7L0	NAIROBI, KENYA: 0500 to 0600; 0830 to 0915; 0945 to 1100
10.780	SDB2	STOCKHOLM, SWEDEN: 1100 to 1720
11.040	CSW6	LISBON, PORTUGAL: 0900 to 1130; 1230 to 1500; 1600 to 1800
11.090		PONTA DEL GADA, AZORES: 1500 to 1600
11.630		MOSCOW, U.S.S.R.: 1930 to 0300; 0600 to 0800; 0830 to 1300
11.650	XTPA	CANTON, CHINA: 0400 to 0915
11.680	GR6	LONDON, ENGLAND: 0600 to 0645; 0700 to 0900; 1000 to 1130; 1145 to 1200; 1230 to 1430
11.690	XORA	SHANGHAI, CHINA: 1830 to 2400; 0500 to 0930
11.700	HP5A	PANAMA CITY, PANAMA: 0700 to 2300
11.700	GVW	LONDON, ENGLAND: 2300 to 0030; 0600 to 0715; 0830 to 1015; 1130 to 1800; 1900 to 2330
11.700	SBP	STOCKHOLM, SWEDEN: 2000 to 2100
11.710	VLG3	MELBOURNE, AUSTRALIA: 0230 to 0345; 0100 to 0145
11.710	HEI5	BERNE, SWITZERLAND: Tuesdays and Fridays, 1000 to 1130; Saturdays, 1850 to 1625
11.720		KIEV, U.S.S.R.
11.720	PRL8	RIO DE JANEIRO, BRAZIL: heard at 0500

GOVERNMENT RADIO and ELECTRONIC SURPLUS BARGAINS

MODEL AN-PRS-1

NEW MINE DETECTORS

EACH \$9⁹⁵



12 Mfd Condensers

150 Volts — small tubular — Solar and Mallory.

EACH 17^c

TUBES

C6J (CE 306) GRID CONTROLLED RECTIFIER Gas Filled

Maximum Anode Amperes 6.4
Nominal D.C. Output Volts 330
Filament: Amps 18 Volts 2.5
Heating Time 40 Secs.
Peak Inverse Volts 1250
Peak Anode Current 77
Critical Grid Voltage -2
Cond. Mercury Temp. Limits 40° to 65° C.
Height 9 1/2", Width 2-1/16"
Base: 4 pin No. 412

PRICE EACH \$3⁹⁵

3B2Z (CE22Z) FULL WAVE RECTIFIER XENON FILLED

Maximum Anode Amperes 1
Nominal D.C. Output Volts 200
Filament: Amps 6 Volts 2.5
Heating Time 20 Secs.
Peak Inverse Volts Maximum 725
Average Ignition Voltage 12
Arc Drop Average Cond. Mercury Temp. Limits 40° to 65° C.
Height 6" Width 1 1/2"
Base: Medium 4 Pin

PRICE EACH \$1⁹⁵

4B24 (CE 224) FULL WAVE RECTIFIER XENON FILLED

Maximum Anode Amperes 2.5
Nominal D.C. Output Volts 200
Filament: Amps 12 Volts 2.5
Heating Time 30 Secs.
Peak Inverse Volts Maximum 725
Average Ignition Voltage 12
Arc Drop Average Cond. Mercury Temp. Limits 40° to 65° C.
Height 7 1/2" Width 2 3/16"
Base: Medium 4 Pin

PRICE EACH \$2⁹⁵

INVERTERS

27 V. Input, 115V. 400 Cycle Output at approximately 1500 Watts.

NEW, EACH \$7⁹⁵

GRAB BOX

Approximately 10 lbs. of miscellaneous radio parts. All usable — All new.

BOX EACH \$1⁰⁰



HIGH VOLTAGE TRANSFORMERS

90 V. Primary, 6400 V. Secondary, approx. 100 Mills. NEW, EACH \$1⁹⁵



CO-AX CONNECTORS

M359 — Right Angle Package of 10

79^c

BC-347 C AMPLIFIERS

NEW, EACH

75^c

OUTPUT TRANSFORMERS

Type No. 900835
CRV-30528
PRI-5000 Ohms
Sec. #1 500 Ohms Modulator
Sec. #2 600 Ohms Sidetone

RESISTANCE

PRI-120 Ohms
Sec. #1-20 Ohms
Sec. #2-5 Ohms

NEW, EACH

49^c

All Orders F.O.B. DETROIT, Shipped RAILWAY EXPRESS

RADIO CENTER

2530 EAST DAVISON AVE.
DETROIT 12, MICHIGAN

No order under \$5.00 — Please send check or money order. Orders shipped C.O.D. subject to 25% advance deposit.

RADIOMEN! ELECTRICIANS!

240 Page BOOK on "HOW TO START A SHOP OF YOUR OWN"



FREE

Here's an unusual "get acquainted" offer! This new 1947 book, "Starting & Operating a Profitable Electrical or Radio Business" is yours, absolutely FREE! It tells how to start and run a paying service shop right, on small capital, full or part time. Packed with practical information to help you get ahead in a shop of your own or working for some one else.

10 to 1 Satisfaction GUARANTEE

"I personally guarantee that at the end of 1 year from date of receipt, my 'Applied Practical Radio' set will have earned for you at least 10 times its cost, or you may return it and I'll return every cent you paid."

B. W. Cooke, Pres.



HOW TO GET YOUR FREE BOOK

You get this book Free just for looking over — without cost or obligation—the sensational new 3-volume Coyne set "APPLIED PRACTICAL RADIO". It's just off the press. Here's everything you want to know about radio, from basic principles to up-to-the-minute Television and

FM! PA, short-wave, aviation-auto radio, multi-bands, tele-transmission, etc., all clearly explained. Shows how to construct, install, service all types of apparatus. Step-by-step photos break equipment down before your eyes! Newest testing methods. Hundreds of subjects, almost 1000 pages, 600 illustrations, diagrams. Written for home training and field reference—so complete, so up-to-date and practical that every man interested in radio should see it.

SEND NO MONEY You can see how much this set can mean to your future, without cost or obligation. I'll send "APPLIED PRACTICAL RADIO" postpaid, for you to look over for 7 days FREE—and with it, the "Business Starting" book as an outright Gift! This book is yours to keep free whether or not you decide to keep the 3-VOLUME SET!

Coupon is Not an Order
Just a Request to See the Set Free

YOU ARE NOT BUYING THE 3-VOLUME SET WHEN YOU SEND THIS COUPON. You are merely asking to see the books free for 7 days. This coupon becomes an order only if you decide to keep the set after 7 days' Free Examination. Free Book Offer is limited — so mail coupon today.

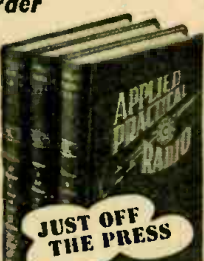

JUST OFF THE PRESS

FREE BOOK COUPON

B. W. Cooke, Pres., COYNE ELECTRICAL SCHOOL
Dept. 67-TI, 500 S. Paulina St., Chicago 12, Illinois

Send me the NEW 3-Volume Coyne Set "APPLIED PRACTICAL RADIO". Also send me the book "Starting & Operating a Profitable Radio or Electrical Business" which I am to keep FREE whether or not I keep the 3-book Set. I'll either return the 3-book Set in 7 days and owe nothing, or pay \$3 within 7 days and \$3 a month until \$10.75 is paid—or I'll send the cash price of \$9.75. You also include FREE one full year of Consultation Service.

NAME AGE.....

ADDRESS

TOWN ZONE..... STATE.....

Check here if you want to pay postman cash price of \$9.75 (you save \$1.00) on delivery. Same Money-Back Guarantee after 7 days' trial.

MOBILE XMITTER (Continued from page 26)

close to the antenna to indicate maximum output. The transmitting frequency is set by checking it with a calibrated receiver which is checked with a good frequency standard at regular intervals. To transmit, the receiver is set at the desired frequency and the grid condenser adjusted for maximum signal output. Then the plate condenser is adjusted, and finally the antenna coupling coil. Since each control affects the others slightly, the complete operation may have to be repeated. After the final tune-up, it is a good idea to split a rubber grommet and place it over the shafts coming from the tuning condensers. The dials are pushed down hard against this grommet while the set-screws are tightened. This prevents tuning changes because of vibration.

Several types of antenna systems were tried out. The one chosen is a vertical J. This is the simplest to mount and feed and it works well. The transmission line is No. 8 wire, spaced 1 1/2 inches. Every antenna used was directional to a certain extent with respect to the car.

This set has a real "sock" when used as a mobile transmitter. With the addition of an a.c. power supply and higher voltage, it can be moved into the shack,

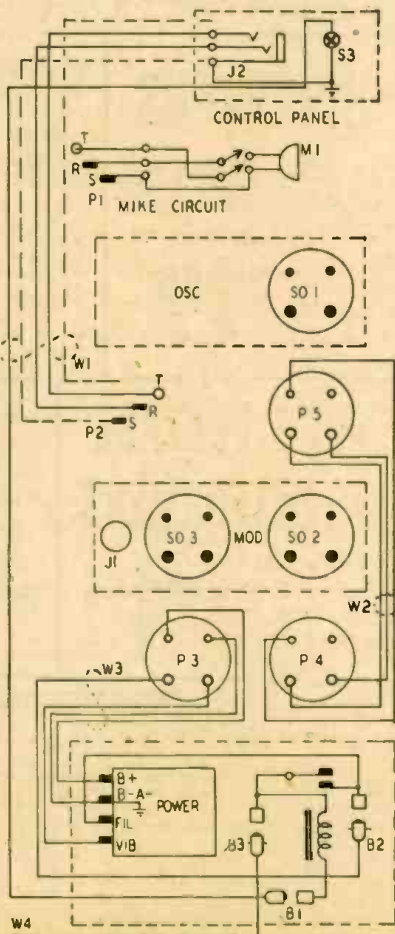

Fig. 3—Sections of the rig are connected with plugs and multi-conductor cables.

HERSHEL BEATS BARGAINS WITH LOWEST PRICES ON QUALITY MERCHANDISE!

Radio Tubes

813	\$ 5.45
8K60	1.25
VT127	2.95
VR15069
829	2.45
872	1.95
95565
900465
6J4	1.50
6J685
3AP7	2.45
3BP1	2.45
5BP1	3.95
5CP1	3.45
5FP7	3.45
7BP7	4.45
9LP7	5.45
304TH	6.95
1T1-3B4-3Q4-6SN7-6SL7-6SA7	
5U4G-5W4-35W4, ea.59
5U5B79

Condenser

Cat. No.	CAP. MFD.	Working Volts	Your Cost
CI10	5000 Oil	\$ 3.95
CI12	1000 Oil	.44
CI14	800 Oil	.95
CI15	600 Oil	.49
Westinghouse	1 MFD	6000 volts WVDC	7.95
Westinghouse	1 MFD	10,000 volts WVDC	12.95
General Electric	25 MFD	photo flash pranol-capacitor 2000 VDC-INT	14.95
IRC type HE	resistor	200 wt. tapped at 3000 7500, 23,750 ohms, Brand new	.49
144 MC	Radior	One, uses 15E or with variable coupling. Complete less tube	3.95
Thordarson	300MA	Power Transformer: 500/ct/500 tapped at 450/450. Extra bias winding 200/ct/100 at 50ma. 18 lbs.	4.95
BC 191E	less tubes	and tuning units	14.95
5V	Filament	Transformer 60 amps. 25 lbs.	5.95
Ear Phones	2000 ohms	used—in good condition	.95
Ass't resistors	1/2 watt	fully insulated in popular ohmage. Cat. No R-5 per 100	1.49
1MFD	7000 WVDC	Sprague	1.95
Plate transformer	Shelled Case	110-V 60 cy. Pri. 800 VAC-200 MA. Sec. not tapped.	3.95
Wafer Sockets	4-5-6-7 and 8 prong	Cat. No. WF-4 Per 100	2.95
12" Utah P.M.	Speaker	Alnico No. 5 with 6F6 output transformer. Cat. No. ST-100	6.95
Ass't knobs	push on wood and plastic	Cat. No. KP-100—per 100	1.95
Johnson sockets	No. 210-25V	Cat. No. JS-210	.49
Sockets for	acorn tubes	Cat. No. AT-10	.19
Jacks	PL 55 PL 68		.15
Powdered	3/8 slug		.10
1 Mck.	Shallcross	Acra-Ohm wire wound resistors ± 1V	.89
5 gang	app. 50 MMFD	per sec.	1.95
BC854	Transmitter and Rec.	with tubes and Xtal	14.95
SCR22	Trans. with tube and Xtal	like new	29.95
Modulation	Transformer	1KW	14.95
Famous Boat	Anchor Transmitter and Receiver		14.95
Scope Supply	Transformer	4000V	3.95
30MC	IF Transformer		.29
Corona Balls	dozen		1.00
Filament Transformer	110V, 60 cy. Pri. Sec.		1.49
5V 3A	shelled case		
Filament Transformer	110V, 60 cy. sec. 2.5V at 5.25 amps. shelled case		2.45
Filament Transformer	110V, 60 cy. sec. 1.5V at 10 amps. sec 2.5V at 10 amps. connected in series will give 10V at 10 amps. shelled case		3.95
General Electric	meter, type D041, 0-10-MA, or 0-500MA 3/4" round case ea.		3.95
BC223 AX	Transmitter	Brand new	29.95
Variac	1 amp		3.95
Variac	5 amp		7.95
Assorted HF	chokes, dozen		.50

BRAND NEW SCR269F Automatic Direction Finder Radio Compass complete with component parts **75.00**

Minimum order \$2.00 f.o.b., Detroit. Michigan sales add 3% sales tax, 20% required on all c.o.d. orders

HERSHEL RADIO CO.

5249 Grand River
DETROIT 8, MICHIGAN

WATCH OCT. ISSUE for Announcement of Hershel's GIGANTIC SALE

where the full capabilities of the HK24's can be realized.



Rear of rig. Note swinging antenna link.

LIST OF PARTS

C1—100 μ f (See text)
 C2—.001 μ f, 600 v
 C3—.001 μ f, 600 v
 C4—.004 μ f, 600 v (mica)
 C5—100 μ f per section (National TMS 100 D)
 C6—.001 μ f, 600 v
 M—0.35 ma
 V1, V2—24-G or HK24
 L1—3 turns No. 8, $\frac{3}{4}$ in. diam, $\frac{1}{2}$ in. long
 L2—4 turns No. 8, $\frac{3}{4}$ in. diam, $\frac{1}{2}$ in. long
 L3—1 turn No. 8 $\frac{3}{4}$ in. diam
 Ch. 1—10 turns No. 16 e.c., $\frac{1}{2}$ in. diam, double-spaced
 Ch. 2—10 turns No. 16 e.c., $\frac{1}{2}$ in. diam, double-spaced
 CH 3—50 turns No. 26 d.c.c., close-wound (L1 and L2 are bare copper, silver-plated.)
 C7—100 μ f, 10 v
 C8—20 μ f, 25 v
 C9—0.1 μ f, 600 v
 R2—220 ohms, $\frac{1}{2}$ watt
 R3—1,500 ohms, $\frac{1}{2}$ watt
 R4—10,000 ohms, $\frac{1}{2}$ watt
 R5—500,000 ohms (gain control)
 T1—Mike trans., 200 ohms to single grid
 T2—Input trans. (class B)
 T3—Modulation trans. (1-1 ratio, 6,000 ohms)
 J1—3-circuit mike jack
 S-1—S.p.s.t. switch (test key)
 S-2—S.p.s.t. switch (safety switch)
 K1—Relay, s.p.s.t., 6 v, 20 amp
 S-3—S.p.s.t. toggle switch
 J1—3-circuit mike jack
 P1, P2—3-circuit mike plugs
 P3, P4, P5—4-prong male plugs
 So-1, So-2, So-3—4-prong tube socket
 K2—S.p.s.t. 6-v relay, 30 amp
 B1, B2, B3—Battery connectors
 W1—2-wire mike cable, shielded
 W2—3-wire cable, No. 14 wire
 W3—4-wire cable, No. 14 wire
 W4—Hot lead to car battery, No. 10 wire
 Pwr—Mallory VP-555, 300 v, 200 ma
 M1—Single-button carbon microphone with push-to-talk switch

CORRECTION

In the article, *Easy-to-Build Oscilloscope*, in the May, 1947, issue, the connections to the horizontal and vertical centering controls are incomplete. The controls consist of two 4-megohm potentiometers in parallel with one end of each connected between the 750,000- and 250,000-ohm resistors in the bleeder of the half-wave rectifier. The other ends should be connected to the junction of the 25,000- and 10,000-ohm resistors in the bleeder of the full-wave rectifier.

We thank Mr. Jesse Dilon, of Brooklyn, N. Y., for this correction.

AS GOOD AS IT LOOKS



MODEL S20X

WITH SLIDE-LOCK SWITCH AS ILLUSTRATED AT SLIGHT EXTRA COST

ALL THESE FEATURES AT LOW COST

- ★ Metalseal crystal
- ★ High level: 54db below 1 volt/dyne/sq. c.m.
- ★ Smooth response: \pm 5db from 50-7000 c.p.s.
- ★ Corrosive resistant aluminum diaphragm
- ★ Convenient, light weight
- ★ Modern styling
- ★ Turner quality

Microphones BY TURNER

It's the new Turner Model S20X Hand Microphone for home recording, public address and amateur work. Beautifully finished in rich baked brown enamel. Light in weight and convenient to use. Fits the hand perfectly, hangs on a hook when not in use.

Its performance is the kind you expect in a microphone costing three times as much. Response to voice and music pickups is smooth and flat over the most desired frequency range. Level is exceptionally high. The entire circuit is shock mounted to withstand rough treatment and is equipped with barometric compensator.

SEND NOW FOR BULLETIN



THE TURNER COMPANY

900 17th Street N.E. • Cedar Rapids, Iowa

TURN TO TURNER FOR SOUND PERFORMANCE

CRYSTALS LICENSED UNDER PATENTS OF THE BRUSH DEVELOPMENT CO

3 WAYS TO BE AHEAD in Buying Test Equipment



Model 599-A Tube and Set Tester

SPECIFICATIONS
 DC Volts — 5 ranges 0/6/15/150/600/1500 volts, 1000 ohms per volt.
 AC Volts — 3 ranges 0/15/150/600 volts.
 DC Current — 3 ranges 0/6/60/600 milliamperes.
 Output Volts — 0/15/150/600
 Ohmmeter — 4 ranges 0/200/20,000 ohms and 0/2/20 megohms.

Condenser Checker — Ohmmeter provides fast method of checking leakage of both paper and electrolytic condensers.

Battery Tester — Tests most commonly used dry portable batteries of 1.5/4.5/6.0/45/90 volts. English reading "Replace-Good" scale.

- 1 BUY ACCURACY
- 2 BUY DEPENDABILITY
- 3 BUY SUPREME-ACY

Ask your nearest SUPREME jobber for a demonstration of Model 599-A Tube and Set Tester (above), Model 561-AF & RF Oscillator, Model 546-A Oscilloscope, Model 592 Speed Tester. Ask to see the complete line of SUPREME equipment.

SUPREME

Tube Testing — Circuit incorporates proven and modernized emission circuit. Checks for short, leakage, and noise tests between elements.
 Power Supply — 100-133 volts—50/60 cycles. Special voltages and frequencies on request.

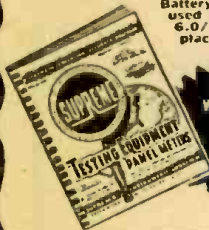

WRITE FOR
NEW
CATALOG

SUPREME INSTRUMENTS CORP., Greenwood, Miss., U.S.A.

Export Department: THE AMERICAN STEEL EXPORT CO., Inc.,
1347 Madison Ave., New York 17, N. Y., U.S.A.

SIGNAL TRACER-INJECTOR

(Continued from page 31)

the various stages. This is done to ascertain the approximate signal strength. When with the probe placed near a certain stage, the signal is greatly reduced or nonexistent as compared to the tests made under normal operation, that is the particular stage causing the trouble. Thus the number of components that need be checked can be reduced.

For receiver alignment

Use of the signal injector as an aid in aligning the receiver will save time and annoyance in adjustment of the low-frequency padding condenser. Align the receiver in the regular manner, then attach the output of the signal injector to the antenna to align the 600-kilocycle padding condenser. Set dial at 600 kilocycles and the output of attenuator to the lowest level the output meter will indicate; then adjust the padder for maximum indication. It is not necessary to rock the dial as is the case when the conventional signal generator is used.

All parts values are given in the accompanying circuit diagram. The total cost of the unit should be around \$10, including salvage from the junkbox. The probe cable should be about 2 feet in length and shielded as close to the tip as possible; that is, run the shielding inside the insulating material used for the probe to prevent the signal from being induced into the body and radiated to the various stages of the receiver. This is possible, and would result in erroneous deductions as to which stage of the receiver is at fault.

The photograph of the completed tester shows a toggle switch which is a d.p.d.t. type used as the changeover switch from signal injection to signal tracing. The 3 pin jacks are listed 1, 2, and 3 in the schematic. Jack 1 is on the right side, with No. 2 the ground, and No. 3 the jack on the left. It would be preferable to include another ground jack adjacent to jack 3 to make the ground connection to the shield of the probe, eliminating the necessity of making 2 connections to the single ground when the circuit is used as a signal tracer. The pointer knob is the a.c. switch and attenuator.

When it is desired to use the tester for signal tracing, throw the changeover switch to the proper position and make connections from jacks 1 and 2 to a suitable speaker, as mentioned previously. Connect probe to jack 3 and use as any signal tracer to determine whether the signal is passing that particular stage. Due to the capacitance of the lead to the probe, some detuning will occur when it is applied to r.f. or i.f. amplifiers. However, if suitable low-capacitance shielded cable is used this will not be objectional except on short-wave.

Because of the great amount of printed matter available on signal-tracing technique, nothing on this phase of the subject is included here. Back copies of RADIO-CRAFT cover the subject.

RED HOT SPECIALS

Limited quantity for immediate shipment—while they last

8,000 OHM DUAL HEADSET H-16/U



Priced at **\$1.89**

★ MOST SENSITIVE PHONES BUILT

★ HI-IMPEDANCE

★ NOISE PROOF

★ MAY BE USED AS A SOUND POWERED INTERCOM

ORIGINAL COST—\$25.00

Light, durable, and efficient phones featuring a permanent magnet with an 8000 ohm transformer built into each unit. Molded soft neoprene earcup shaped to snugly and comfortably envelop the entire ear. Steel headband with new type adjustable sliding brackets allow earcups to be extended or retracted. Cover plates constructed of lightweight magnesium. No removable parts to become loose or lost. Especially suited to hams and commercial operators, recording engineers, aircraft pilots and similar exacting applications. HI-impedance, extremely sensitive. May be used as sound powered interphones without use of a battery. Can even be used with simple xtal to make a complete radio receiver.

Carbon Throat Microphone

This microphone will work into any 200 ohm impedance input circuit. Has adjustable strap to fit any neck. In operation this microphone is strapped around the throat thereby facilitating full freedom of both hands and head movement. Ideal for ultra high frequency mobile work for hams. Supplied with strap, 10' cord and plug. Your Cost



49c

Combination Offer
\$2.25
Both Items

20% deposit on all orders unless rated.

NIAGARA RADIO SUPPLY

160 GREENWICH ST., NEW YORK 6, N. Y.
BOWLING GREEN 9-7993

All prices F.O.B. N.Y.C. WRITE FOR LATEST BULLETIN 9RC.

NEW INSIDE DOPE ON IDEAL AMPLIFICATION
SEND 3c STAMP FOR POSTAGE
AMPLIFIER CORP. of AMERICA
398 Broadway, New York 13, N. Y.

Overproduction is cited as the chief cause for 22 radio business failures during the past fiscal year. Nine of the failures were set manufacturers, 7 amplifier and record player manufacturers, and 6 radio parts makers.

Unbalanced inventories and price reductions were also failure factors.

FREE! SEND FOR IT

ALLIED'S 164-Page RADIO CATALOG

Save on Everything in Radio!



Here is everything in radio—in one BIG, easy-to-use book—at prices that save you money! New radios, phonos, complete PA equipment, test instruments, Ham equipment, thousands of parts, tubes, tools, books, diagrams, kits—everything for the experimenter, builder, serviceman, amateur. Send today for this COMPLETE Buying Guide. Get everything you need—save at ALLIED, Radio's expert, dependable supply source.

RADIO BUILDERS!



Low-Cost 5 Tube Kit
Complete with Cabinet, Loop Antenna & Tubes

The first ultra-modern 5 Tube AC-DC Superhet kit at so low a price!

Here's what you get—full broadcast coverage (550-1600 Kc.); built-in loop antenna; latest 5" PM dynamic speaker; handsome walnut plastic cabinet. Easy to build; no special tools required. Sockets are riveted in place; just assemble, wire and slip into cabinet. Outstanding power and tone quality. Highest grade components. Complete with all parts, tubes and full instructions. Nothing like it at the price! Shipping weight, 10 lbs. No. 83-275. Complete. **ONLY 1495**



More than 10,000 items—Complete lines of all leading makes. Largest stocks of hard-to-get parts. Lowest money-saving prices. Get everything you need in Radio from ALLIED!

Public Address—entirely new line—new styling, new design features. Packaged Ready-to-Use Sound Systems; everything in amplifiers, speakers, mikes, intercom and recording.

Amateur Gear—immediate delivery on latest communications receivers. Time payment plan; trade-ins accepted. Headquarters for all ham and experimenters' needs.

Handy Radio Books

- Radio Formulas and Data Dictionary of Radio Terms
 - Radio Circuit Handbook
 - Radio Builder's Handbook
 - Simplified Radio Servicing
 - Radio Data Handbook
- ALL SIX BOOKS No. 37-799 . . . \$1.00
- Parallel Resistance and Series Capacitance Calculator. No. 37-960 . . . 25c
 - R-F Resonance and Coil Winding Calculator. No. 37-965 . . . 25c

ALLIED RADIO

ALLIED RADIO CORP.
833 W. Jackson Blvd., Dept 2-J-7, Chicago 7, Ill.

- Send FREE 164-Page Catalog
 - Send Kit No. 83-275
 - Send 6 Books No. 37-799
 - Send Calculator No.
- } \$..... enclosed

Name

Address

City.....Zone.....State.....

BC-624 ON 2-METERS

(Continued from page 25)

not actually used are removed entirely from the chassis.

The S-meter is a 0-1 ma type movement. A new scale was drawn up with the caption CARRIER LEVEL inscribed. A standard 7 x 19-inch, relay-rack, aluminum panel was attached to the receiver with 2 pieces of sheet metal. Sufficient space was left between the panel and set to clear the various controls and the S-meter. After all holes were drilled, a coat of gray crinkle-finish was applied to the panel. The lettering was done with a Millen decalcomania kit.

Front panel controls are as follows: On-off switch for the 117 volts a.c., on-off switch for a.v.c., audio gain control, a.n.l. switch and transmit-receive switch.

The S-meter adjustment control extends out of the top of the receiver chassis and is easily accessible, being next to the 12AH7-GT tube. This is seldom used after initial adjustment.

By following the original schematic, as well as the modified schematic printed here and the various photographs it should be easy to make the conversion.

Aligning the receiver

The original harmonic generator tube, the 9002, becomes the local heterodyne oscillator in the new setup. By using the same coil and rearranging the parts slightly, it will oscillate normally 12 mc below the signal frequency. Signals may be heard, however, 12 mc above the received signal frequency. One may find after becoming familiar with the tuning characteristics that in certain instances it will be advisable to use the high side. It will be found also that the r.f. and mixer controls will tune easily as low as 88 mc if the coils are squeezed together just a bit, while the high range will still extend to 158 mc. When tuning the range from 88 to 100 mc, the oscillator will of necessity be operating on the high side of the signal, that is, 100 mc to 112 mc. Thus, the receiver will cover the new FM band as well as the range from 108 to 158 mc.

Should one be interested primarily in FM reception, it will be necessary to incorporate a limiter and discriminator stage for satisfactory reception. The i.f. transformers are wide enough (maximum 150 kc) for this work and should prove very satisfactory in FM service if the necessary changes are made.

A further improvement

As a final refinement for AM operation—after the operator has become familiar with the tuning controls and knows what to expect—the r.f. and mixer tubes may be removed and high-gain 6AK5's substituted in their place. Improved reception will result, but a couple of precautions must be observed. Since the 6AK5's use a maximum of 180 volts and the removed 9003's as

TG-10-F AUTOMATIC KEYS



OPERATION (a) Designed primarily to read standard code signals from inked tape by means of a photo electric system and to transmit these signals to a number of headsets or practice tables for code practice.

(b) Can be used as a separate tape puller and take-up unit for use in conjunction with certain types of recorders which do not perform these functions.

(c) Can be used in conjunction with a transmitter and/or code Receptor BC-1018 to send or relay messages at high speeds (see text).

OUTPUT: Audio signal of 800 cycles. Three output impedances of either 4, 8 or 15 ohms for coil load matching.

COMPONENTS: 110 volt Variable Speed Drive Motor—Take-up reel—Practice reel of inked tape—Technical manual—Photo Electric system—25 Watt Amplifier and oscillator circuits Complete with the following tubes: 2-6N7's; 2-6SJ7's; 2-6L6's; 1-5U3G; 1-9Z3.

Complete ready to use in steel cabinet 11" high x 24" wide x 18 1/2" deep, wt. 63 lbs. Designed to fit any standard 19" relay rack. Height is 8 3/4" and weighs 40 lbs. when cabinet is removed for rack mounting.

Fully equipped and assembled—Just connect to your headphones, etc., and plug into your 110 volt 60 cycle power line.

Surplus — New — Guaranteed
NET FOB, NY \$19.95

UNBELIEVABLE

A TRANSMITTING & RECEIVING SET NET FOB, NY \$8.95



SIGNAL CORPS S.C.R.—17R
2400 to 3700 K.C. Master Oscillator Tuning C.W. Voice-Tone; 5 Watts 25 miles on C.W. Takes in some police, marine, aircraft and amateur bands. Consists of 4 SEPARATE COMPONENTS: Transmitter, Receiver, Modulator and Battery Box. Receiver operates separately on standard radio A, B and C batteries. Transmitter operates from any external source of 8 volts at 3.25 amp and 500 volt at 400 M.A. Set uses the following tubes: 1 No. 10; 1 No. 8B5; 2 No. 8's; 4 No. 30.

To be put COMPLETELY into operation you require only the following:—
Batteries, Tubes, headphone, mike, key, antennae, and power source for transmitter.
In this set are 3 meters: 0-1 Amperes R.F.; 0-200 Milliamperes D.C. and a dual range 0-25 and 0-140 D.C. Voltmeter. THE COMPLETE SET CAN BE PURCHASED FOR ONLY THE PRICE AT WHICH WE NORMALLY SELL ONLY THESE THREE METERS \$8.95 F.O.B., N.Y. This set is worth many times this special price as it can be readily modified or used for the valuable parts it contains.
Condition: Guaranteed New—Never used—not rejects—in perfect operating condition. Made by Allen B. DuMont Laboratories, Inc. Shipping wt. 80 lbs. Dimensions 25 1/2" x 17 1/2" x 10 1/2".
What's the hitch? There is none! We SPECIALIZE IN ALL TYPES OF METERS but do carry various components such as this from time to time. We have only 300 of these units left in stock and we won't have them long at this amazingly low price so get your order in while the getting is good.

BC-1072-A RADAR TRANSMITTER

150 to 210 Megacycles: Operates on 115 volt 60 cycle. Can be adapted to 2 meter band x'mtr. Chief value is for parts.
BLOWER 115 volt 60 cycle 28 watts .38 1525
R.P.M. A.G. Redmond
VARIAC Gen. Radio type 200 B 115 volt input. 135 volt 1.5 amps Max. output
TUBES 2-5Y4G's; 1-807; 1-2x2; 1-6SN7; 1-6J5; 1-90D2; 2-90D6; 2-2Z5
METER Simpson, 3 1/2", round, 0-5 Kilovolt and 0-10 M.A., D.C.
3 complete power supplies 3500V.-700V.-300V. Numerous valuable parts.

GRAND NEW NET FOB, NY \$22.50 NET WT. 150 LBS.

Send for free Circular MARITIME SWITCHBOARD

336A Canal Street New York 13, N. Y. Worth 4-8217

much as 250 or 300, it will be necessary to drop the supply voltage feeding these stages. This is done simply by changing one resistor and adding another.

Substitute a 50,000-ohm, 1/2-watt, carbon resistor in place of original resistor No. 263-1 (4,700 ohms). This number is indicated on the original schematic. Next, insert a 10,000-ohm, 1-watt, carbon resistor in the B-plus line feeding the plate and screen of the r.f. amplifier stage. These changes will place the correct operating potentials on the 6AK5's. Since the new tubes are slightly different in characteristics from the 9003's, the r.f. trimmers will have to be readjusted to maximum signal. It may be necessary to loosen the 1-turn link coil between the mixer and harmonic amplifier stages. This is done by bending the loop away from the mixer grid tank circuit and decreasing the inductance reaching the tube.

In all of this preliminary lining up of the receiver, a signal generator covering the range 88 to 108 mc is very convenient and will save time. Most of the commercial signals above about 100 mc and up to 144 mc are intermittent and do not stay on the air long enough at one time to permit peaking and tracking the r.f. trimmers.

If the antenna to be used on the receiver terminates in a 50-ohm co-axial transmission line, no changes are necessary in the input coupling coil. Should another type be used, for example a 300- to 600-ohm line, the original 1-turn link should be removed and a 2- or 3-turn coil of the same diameter and form substituted. Ungrounding the lug on one side of this coupling coil permits the use of a balanced input circuit.

This receiver was tested alongside one of the commercial models costing over \$300. Of the two it was much more sensitive on the 144 mc amateur band as well as over the rest of its tuning range. Signals barely discernible on the commercial job were in the order of S6 to S8 on the amateur special BC-624-A.

Radio Thirty-Five Years Ago In Gernsback Publications

HUGO GERNSBACK Founder

Modern Electrics	1908
Electrical Experimenter	1913
Radio News	1919
Science & Invention	1920
Radio-Craft	1929
Short-Wave Craft	1930
Wireless Association of America	1908

Some of the larger libraries in the country still have copies of ELECTRICAL EXPERIMENTER on file for interested readers.

September, 1913, ELECTRICAL EXPERIMENTER:

Wireless Time-Signals from the Eiffel Tower, by *F. Hope Jones*
Condenser Telephones
Electricity from Hot Metals
Reception of Wireless Time-Signals, by *H. Winfield Secor*

Wireless from Auto
4,000 Miles by Wireless
Radio Storm Signals
Wavelength of Loose Copper
Commercial Wireless Sets

Lick any Radio Repair Job ...IN LESS TIME... WITH LESS WORK!



Alfred A. Ghirardi

GOODBYE TO TEDIOUS TESTING

Contains repair data on

Admiral	G-E
Airline	Majestic
Arvin	Philco
Belmont	RCA
Capohart	Silvertone
Cresley	St.-Warner
Emerson	Strom-Carl.

and 198 other makes!



only \$5

... and a lot MORE PROFITABLY

4 radio repair jobs out of every 5 can be handled as easy as falling off a log! Problems that might puzzle you and call for hours of tedious testing can be solved in an instant! Just look up the make and model of the set to be repaired in the Trouble Case History section of Ghirardi's famous RADIO TROUBLESHOOTER'S HANDBOOK. Then go to work! Clear, easily understood instructions tell you exactly what the trouble is likely to be—exactly how to fix it. No lost time or motion. Work twice as fast. Make twice as much money!

SERVICE DATA ON ALMOST EVERY RADIO USED TODAY!

The 4 lb. 744-page manual-size HANDBOOK contains carefully compiled service notes on over 4800 models of 202 manufacturers—practically every radio in use today. Statistics show it covers well over 90% of all jobs brought to servicemen! Everything fully indexed so you can find it quickly. Everything thoroughly explained.

Hundreds of additional pages contain i-f alignment, peaks; transformer trouble listings; tube data; and dozens of graphs, diagrams and service data to help you repair ANY RADIO EVER MADE better, easier and TWICE AS FAST! Only \$5 complete—and you don't risk a cent. Our 5-DAY MONEY-BACK GUARANTEE is your absolute protection. Use coupon.

MONEY-SAVING OFFER

Let the HANDBOOK save you time on common service jobs. Let MODERN RADIO SERVICING train you for truly professional work. Get BOTH big books at Combination Price of only \$9.50 for the two. Use coupon today!

only \$5



BE A Professional RADIO-ELECTRONIC SERVICE EXPERT

Don't be a low-paid service hack! Learn to service by modern, scientific analysis methods. Qualify for the big money work, not only in servicing but in all sorts of industrial electronics. Get the real KNOW HOW of truly professional servicing—in a few short weeks—at home without an instructor—for only \$5 complete!

Whether you're already in servicing or only planning to train for it, A. A. Ghirardi's 1300-page MODERN RADIO SERVICING will prove worth its weight in gold. Clear, illustrated instructions lead you step by step through a complete, easily understood MODERN SERVICING EDUCATION that can equip you for fast, accurate service on even the most complicated jobs. Endorsed by service experts everywhere. Used by leading schools. Unsurpassed for home study. "Borrow" it for 5 full days on our 5-DAY MONEY-BACK GUARANTEE PLAN. You be the judge!

1300 pages
706 illus.
766 different subjects!

INSTRUMENTS! TROUBLESHOOTING! REPAIR!

MODERN RADIO SERVICING shows how to analyze circuits scientifically; how, when and where to use all types of test instruments; how to test, repair and replace components; how to make parts substitutions; how to handle every phase of radio-electronic repair work by MODERN methods.

HANDY SERVICE "GADGETS"



HOME RADIO GADGET—Spots 400 different home receiver troubles—tells what tests to make—suggests how to repair the set. Only 50c

AUTO RADIO GADGET—Indicates 444 special auto radio troubles in all possible sources for 11 common trouble symptoms. Only 50c

5-DAY MONEY-BACK GUARANTEE

Dept. RC-97, Murray Hill Books, Inc.,
232 Madison Ave., New York 16, N. Y., U.S.A.

Enclosed find \$..... for books checked, or send C.O.D. (no foreign C.O.D.'s) for this amount plus postage. If not fully satisfied, I may return books within 5 days for full refund of my money.

RADIO TROUBLESHOOTER'S HANDBOOK, \$5 (\$5.50 foreign)
 MODERN RADIO SERVICING, \$5 (\$5.50 foreign)
 MONEY-SAVING COMBINATION: Both big books—over 2040 pages—only \$9.50 for the two (\$10.50 foreign)

HOME RADIO GADGET, 50c AUTO RADIO GADGET, 50c

Name

Address

City & Zone State

LEEDS *The house you have known for 25 years*

RADIO TRANSMITTER & RECEIVER APS 13

410-420 mc., light weight, fully enclosed; 30 mc. I.F. Complete with 17 tubes, including 5-6J6; 9/6AG5; 2/2D21; 1/VR105. SCHEMATIC supplied with each unit. Only **\$1195**



Wire wound general radio type Potentiometer, precision made laboratory 25 watt 100,000 ohms; 6" diam. Brand new..... **\$1.95**

300 ohm Twin Lead, indoor or outdoor cable, per 100 ft..... **\$2.95**

52 ohm Coaxial Cable RG/8U outdoor; per 100 ft..... **\$4.50**

0-1 MA 3" D.C. G.E. meter..... \$3.50
0-1 AMP 2" R.F. G.E. meter..... 2.45
500-0-500 microamps 4" W.E..... 3.75

OIL-FILLED CONDENSERS

2 Mfd 1000 VDC \$.79	16Mfd W.E. 400VDC \$.98
8 Mfd 1500 VDC 3.25	3x0.2Mfd 400VDC .96
2 Mfd 2000 VDC 1.75	2x0.1Mfd 600VDC .25
6.1 Mfd 7500 VDC 4.50	2 Mfd 600 VDC .48
2 Mfd 10000 VDC 17.50	10 Mfd 1500 VDC 3.50
.02 Mfd 8000 VDC .98	7 Mfd 330 VAC \$1.25

LOUDSPEAKER LS-6-C

Consists of P.M. Speaker, Microphone, Trumpet, with triggered gun grip handle and connecting cable. Brand new. **\$3.95**



Ohmite 50 watt adj 25 ohm Resistor..... .15
10 for..... 1.25
Ohmite Rheostats 50 Watt 25 ohms..... .39
25 Watt 15 ohms..... .25

Sigma Relay 2000 plug-in type 4Ma DC..... \$.95
R.F. Oscillator 68-74 MC. with 1G6ST Tube .50
Busman 8 AG 1/100 AMP Instrument Fuses, per doz..... .50

NEONS—While they last **CONTROL BOX FOR 522**
2 Watt Edison base \$.29 Transceiver—consists of 5
¾ Watt Screw or push button switches, 5
Bay WE pilot light assemblies
¾ Watt Bay or & lever switch, all
wire leads .08 mounted in metal box.
Brand new..... **\$1.25**

SCHWEIN—Free and Rate Gyro. Operates from 24 V.D.C. Special **\$5.00**

BC-645 TRANSCEIVER: 420-450 MC; complete with 15 tubes including W.E. 316A doorknob and conversion diagram. Brand new in original packing. Special **\$14.95**

NEW STOCK OF AMERTRAN TRANSFORMERS, POWER TRANSFORMERS

K-606; 117V 60 cy., 700 V.C.T. 120 **\$5.46**
MADC; 5V @ 4A; 6.3V @ 4.7A.....
K-602; 117V 60 Cy., 580 V.C.T. 50 **\$3.54**
MADC; 5V @ 3A; 6.3V @ 2.A.....
K-604; 117V 60 Cy., 700 V.C.T. 70 **\$4.08**
MADC 5V @ 3A; 6.3V @ 2.5A.....

FILAMENT TRANSFORMERS—K-416; 117V 60 cy.; 10 V.C.T. @ 8A, 7500 V. test..... **\$3.84**
K-404; 117V 60 cy.; 2.5 V.C.T. @ 10A, 7500 V. test..... 3.24

OUTPUT TRANSFORMER—K-292; For PP 61.6 AB1 PR1-6000 ohm. Sec. 4/8/15/250/500 ohm. 30 watts..... **\$6.54**

If not rated 25% with order, balance C.O.D. All prices F.O.B. our warehouse New York.

No order under \$2.00

We ship to any part of the globe

LEEDS RADIO CO.

75 VESEY ST., Dept. RCS
Cortland 7-2612 New York City 7

STATIC HUNTING

(Continued from page 29)

considerable area. Power-factor correctors (if used) tend to localize this by attenuating the noise. These correctors are subject to breakdown, too, and create interference when they do. Noise due to these sources is steady and of considerable volume, and the complainant generally thinks his neighbor has a buzz saw running. The noise source is sometimes difficult to locate. The car radio can be used to patrol the high-voltage line in most cases. The whip aerial should be used until the source is approached, when a marked increase in volume will be noticed. The loop should then be used to localize the source. When found, the power company is notified and the trouble is cured by the linemen.

Loose high-voltage fuses sometimes set up an arc in the fuse holder that can be heard by anyone walking nearby. Some of the more recent types of fuses developed for power-line use, however, have holders that eliminate this source of trouble. In any event, the power company should be notified and their linemen should effect the cure.

Loose connections on high-voltage wires are difficult to find, but require very little time if the line is patrolled as mentioned above. Here again, the power company is notified. Most connections to 2,400- and 4,100-volt wires are made with clamps that hold the 2 spliced wires together. These clamps work loose in time and the wires separate enough for a small arc to form and cause the racket. These clamps, called "Kearneys" or "bugs" by some linemen, are easily tightened to kill the noise. Let the power company tighten them, though! They are HOT and a long way from the ground.

Substation switching equipment causes very little trouble. When it does cause radio interference, however, it covers a wide area. By patrolling the line, reducing volume as you approach, and finally using the portable with the whip aerial, you can walk right up to it. Substations are fed by high lines that carry 60,000 or 110,000 volts. This current in turn, is stepped down at the substation to 2,400 or 4,100 volts which goes into the distribution system. Air switches or circuit breakers are used to control the various circuits. These cause little trouble unless improperly operated or maintained.

A short summary

Many types of radio interferences will be encountered. Not all are curable. However, a noise-reducing campaign will make a vast difference in radio reception in any locality and will also create much favorable publicity and increase business for any radio shop undertaking it. Installing noise filters on electrical equipment can be a source of considerable income. Radio receivers with faulty tubes and condensers are also used by many people, with the

(Continued on opposite page)

AMSCO SPECIAL

SERVICE KIT

Kit includes assortment of:

100 Resistors, ½ and 1 watt.	25 Connectors & Plugs.
50 Condensers, paper, mica, electrolytic and can.	10 Jacks (Phone) & Tip.
100 ft. Spaghetti, var. sizes.	12 Padder Condensers.
12 Knobs, round and bar.	12 Terminal Boards.
2 lbs. Hookup wire.	25 Ceramic Insulators.
20 Fuses.	2 Panel Lights (1 neon)
6 Volume Controls.	1 Screw Driver.
10 Tube Sockets.	1 Tube Puller.
1 lb. Hardware (screws, nuts, lugs, etc.)	2 Allen Wrenches.
12 ww resistors, 10 watt.	2 Panel Fuse Holders.
10 Switches, toggle, gang, and rotary.	4 Blinding Post Strips, and many other valuable items.

Your Cost **\$9.95** Complete

FREE—"Experimenter's Kit" "1 Pr. Head-phones" or "1 tip mike" with first 500 orders.

Write for our catalog.

AMERICAN SALES CO.

1811 W. 47th St. Chicago 9, Ill.

TRANSMISION

KITS & PARTS

FOR PRICES & COMPLETE DETAILS
WRITE OR VISIT -

RADIONIC EQUIPMENT COMPANY

DEPT. 109T TRIBUNE THEATRE ENTRANCE
170 NASSAU ST., N. Y. 7, N. Y. Worth 2-0421
CABLE "CHANSLOR"

RADIO MEN

Write for Bargain
Catalog of Radio Parts
BUYERS' SYNDICATE

786 Carew St. Springfield, Mass.

TUBULAR ELECTROLYTICS

Fresh stock Fully guaranteed

20 mfd. 150 V. 10 for \$1.79
20-20 mfd. 150 V. 10 for 2.49
8 mfd. 450 V. 10 for 1.85

Postage extra, 25% deposit on C.O.D.
Write for our free bargain lists featuring "AMERICA'S BEST BUYS"

POTTER RADIO CO.

1312-1314 McGee St. Kansas City 6, Mo.

LCETI

Krypton lamps 9 times as bright as the sun are being installed by Westinghouse at New York's new Idlewild Airport. The lamps, only 4 inches long, emit a light which can be seen through 1,000 feet in the thickest fog.

blame for poor reception being placed on innocent neighbors and power companies. When the repairman arrives, not to fix the radio, but to eliminate the noise at the SOURCE, he has the customer's admiration and respect. Equipment to find the trouble need not be elaborate or expensive. The proper equipment and a sympathetic attitude toward the complainant will work wonders. And if the noise is found and cured, you can be sure that you will be the one to fix the radio when it does need repairs.

Every attempt should be made to find and cure the trouble at the source. In extreme cases, shielding and special aerials may have to be installed. It will be found, however, that this will never be as effective as finding the actual cause of the interference and curing the trouble itself.

LOW-PRICED FM TUNING UNIT

(Continued from page 27)

with No. 8 copper bus bar rigidly mounted so that there is no vibration under normal operating conditions. The oscillator uses an electron-coupled circuit similar to that commonly used with a 6SA7 or equivalent tubes. R.f. chokes in the filament leads of the r.f. amplifier and oscillator-mixer confine r.f. currents within these circuits and help to stabilize the set. The 3-gang tuning condenser is especially rugged, with widely spaced, heavy copper plates. The oscillator coil is silver-plated with its high-frequency padder and trimmer temperature compensated. The low-frequency padder is an aluminum disc with a screw-driver adjustment to vary its distance from the coil. This varies the effective inductance.

The mixer is coupled to the first of two 10.7-mc i.f. stages through a 2-winding permeability-tuned transformer. No limiter stages or a.v.c. are used. The audio output of the ratio detector feeds through a de-emphasis network to terminals 6 and 7 on the strip on the

new

CONCORD Radio Catalog

RADIO PARTS • RADIO SETS
RECORD CHANGERS • PLAYERS
HAM GEAR • AMPLIFIERS • TESTERS

This is it—the new 1947 Concord Catalog—a vast, complete selection of everything in Radio and Electronics—thousands of items available for IMMEDIATE SHIPMENT from CHICAGO or ATLANTA—hundreds now available for the first time—featuring new, latest 1947 prices. See new LOWER prices on RADIO SETS, PHONO-RADIOS, RECORD CHANGERS, RECORD PLAYERS, PORTABLES, AMPLIFIERS, COMPLETE SOUND SYSTEMS, TESTERS. See latest listings of standard, dependable lines of radio parts and equipment—tubes, condensers, transformers, relays, etc. Mail coupon for FREE COPY—NOW!

TIME PAYMENTS: Write us for details of time payment plan on Communications Receivers, Amplifiers, Test Equipment, Radios, Phono-Radios, etc.

CONCORD
RADIO CORPORATION
LAFAYETTE RADIO CORPORATION
CHICAGO 7, ILL. ATLANTA 3, GA.
901 W. Jackson Blvd. 265 Peachtree St.



free

Mail COUPON TODAY!

Concord Radio Corporation, Dept. RC-97
901 W. Jackson Blvd., Chicago 7, Ill.
Yes, rush FREE COPY of the comprehensive new Concord Radio Catalog.

Name.....
Address.....
City..... State.....

rear of the chassis. Audio output level is about the same as a high-output crystal phono pickup. If it is necessary to disconnect a phono pickup to connect the tuner to the radio or amplifier, connect the "hot" side of the pickup to terminal No. 5 and the low side to No. 4. The pickup is automatically connected to the phono input terminals of the receiver or amplifier through a switch when the tuner is off. The switch is ganged to the on-off switch.

The set is delivered with the internal antenna connected. In this case, a jumper is connected across terminals 1 and 2. This connects the tap on the antenna coil to one side of the power line through a blocking condenser. R.f. chokes in the line isolate the primary of the power transformer from the section of the line used as an antenna.

Servicemen will welcome the complete servicing and aligning data supplied in
(Continued on page 81)

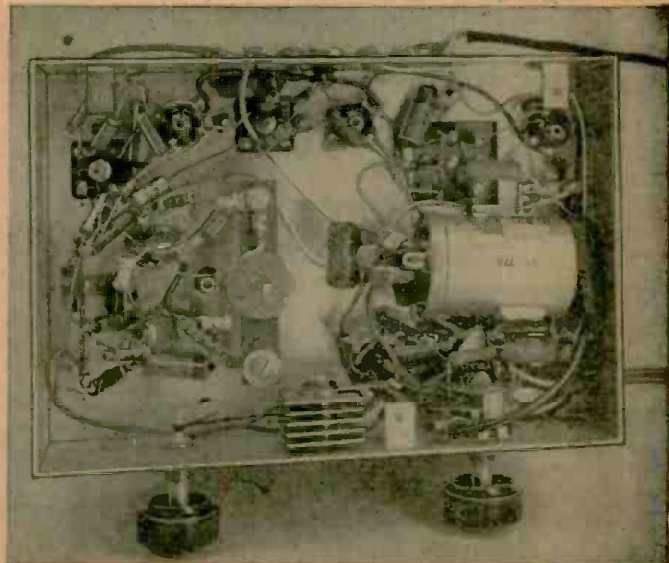
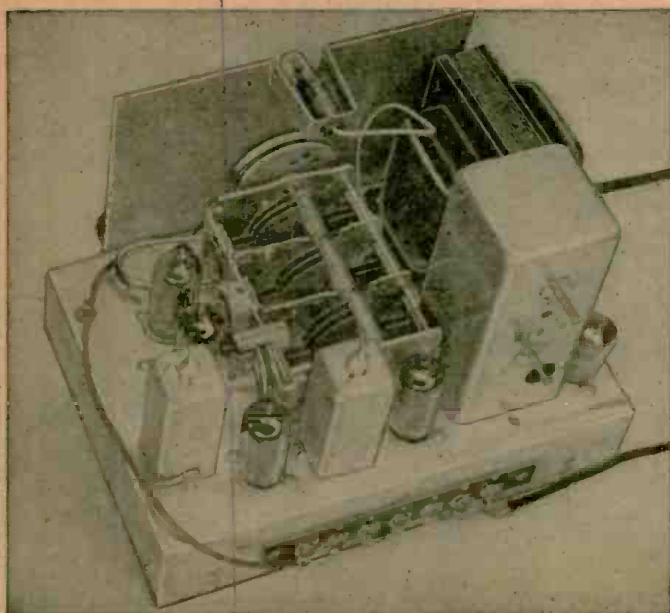

Left—Large can at lower right is the ratio detector transformer. Above—Under-chassis view. Round disc in center is osc. trimmer.

FOR BETTER BUYS SEE HIGHBRIDGE

BRAND NEW 7EP4

Individually packed — in original cartons—Guaranteed \$19.50

WESTERN ELECTRIC INPUT TRANSFORMER

Video core type; impd. ratio between windings: 1-2, 3-4, 5-6, in parallel 50-900 ohms; Freq. range 10 KC to 2 MC; made for set AN/APQ-13; Electrostatic shield between windings, oil filled; 5 1/4" diameter, 5" high, wt. 5 lbs. \$1.95

KS-9524—Transformer Pri. 115 V—60 cycles. Sec. #1—450 V @ 30 MA C.T. Sec. #2—6.4 V. @ 1250MA. Rectangular metal case. stud mtg. solder eyes—approx size 3 1/16 x 2 5/16 x 3/8 with standoff 4% No. T2G-97 \$1.95

I.R. #7313 Filament Trans. 115 V—50-60 cycle. Sec. #1—27 KV @ 4.3 amps No. C.T.—Sec. #2—5.1 V. @ 3 amp C.T.—Sec. #3—6.4 V. @ 3 amp No. C.T.—Sec. #4—5.1 V. @ 3 amp C.T.—Sec. #5—2.6 V. @ 3.5 amps No. C.T.—Rectangular metal case, solder post terminals; Mtg on porcelain standoffs; stud mtg. size 5/8 x 4/8 x 5/8 with standoffs 6%. T2E-88 \$4.95

High voltage transformer with Glass Standoffs. Pri. 115 V. A.C.—400 cycle—Sec. 5700 V. Rectangular; approx. size 6 1/4 x 4 1/4 x 3/8 with standoff 7 1/4"—13 MILS D.C. G.E. K52J652-G2. T3F-7 \$3.95

Power-Fil. Trans.; "GE" #7467899; Pri. 115V. 60 cyc.; Sec. 1.113 tapped at 1.0V.; 3V. & 7.5V. @ .05 amps; 7 lug terms; on ceramic bushings; plated steel case; size 1 1/2"x2 1/4"x2 1/4"H. T2E-17 \$1.10

Plate-Trans.; Pri. 115V.—400 cyc.; Tapped pri. Sec. 780/875/900V.; (Variable w/Pri. volt.); @ 410 Ma. C.T.; metal case; mtg. holes; lug terms.; wt. 4 lbs. 4"ozs.; size 3 1/4"W.x3"D.x3 1/4"H. "WE" #SP-1035. T3F-3 \$0.99

Plate & Fil. trans; Pri. 115-400 cyc; 2 Sec.; #1-0-560-1100V.-50 ma; #2-2.5V.-5 amps. NCT; w/electrostatic shield; open frame mtg.; lug terms; wt. 2 lbs.; size 3 1/4"W.x2 1/4"D.x3 1/4"H.; "Acme" #KS-9336. T4G-2 \$1.10

Power-Fil. Trans. Step-down; "GE" type #68G779; Pri. 55V.—60 cyc.; Tapped @ 40, 20, 4 & 2V.—60 cyc.; Sec. #1, 22V. @ 15Ma.—C.T.; Sec. #2, 22V. @ 15 Ma. C.T.; Rectangular metal case; approx-size 3 1/4" x 2 1/4" x 3 3/8" porcelain standoffs. T2A-1 \$1.49

AF video trans.; input; 3 windings; 0.5 ohms ea. impd.; metal case; bottled; 1-11/16" x 2-17/32" x 2-19/32"; "WE" #KS-9628; (max. audio oper. level 1/10W.; turns ratio pri. to sec. 1 to 1; freq. 10Kc to 1Mc.); 6 lugs; stud mtg. P/O indicator. ID-56/APQ-7 \$1.10

Fil-Trans. "GE" #7467890-1; 41.2V-6 amps; 380 to 2400 cyc.; rectangular; with 4 mtg. screws; 5 lug terms; porcelain standoffs; size 3 1/4"x2 1/4"x1 1/4"H. T4E-1 \$0.69

Audio osc. trans.; 400 cyc.; Pri. to 1st Sec. 1:0.4; #2, sec. 1:0.1; size 1 1/4" dia. x 1 3/8" L.; 4 lug terms; 3 screw lugs; #ES-692327. \$0.39

RADIO TRANSMITTER AND RECEIVER APS 13

Light weight air-horn radar system, radio transmitter and receiver APS-13; tube complement 5-6J6; 9-6AG5; 1-VRI05; 2-D21; unit is brand new, complete with tubes; the tubes alone are worth more than this low price of only \$12.50

Working instructions for Wireless set #19 Mark II \$0.29

All Prices FOB New York City, N. Y.

HIGHBRIDGE RADIO - TELEVISION & APPLIANCE CO.

343 CANAL NEW YORK 13, NEW YORK

ENGLISH REPAIR METHODS

(Continued from page 56)

by feeding it directly into the receiver under service, or by placing it at some distance from the aerial and picking up the radiation.

Kits are being manufactured which consist of a multipurpose tester and a supply of tubes, condensers, and resistors all built compactly into one case together with a small 3-inch 'scope. This kit is taken by the service engineer into the customer's home for a radio check-up.

In England radio manufacturers are very jealous of the reputation of their sets. They will not give a franchise to a radio dealer unless that dealer employs service engineers who have been trained in the manufacturer's own factory. This is especially important from the standpoint of television. All the television manufacturers are now calling service engineers in for a course about 3 weeks in length.

Television receivers in England have been radically redesigned and employ new noise-limiting circuits which eliminate considerable man-made interference. An attempt is being made to curtail the number of tubes. It is hoped to design an 8- or 10-tube television table model for immediate sale. Again, considerable experimentation with the high-voltage sections of television receivers is under way in an effort to safeguard the radio service engineer who has to work with them.

Many owners of prewar television sets are now rushing them to the dealers to have them rejuvenated. After 6 years' storage in the customer's home, a very high percentage of replacements is necessary. In most cases the electrolytic capacitors have long since deteriorated. Moreover many television receivers have gone through "blitzes" and need attention badly.

In particular, radio service engineers are working out new test equipment for television units which will enable them to dispense with complicated antennas, so that television sets may be serviced in the shop under conditions more nearly approximating those to be found in the customer's own home.

Summing up, English repairmen are keeping busy and very much abreast of the times.—E.A.C.

PEN-OSCIL-LITE

Extremely convenient test oscillator for all radio servicing; alignment • Small as a pen • Self powered • Range from 700 cycles audio to over 800 mc/cycles a.f. • Output from zero to 125 v. • Low in cost • Used by Signal Corps • Write for information.

GENERAL TEST EQUIPMENT

38 Argyle Ave. Buffalo 9, N. Y.

SHANEY'S
New
20 STEPS to PERFECT
AMPLIFICATION
SEND
3c STAMP
FOR POSTAGE
AMPLIFIER CORP. of AMERICA
398 Broadway, New York 13, N. Y.

Are You Missing
The Best Values
In Radio?
SEND FOR THIS NEW
FREE
CATALOG NOW!

Here's the handiest, most complete radio buying guide in America. Contains over 10,000 items of nationally known quality. Brings to your door step the world's largest and most complete stocks of radio and electronic equipment. Save time, work and money — send for your free copy.

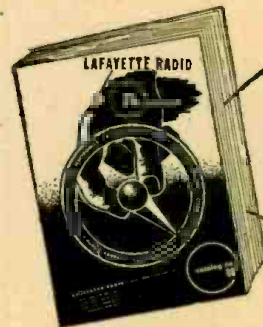

MAIL COUPON
BELOW FOR
144
VALUE-PACKED
PAGES

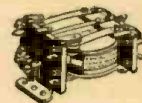

PARTS. America's biggest stock of quality parts and equipment. Everything for hams, soundmen, engineers, servicemen, experimenters. All leading makes at economy prices.



RADIO SETS. The new Lafayette Catalog is a regular parade of all the latest 1947 models, including phono. radios, portables, communication receivers. Latest styling—outstanding performance—wonderful values.



P.A. Sound systems for every type of public address installation. Complete listing of amplifiers, microphones, speakers, accessories. Many new developments listed for the first time.

Lafayette Radio

RADIO WIRE TELEVISION, INC.
100 Sixth Ave. • N. Y. 13
110 Federal St. • Boston 10
24 Central Ave. • Newark 2, N.J.

Paste Coupon on Penny Post Card

LAFAYETTE RADIO, Dept. J.J.-7

100 Sixth Ave., New York 13, N. Y.

Please send new Lafayette Radio Catalog at once.

Name.....

Address.....

City.....Zone.....State.....

RADIO INVENTIONS WANTED:

The National Inventors Council has released a list of 25 inventions wanted by the Army, Navy, and Coast Guard. As not all the 25 inventions pertain to radio, we are listing below only those which we believe may have some connection with radio development:

High-Voltage Rectifier

Rectifier tubes are wanted to stand a peak inverse voltage of 10,000, 20,000, 30,000, 40,000 volts, requiring a filament current of not over 100 milliamperes and capable of delivering approximately 300 microamperes. The tubes, which should be light in weight and of minimum size, are to be used to operate an electron tube yielding a bright image. A low-voltage, battery-vibrator-type power supply is to be used.

Roll Indicator

A recorder of the amplitude and period of rolling is needed to provide accurate information on the stability of vessels under various conditions of loading and while the vessel is under way at sea.

Fog Detector

A device is wanted for an unattended light vessel to start the fog signal when visibility has been reduced to the danger limit. The detector should not respond to ordinary fluctuations of light by day or night.

Miniature Radio Sender

To be used on life-saving flotation equipment as an aid in locating the shipwrecked by means of a signal to aircraft and surface vessels.

Fume Detector

There is an urgent need for a combustible gas alarm as a warning device against bilge explosions on gasoline-engine-propelled boats.

All suggestions will be studied by the National Inventors Council and those approved will be sent to the proper branch of the Army, Navy or Coast Guard. More detailed information can be obtained by writing to the National Inventors Council, United States Department of Commerce, Office of Technical Service, Washington, D. C.

Radar works for the weatherman. It responds to electrical disturbances within clouds thus aiding in weather predictions. It also tracks weather balloons and guided missiles used in weather research.

SILVER AM PLUS FM 90 KC-210 MC



OVERWHELMING ENTHUSIASM greeted first shipments of Model 906 Signal Generator . . . most of which seem to have gone into manufacturers' laboratories, so good is it. Nowhere else . . . at any price . . . can you buy its equal. Check these features: eight ranges dial calibrated to 1% accuracy . . . 90 kc/170 mc. AM . . . 90 kc-210 mc. FM . . . built-in 0/500 kc. FM sweep . . . variable 400 amplitude modulation . . . less than 1 microvolt to over 1 volt metered output . . . resistive and capacity-insulated output strays so low it's in the \$500.00 and up laboratory class. Yet price is only \$99.50 net.

"VOMAX"

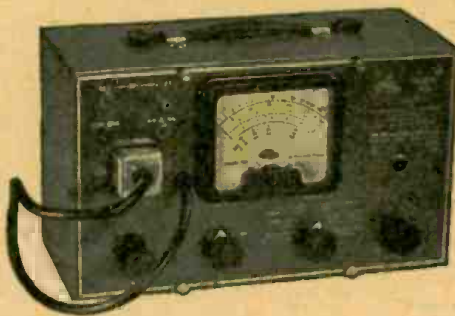

NEW PENCIL-THIN R.F. PROBE

Now "VOMAX" is equipped with new, pencil-thin, flexible 5-inch r.f. probe extension plus ground clip-lead. It will reach any point in the tightest midget receiver . . . will even bend around corners! This exclusive new SILVER development maintains "VOMAX" as the finest, most complete meter you can buy . . .

Overwhelmingly, acceptance proves "VOMAX" to stand head and shoulders above any other meter — at any price. It is unbeaten . . . even by its copyists . . . for accuracy,

for d.c., a.c., o.f., i.f. and r.f. voltage ranges . . . as it is for current and resistance ranges . . . for frequency range . . . and for that astronomically high input resistance so necessary to effective AM, FM, and TELE receiver servicing. Price is still only \$59.85 net . . . r.f. probe extension kit \$35.

**ELECTRONIC
VOLT-OHM-METER**

\$11.85

110 VOLTS AC 20 RANGES

0/5/10/50/100/500/1000/5000
volts DC and AC. 0-1,000,000,000
ohms in six overlapping ranges. Sensi-
tivity: over MILLION OHMS per
VOLT on 5 volt range.

Complete kit includes all component parts, tubes,
punched and drilled chassis and beautifully enameled
panel. Easily assembled and wired.

Special slideback circuit developed during war
by scientist at the California Institute of Technol-
ogy gives amazing sensitivity and flexibility while
completely eliminating necessity of batteries and ex-
pensive meter. Each instrument is individually cali-
brated. Dial scale over nine inches long!

In addition to performing the usual volt-ohm
functions, this instrument easily measures these
voltages: SUPERHET OSCILLATOR, AVC, AFC,
TRUE GRID BIAS AT THE GRID, BIAS CELLS with-
out affecting the circuit. Measures the exact leak-
age resistance of INSULATION, TUBES, CON-
DENSERS. It can be used with a signal Generator
for SIGNAL TRACING.

STERLING ELECTRONIC COMPANY
BOWLING GREEN, KENTUCKY

NEW CATALOG. Mail penny postcard for complete catalog, these and other SILVER top-dollar test instruments they are the backbone of modern servicing. New transmitters, receivers, exciter, MICROMATCH, pre-tuned frequency multiplier are among the new! See them at your jobber.

OVER 36 YEARS OF RADIO ENGINEERING ACHIEVEMENT

McMurdo Silver Co., Inc.

1249 MAIN ST., HARTFORD 3, CONNECTICUT

GET THIS FREE CATALOG NOW



ALL THE BEST
BUYS IN RADIO,
HAM EQUIPMENT
AND P. A.
SYSTEMS.

SEND FOR YOUR COPY

of this new free book designed to save you money. Select the new Lafayette radio or famous-make ham equipment you want—at thrifty, low Lafayette prices. Do as thousands today are doing—make the big FREE Lafayette Catalog your buying guide. You save valuable time when you “shop” by mail. And you save real money on everything you buy. Every item in the great Lafayette Catalog is value-priced! Don't be without this book another day. It's FREE—just mail the coupon for your own copy. See what you get!

YEAR'S BEST P. A. BUY
Lafayette 8-watt Indoor System
Here's Lafayette's value-leader in the low-power field. If you sell P.A.—this system will go like hotcakes. If you use P.A.—it's your chance to save a lot of money.
MODEL 7015—Complete unit includes: Model 708 8-watt amplifier, complete with tubes. Amplifier has separate mike and phono inputs, output impedances of 8, 15 and 500 ohms. Ten-inch PM speaker. Fabrikoid wall baffle. Crystal mike and stand with 7½-foot cable with end connector. Twenty-five-foot speaker cable. Operates on 110-120 V. A. C., 60 cycles, 65 W.
COMPLETE READY TO OPERATE
—Your Cost Only \$44.60

LAFAYETTE Radio

RADIO WIRE TELEVISION INC.

100 SIXTH AVENUE, NEW YORK 13, N. Y.

170 Federal St., Boston 10 ☆ 24 Central Ave., Newark 2, N. J.

LAFAYETTE RADIO, Dept. J.J.-7
100 Sixth Avenue, New York 13, N. Y.
Please RUSH big free radio catalog.
Enclosed is Check Money Order for PA System
Name _____
Address _____
City _____ Zone _____ State _____

PRINTED RADIOS

(Continued from page 17)

printed grid-leak resistors, so now engineers are beginning to print on the chassis certain resistors, using special inks for the process. It is conceivable that in due time most of our resistors on our radio chassis will be printed instead of being three-dimensional.

Inductors also are simple to print. We already have printed or plated helices, which work just as well, if not better, than three-dimensional ones.

It seems quite possible that actual tuning will be done in the near future, where two spiral line inductances are printed on two separate thin insulating sheets. Then tuning can be accomplished by sliding one sheet over the other. A somewhat similar method was used many years ago in our old-time variometers.

It is conceivable that cheap radios of the future will have some such variometer-tuning which will entirely do away with variable condensers.

Built-in antennas can be easily fashioned in the above described manner simply by printing or plating the antenna spiral inductance.

This brings us to the capacitors, or condensers, used in radio sets. Is it possible to use printed capacitors in the radio set of the future? We believe so, particularly with the smaller capacitors.

The manner in which radio condensers are mass-produced today is probably as efficient and economical as can be done by the plating or printing method. Yet there may be exceptions here, too, particularly with those condensers which must take up a minimum of room. No matter how thin you roll aluminum or tin foil (as used in present-day condensers), it still takes up quite a bit of room, particularly where the capacity of the condenser is high. Perhaps it will be more economical and practical to print on the dielectric such as wax-paper, with a conducting link. Then after the condenser is rolled up in the usual fashion, it will be much thinner than the metal-foil type. (Incidentally, the Germans perfected a metal sprayed paper for condensers, during the war.) Printed condensers of this type probably will be used sooner or later in our pocket radio sets where even a 64th of an inch thickness of a component becomes a big factor. Such a condenser also will have its uses in many military radios, pocket transceivers, proximity-fuse radios, miniature radars, etc.

The matter of connecting the various components to the printed components has taken much ingenuity to solve. When, for instance, your chassis with its printed connections, its printed inductances, and its printed resistors are ready for final assembly, it is still necessary to make further connections such as the radio tubes. The tube prongs must be connected in a positive manner to the printed or plated connections. This problem, however, has already been

SEPTEMBER LEOTONE SPECIALS

MINIATURE ALNICO V MAGNETIC PHONE UNITS (HS-30 headset replacement) 75 ohm impeda. Wide freq. response & sufficient volume for use as: PM or Pillow Speaker, Dynamic or Contact Mike (using below Ouncer Input) or Hearing Aid unit. 3/4" O.D. 1/2" deep, each \$3.39

UTC "OUNCER" INPUT TRANSFORMER
3/4"x1-3/16" Dynamic mike or low impedance pickup up to grid .49
12 for 5.00

4 TUBE SERVO AMPLIFIER (2 — 7CS, 7F7, 7Y4) 110V, 400 cycle. (See July, '47 Radio-Craft for diagram showing conversion to phono & mike amplifier) Black crackle finish case & slide-in chassis. 8 3/4" x 4 1/2" x 3 3/4" Less tubes 2.49

PE-157 POWER SUPPLY. Incomplete unit, but a "gold mine" of relays, switches, jacks, selenium rect. chokes, etc. Portable hinged lid metal case. (6"x9"x1 1/2") OD crackle finish. PLUS descriptive 173 p. Tech. Manual. Shpg. wt. 20 lbs. 2.49

ALNICO MAGNETS

#1—Bar, 8 1/4"x5/16"x1/8"	5.39
Bar, 1 1/2"x3/4"x3/8" max. length. Per inch	.12
#2—Face 1 1/2"x3/4"x7/8" high	.98
#3—Heavy duty bar, 2 1/2"x1 3/8"x5/16"	.39
#4—Face 3/4"x3/4"x3/8"	1.35
#5—Polished, 1/2"x9/16"x3/4" high	3.00
#6—Polished bar, 9/16"x1/2"x3/8"	20 for 1.35
#7—ALNICO V, h'shoe, poles 3/8" sq. 1 1/2" high	.75
#8—ALNICO V, h'shoe, poles 1"x1 1/2"x3/4" high (shpg. wt. 4 lbs)	5.95
#9—Bar, 1 1/2"x3/4"x3/8" O.D. 1 1/2"	.35
#10—Polished Block, 3"x2 3/4"x1 1/2"; mag. notched wide or narrow sides (wt. 3 lbs.)	2.49
#11—Circular, 1 1/16" O.D., 9/16" I.D., 5/16" deep	.49
#12—Rnd bar, 1/2" O.D. x 7/16"	.12
#13—Rnd bar, plshd, 1/4" O.D. x 4"	.35
#14—Rnd bar, plshd, 3/8" O.D. x 2 1/2"	.59
#15—Rnd bar, plshd, 3/8" O.D. x 3 3/4"	1.49
#16—Polished block, 3/4"x3/4"x3/8"	.39
#17—Circular, plshd, 2 3/8" O.D., 1 3/8" I.D., 1 1/8" deep	1.65
#18—H'shoe, extremely powerful. Poles 1 5/8"x1 3/16". Polished. 2" high	1.49

DPTD Relay (Allied) Rated 10amps @ 115 V. AC. 1/2" contacts. 18-28V. DC. 230 ohm coil 1"x1 1/4"x2". \$9 RG-5 COAX. 5/8" diam. 4 ft. lengths with two PL-250 connectors39

SERVICEMEN'S KITS

#1—R.F. Antenna & Osc. coils. 10 asstd.	.98
#2—Speaker Cones; 12 asstd. 4 to 8" moulded & free-edge (magnetic incl) Less voice coils	2.00
#3—MOLDED BAKELITE CONDENSERS. 50 asstd. 00001 to 100mf. 200-600WV.	2.95
#4—TUBULAR BY-PASS CONDENSERS. 50 asstd. .001 to .25mf. 200-600WV.	2.49
#5—Waf. for Sockets; 12 asstd. 4 to 7 prongs	.25
#6—Shield Cans; 15 asstd. for coils, tubes, transformers, etc.	1.00
#7—Alca Padders & Trimmers; 15 asstd. incl. multiple & ceramic base types	.69
#8—Volume & Tone Controls; 10 asstd. wire-wound & carbon. Less switches	1.49
#9—Wire-wound Resistors; 13 asstd. ohm. ages, 5 to 20 watts	.98
#10—Bakelite Coil Forms; 18 asstd. popular sizes up to 3" diameter	.98
#11—High Resistance Units; 25 asstd. carbon & wire. 25K to 5 megohms	.49
#12—Metal Cased By-Pass Condensers. 10 asstd. paper-wound, multi-section	.49
#13—Resistor Assortment; 20 carbon & wire-wound; 1/3 to 3 watts	.49
#14—RADIO CEMENT SOLVENT. 1 oz. each of all-purpose cement & thinner. With brush	.69
#15—Shaft Extenders, Reversers; 15 asstd. 10 asstd. popular types	1.29
#16—Spring Assortment; 60 asstd. compression & expansion for dials, switches, relays, etc.	.98

TUBES: Perfect condition, but not in sealed cartons. Every tube guaranteed 90 days.
#17, 68A7, 68K7, 12SA7 or 12SK749
#18, 6A3, 6AU6, 7A7, 7C5, 7C6, 7Y4 or 50 Brand new RCA UX-200 tubes in sealed cartons. \$1.00
Ideal triode detector, 8 for59
Telegraph Key & 8V. Buzzer (Western Electric) Gap & tension adjust. 1 1/2" bakelite base 1.25
Key only (platinum contacts)49
EXPERIMENTAL TUBES. 20 asstd receiving types for testing, research, etc. Full tested RADIO HARDWARE TREASURE. An indispensable assortment of approx. 1000 screws, nuts, lugs, washers, etc. 49

SPECIAL!!—GIANT "GRAB-BAG" RADIO PARTS KIT. A real buy for the Serviceman, Amateur or Experimenter. 15 FULL QUANTITIES of resistors, condensers, transformers, wire, speaker repair parts, hardware, etc., etc. An amazing value at 1.98

PROMPT SERVICE ON ALL SPEAKER & PHONO PICK-UP REPAIRS
Minimum Order \$2.00—20% Deposits on All Orders. Please Add Sufficient Postage.

LEOTONE RADIO CO.
MAKERS OF CONES AND FIELD COILS
65-67 DEY STREET, NEW YORK 7, N. Y.
WORTH 2-0284-5
12,000 SQ. FT. OF RADIO PARTS

solved and new improvements are being made right along.

Special brass ferules with flanges are used to make positive connections that need not necessarily be soldered. These brass ferules, or fingers, made of a hard springy brass, that is always under tension, are forced through certain prefabricated holes. When these brass fingers, or clips, are then machined into place they make a permanent and excellent contact with the plated or printed strips. Then when the radio tube is inserted in the usual manner there will be no loose connections.

It has been found that printed resistors do not change appreciably over a long period of time. The expansion and contraction coefficient is very small and there is practically no deterioration. All of this can be further safeguarded by placing a final insulating lamination on top of the printed or plated connections so that all dust is kept out. Now the chassis with all of its printed resistors, components, and connecting strips is hermetically sealed; no moisture or dust can get in between the two sheets.

This can be further improved if the set is to work in the tropics. For instance, by sealing the edges off with some special compound the entire chassis is made moisture- or water-proof.

Why is this new radio development so important at present? It is of a purely economic nature. Radios are selling today for more than 50% above their price before the war. And it is axiomatic that the more labor is expended on a radio receiver the more expensive it will be. In the United States, as everywhere else in the world today, it is not the cost of the materials that makes the price of the radio set. It is the high cost of labor which is many times that of the materials. Hence, it can be seen how important the new printed radio development is and how anxious the radio industry is today to convert to this type of radio as fast as possible.

Not only will the printed radio receiver be much lower in price, but it is an ideal article for mass production under present-day conditions.**

There is another, even more important consideration, i.e., the servicing of radio sets. Today when a radio serviceman services a receiver and locates the trouble it becomes a matter of labor to put the set into operating condition again. Sometimes when it is difficult to locate the trouble it may take several hours to find it, for which time the serviceman must charge. There may be troubles such as intermittent contacts and other "bugs" which makes it most difficult to locate the trouble.

Now let us consider the printed radio of the future and note how it will be serviced. Forward-looking engineers already have visualized a radio chassis with all the major components except the loudspeaker, tubes, etc. *The entire chassis will be composed of a few in-*

**See also article "Why No 'Postwar' Radios?" by H. Gernsback, August, 1946 RADIO-CRAFT.

Get All 10

RADIO-CRAFT LIBRARY SERIES

These Books Keep You On Your Toes!

All ten books in this outstanding 1947 series of technical radio books are now off the press. Here are a total of 640 pages of downright practical knowledge to help you keep punching away at the unknown factors of radio until you have mastered them. Every one of the 10 is worth many times its 50c price if you will just apply a small portion of the information gained to your daily work. You'll be glad you have the complete set handy—within easy reach for quick reference—whenever you are trying to work out a particular problem in construction, testing or servicing. You'll like the easy-to-read type—the clean-cut printing—the smart, modern, flexible covers, and the great number of illustrations. They all help to make learning a pleasure. Order as many as you need today—better still, make it all 10.

\$5.00 SET OF 10

ONLY 50c EACH



No. 29—**HANDY KINKS AND SHORT CUTS.** A carefully edited compilation of time savers. Kinks on Antennas—Power Supplies—Test Equipment—Servicing—In the Shop—Phonographs and Amplifiers—Coils and Transformers—Miscellaneous Subjects.



No. 30—**UNUSUAL PATENTED CIRCUITS, 1944-1946.** A gold mine in new book-lets! A selection of unusual circuits, many a result of wartime research—of great value to anyone interested in electronics. Control Circuits—Detectors and Amplifiers—Power Supplies—Miscellaneous Circuits—Foreign Circuits.



No. 31—**RADIO QUESTIONS AND ANSWERS.** Answers to most frequently asked questions. Clear circuit diagrams. Amplifiers—Receivers—Transmitters—Meters and Test Equipment—Interphones—Power Supplies—Phonograph Amplifiers—P.A. Systems.



No. 32—**ADVANCED SERVICE TECHNIQUE.** An up-to-date collection of information for the advanced serviceman: Visual Alignment—Tracking Problems—Negative Feedback—Tone Control Circuits—Adding Microphones to Sets—Matching Loudspeakers—Remote Juke Boxes—Servicing Record Changers—Hum Elimination—FM Servicing.



No. 33—**AMPLIFIER BUILDER'S GUIDE.** Invaluable for the designer and builder of audio equipment. Tells how to build a wide variety of amplifiers with power outputs ranging from 8 to 30 watts. Detailed design information on: Push-Pull—Phase Inversion—Bass and Treble Boosters—Volume Expanders—Resistance Coupling—Internal Feedback.

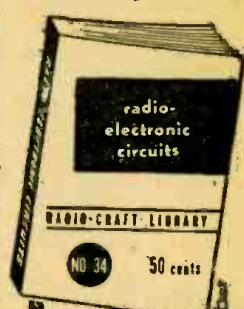

No. 34—**RADIO-ELECTRONIC CIRCUITS.** An extensive collection of circuit diagrams, with brief, to-the-point descriptions of each, including: Intercommunications Systems—Power Supplies—Balancing Circuits—V.T. Voltmeters—Amplifiers—Receivers—Phono Amplifiers—Short Wave Adaptors—Electronic Relays.



No. 35—**AMATEUR RADIO BUILDER'S GUIDE.** For the "ham" who builds his own. Practical, down-to-earth, it tells how to Build: A 2 Meter Band Acorn Tube Set—Miniature Communications Receivers—Long Lines Transmitter—Beginner's Transmitter—Preselector—Rotary Beam Aerial—Power Supplies—and other ham gear.



No. 36—**RADIO TEST INSTRUMENTS.** A MUST for every radio man. This latest book on building test equipment places emphasis on practical construction of: Signal Tracers—Capacity Meters—Portable and Bench Multi-checker—Signal Generators—Tube Checkers—Electronic Voltmeters—and many others.

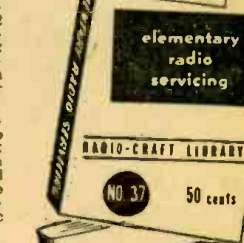

No. 37—**ELEMENTARY RADIO SERVICING.** For the radio man who knows little about servicing. How to get started, and even more important, how to keep going; Planning the Service Shop—Equipping the Shop—Systematic Circuit Checks—Signal Tracing Methods—Servicing the Mid-Get—Soldering—Servicing Volume Controls—How to Service Speakers.



No. 38—**HOW TO BUILD RADIO RECEIVERS.** This book contains a sufficient variety of sets to appeal to every radio fan. Includes: Short-Wave, Broadcast, Portable, A.C. Operated, Miniature and Standard Receivers. Complete coil-winding data is furnished.

RADCRAFT PUBLICATIONS, Dept. 97
25 West Broadway, New York 7, N. Y.

See Your Dealer
If He Can't Supply You, Use Coupon

Send me the volumes (50c each, postpaid) checked. My dealer is unable to supply. All 10 Books

I enclose \$..... 29 34

Your Name 30 35

Address (Print Clearly) 31 36

Dealer's Name 32 37

Address 33 38

RADIO AND ELECTRONIC KITS FOR ALL PURPOSES

RADIO KITS

All kits have been designed by a reputable radio engineer with a background of many years experience with some of the leading manufacturers in the radio industry. The kits contain all the required parts except wire and solder for their construction into an efficient working unit comparable with the best post-war type of units. The simplified diagrams furnished make it possible for any radio student experimenter, or amateur to construct these kits.

FIVE TUBE AC-DC SUPERHET KIT:

Furnished in a brown plastic cabinet of artistic design, cabinet size (9"x5"x6"). Variable condenser tuned with 2 double tune I.F.'s. Tubes used: 1-12SA7, 1-12SQ7, 1-35Z5, and 1-50L6 **PRICE \$12.45**
(Including 5 Standard Tubes)

SIX TUBE 3 WAY PORTABLE KIT:

For operation on 110 volt AC or DC and battery. Superheterodyne circuit. Full vision dial. High gain loop. Cabinet of Blue Aeroplane cloth finish, size 13x9-1/2"x7". Tubes used 1A7, 1H5, 3Q5, 117Z6 and 2-1N5 **PRICE \$13.75**
Not including tubes, Extra for kit of Tubes 3.75

SIX TUBE, 2 BAND SUPERHET KIT

Bands covered BC 650-1600 KC. Power supply 105-125V AC-DC. Full vision dial. Variable condenser tuned with two double tuned I.F.'s 455 KC. Walnut veneer wood cabinet **PRICE \$16.45**

PORTABLE ELECTRO PHONO KIT

Contains: A Portable Simulated leather covered wood cabinet, will take 12" records. An AC phono motor 110 V 60 cycles. A crystal pickup, A 5" "Alnico 5" P.M. speaker. A complete kit of parts (less tubes). Construct a 3-tube phono amplifier.

PRICE \$15.95

THREE TUBE PHONO AMPLIFIER

An assembled unit ready for installation using 2-1632 and 1-12SN7 tubes, tone and volume control and six feet of rubber cord **PRICE \$3.95**
(Including Tubes)

PHONO OSCILLATOR

Wireless phono oscillator transmits recording for crystal pick-ups or voice from carbon mike through radio without wires. Can also be used as an intercomm by using P.M. speaker as mike. Price (excluding tubes) .. **\$2.95**

AUTOMATIC RECORD CHANGER KIT

Consists of: A portable simulated leather covered wood cabinet, will take up to 12" records. A single post Detroita record changer. A 5" "Alnico 5" P.M. speaker and output transformer. A complete kit of parts to build a 3 tube phono amplifier (less tubes) **PRICE \$27.95**

JUNIOR PUBLIC ADDRESS SYSTEM

Consists of all the complete parts, cabinets, microphone, speaker and tubes to construct a public address sound system. Contains a 12 page instruction booklet fully illustrated giving simple step-by-step instructions for the construction and operation of this entertaining and useful public address system. Can be adapted for intercommunication. Properly packaged for resale in a beautiful engraved box **PRICE \$14.95**

TELEVISION KIT.

No pains have been spared by the designers of this kit in its layout and elaborate, simplified, step-by-step instructions. The chassis holes suitably made to exactly fit the component parts. Each part is separately packaged with part numbers indicated to correspond with those shown on the construction diagram so as to enable anyone handy with tools to construct a television receiver comparable with the best now on the market. The parts are of the highest type and are unconditionally guaranteed for a 3 month period. This kit is complete in every detail. Absolutely nothing else needed.

Outstanding Features:
3.5 MC bandwidth, giving beautiful picture definition.
25.75 MC trap-tuned, high gain, video I.F. transformers.
Exclusive true F.M. sound circuit.
Three stages of video I.F. amplification.
Two stages of video amplification.
Extremely stable circuits.
Chassis size 17"x15"x4" completely drilled and punched. Modernistic simulated leather covered heavy wood cabinet. All 17 tubes including a Dumont Television Cathode Ray are included **PRICE \$159.50**
(Discounts in quantity)

All Prices are
F. O. B.
New York City

RADIO DEALERS SUPPLY CO.

135 Liberty St., New York, N. Y.

Available, a large stock of radio parts, test equipment, etc., at attractive prices.
Write for free catalogue.

WE SHIP
ANYWHERE
PROMPTLY

V-M Automatic RECORD CHANGER

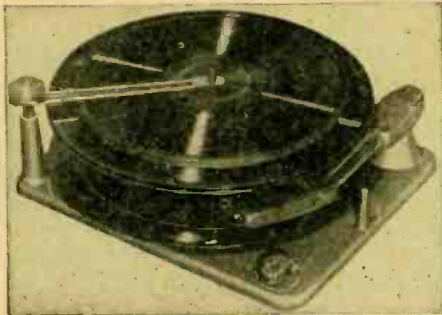

MODEL 400

- Positive Intermix
- Plays all Records
- Service Adjustments Eliminated
- Completely Jam-proof
- Minimizes Record Wear
- Records gently Lowered on Spindle—Not Dropped

Custom-Built Quality at a Competitive Price

The "400" will intermix 10" and 12" records in any sequence—unaffected by variations in diameter, uneven edges or warped surfaces. Records are gently lowered—not dropped—on spindle step, eliminating breakage or chipping. Records cannot jam in the ejecting mechanism. Tonearm may be held and control knob turned to any position during cycle—automatic shut-off. The only adjustments in the machine are for needle height and set down—both made from above the base plate. Mechanism will not slip or vibrate out of adjustment. These and other exclusive features mean simply that the "400" will sell easily—quickly. Distributors, dealers, servicemen—write for details.

RETAIL PRICE
\$47.50

* Slightly higher west of Rockies.

V-M CORPORATION • BENTON HARBOR, MICH.

PRINTED RADIOS (Continued from page 69)

ulating laminations less than a half-inch thick. This, then, is the future chassis of your radio. It can be snapped into position in a few seconds and snapped out again if desired.

In the future when the serviceman finds burned out resistors, or some other trouble that is likely to mean several hours of work, he simply will snap out the laminated-sheet chassis, throw it aside and snap in a new chassis. Such a replacement chassis should not cost the serviceman more than \$1.00, even for a 6-tube superheterodyne.

In a matter of seconds the set will play again. When the chassis is put back into its cabinet, as far as the serviceman is concerned, the job is finished. The old chassis is simply discarded, as it will not pay anyone to spend much repair time on it; it could not be taken apart successfully anyway without special tools. As the new chassis costs very little, the customer practically gets a new set for very little money.

Many books can and will be written on the subject of printed radios. While we have described the new technique only sketchily for the purpose of this article, the reader should understand that we still are at the beginning of this revolutionary radio idea. During the next few years many other improvements will be added to this new art.

Wiring diagrams, power plug connections, and instructions for operation on AC; available for most gov't surplus receivers and transmitters. 50c in coin per set. BC-191; BC-342; each set in SCR-274; TU-5 thru TU-10; BC-312; BC-348; etc. Reactron Company 422 E. 138th St., New York 54, N. Y.

A. C. 110-VOLT MOTORS

Selsyn Syncro Differential—New in Original Package.

A Bargain at \$1.75 while they last

LYELL HARDWARE

P. O. Box 5, Rochester 11, New York

AUDIO OSCILLATOR

(Continued from page 33)

should be at least 0.5 μ f to avoid phase shift at the ends of the spectrum. With a minimum frequency of 12.5 cycles per second, the author chose 1- μ f condensers. They give some distortion below 20 c.p.s., but this is not severe. These are 400-volt paper condensers of the smallest size available. They are taped to a small metal strip suspended halfway between the top and bottom of the chassis. This keeps them as far from the chassis as possible. Leads to the condensers should be as short as possible.

The feedback condenser C4 is a 6- μ f unit mounted above the chassis where leads can be kept short. In this model, R3 is a 1,670-ohm, 1-watt resistor. Its value should be determined by inserting a variable resistor at this point and varying it until there is minimum distortion over the range of the oscillator. When this is done, measure its resistance and replace it with a 1-watt fixed resistor of equal value.

Lamps L1 and L2 are the so-called night-lamp variety, 6 watts at 120 volts.

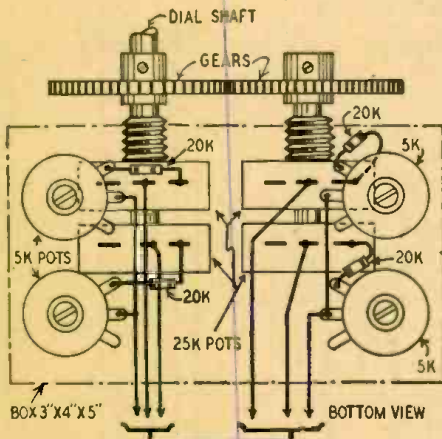

SPREAD AND BRING THRU SEPARATE HOLES IN CHASSIS SLOTTED 5K SHAFTS ADJUST FROM BELOW

Fig. 2—How variable resistors are mounted.

These are G-E 6S6's and are generally available. Sockets for these lamps are rather large. They should be taken apart and the contact parts mounted on a strip of bakelite, insulating the parts where necessary with sealing wax. The sockets are mounted on the rear of the chassis as shown in the rear-view photograph.

The volume control is a standard 1/2-megohm unit with an audio taper. Mount it close to the plate of the 6J5 and grid of the 6SN7, and run an extension shaft through the front panel.

Power supply

The power supply chassis is open at the bottom and one side. It is fastened to the left side of the case with self-tapping screws through lips on the side and bottom. The large filter and decoupling condensers shown in the diagram are not required. They were used because they were on hand. Condensers of 8 μ f in the filter and decoupling cir-

BIG NEWS ... FOR RADIO SERVICEMEN AND DEALERS

Here are the Extra Special Deals on top condition, slightly-used Test Equipment typical of the amazing bargains Walter Ashe is in a position to offer. Let us quote you on the deal of YOUR choice.

DEAL No. 1

Feiler Signal Tracer, regular price	
Jackson 637TT and VOM, regular price	\$ 9.85
Philco 670 Signal Generator, regular price	80.00
Total Value	39.95
OUR SPECIAL PRICE	\$129.80
YOU SAVE	\$64.80
(Subject to prior sale)	

DEAL No. 2

McMurdo Silver Spax, regular price	\$39.90
Superior PB-100 Volt-OHM-Milliammeter	27.50
Monitor Crystaliner, regular price	\$7.50
Simpson 305 Tube Tester	48.50
Total Value	\$173.40
OUR SPECIAL PRICE	\$85.00
YOU SAVE	\$88.40
(Subject to prior sale)	

YOUR FAVORITE BRANDS OF TEST EQUIPMENT

Hickok	Waterman
Jackson	Du Mont
Precision	Feller
Simpson	Meissner
McMurdo Silver	Triplet
Radio City Products	Relver
Robson-Burgess	R.C.A.
Chicago Industrial	Bitley
Special Products Co.	Hanlan
Industrial Equipment	
Cornell-Dublier	Monitor Piezo
Coastwise Electronic	Weston Sprague

Other used Test Equipment Combinations at comparable savings are generally available. Write for details. And if you're interested in trading new for old, our complete stocks and bigger-than-ever trade-in allowances on your used equipment are sure to please expert and apprentice alike.

WQJWB WQWTM WQPGI
WQULH WQNRH WQQDF WQIYD

HI POWER FOTO FLASH KIT

THOROUGHLY PROVED AND TESTED

1. Uses AMGLOW 54R4X 200 watt second flash tube.
2. Uses parallel bank condensers. 25% safety factor. No costly replacements.
3. Synchronizer adjustment control.
4. Light weight, Heavy Duty, Army Surplus, High Voltage transformer.
5. Unit can be fired every 3 seconds if necessary.
6. Neon bulb charge indicator.
7. 1/10,000 second exposure.
8. Triggered by hand switch or synchronizer.
9. Sockets for connecting all cables.

Complete Kit including AMGLOW tube, carrying case, etc., with simple assembly and operating instructions. **\$77.50**

Price subject to change without notice. Write for detailed description and parts list.

Remember... your Trade-In's worth more at the Walter Ashe Store! For bigger-than-ever allowances on your used Test Equipment wire, write or phone us today!

Coming! A new, bigger, better Walter Ashe catalog. Ask to have your name placed on our mailing list.

Walter Ashe RADIO CO.

1125 PINE ST. • ST. LOUIS, MO.

Do you need BINDING POSTS?

The XL PUSH POST with its Spring Action assures Constant Contact and quick connection. Manufactured in All Aluminum Type M at 12c each. Aluminum Body, Bakelite Top Type B1 at 15c each. Types CP or NP, ALL BRASS-STAINLESS STEEL SPRING & PIN. PROVEN by 240 HR. SALT SPRAY TEST as NON-CORROSIVE at 28c each. Manufacturers and Dealers Liberal Discounts

X. L. RADIO LABORATORIES
420 West Chicago Ave., Chicago 10, Ill.

VIDEO

Amazing Television Handbook. How to construct, install, operate, service, sight and sound receivers. How video is growing. How a transmitting station works. How receiver works. How to build receiver. How to erect antenna. How to install. Trouble shooting. Video dictionary. Three separate 15" x 16" assembly stage diagrams. Written by a master, in simple language. 96 pages, 71 illustrations, heavy glossy paper, spiral binding lies flat. Only \$1. Your money back in 10 days if not delighted. HURRY. Write Norman W. Henley Publishing Co., Dept. R.C., 17 West 45th St., New York 19, N. Y. (Send for Catalog of Technical Books)

cuits should be ample. Choke input filter affords better regulation and should be used unless the output voltage is too low. Then condenser input may be used.

Adjustments and calibration

One nice feature of this oscillator is that the tuning dial can be prepared in

(Continued on page 72)

NOW! *in* 1,000 pages



Handsomely bound in RED and GOLD

All data and basic knowledge in radio and electronics digested into 12 sections... in a complete, quick to find, easy to read, handbook form.

Plan every operation in radio and electronics with the *Radio Data Book*. This new radio bible will be your lifelong tool... you will use it every day, on the board, at the bench, in the field! Use it for construction, troubleshooting and testing. The *RADIO DATA BOOK* will be your invaluable aid in design, experiment and in layout. It will help make your production better, faster and easier. In any and every operation in radio and electronics, you will use the *RADIO DATA BOOK*!

The *RADIO DATA BOOK* is a work of complete authority, prepared by engineers with many years of practical experience. They have been assisted by the Boland & Boyce staff of editors skilled in preparing electronics manuals for the U. S. Signal Corps for many years. These men have worked for several years gathering material for this book... all the knowledge of radio principles and operation... all the statistics... all the newest developments in electronics... every possible angle and detail. Eighteen months were spent digesting this material into the most concise, the clearest, and the most readable form. The result is this invaluable manual... The *RADIO DATA BOOK*. Whether you use this book for general reference, for scientific instruction, or for education, one thing is certain—the practical help, the daily usefulness you will derive from it will prove to be worth many, many times its astonishingly low price!

Advanced Sale... first printing, Only 10,000 available... To make sure to get your *RADIO DATA BOOK*, mail your order **NOW!**

- 12 sections... 1000 pages... Completely Illustrated
- Section 1. THE 150 BASIC CIRCUITS IN RADIO.
 - Section 2. COMPLETE TEST EQUIPMENT DATA.
 - Section 3. TESTING, MEASURING AND ALIGNMENT.
 - Section 4. ALL ABOUT ANTENNAS.
 - Section 5. SOUND SYSTEMS.
 - Section 6. ELECTRICAL AND PHYSICAL CHARACTERISTICS OF RADIO COMPONENTS.
 - Section 7. COMPLETE TUBE MANUAL.
 - Section 8. CHARTS, GRAPHS AND CURVES.
 - Section 9. CODES, SYMBOLS AND STANDARDS.
 - Section 10. 50 TESTED CIRCUITS DESIGNED FOR OPTIMUM PERFORMANCE.
 - Section 11. DICTIONARY OF RADIO AND ELECTRONIC TERMS.
 - Section 12. RADIO BOOK BIBLIOGRAPHY.

12 complete books in one only **\$5.00!**
Less than 42c per book!

MAIL THIS COUPON TODAY!

BOLAND & BOYCE INC., PUBLISHERS
460 BLOOMFIELD AVE. MONTCLAIR 5, N. J.

Please send me a copy of THE RADIO DATA BOOK Enclosed is \$5.00

NAME _____
ADDRESS _____
CITY _____ ZONE _____
STATE _____

BOLAND & BOYCE INC., PUBLISHERS

AUDIO OSCILLATOR (Continued from page 71)

advance. Because of the small tuning ratio (2 to 1) the precalibration deviates very little, if any, from actual calibration.

Graph paper is used as in Fig. 3. Calculate a number of points from the formula:

$$100$$

percentage of R in circuit, using enough points to give a smooth curve. The Y-axis of the graph is calibrated in linear steps from 1 to 2, representing dial markings. (The two dashed lines are an example showing that for 80% of the resistance in circuit, the multiplier, or number by which the base frequency of the range is multiplied to get the actual frequency, is 1.25.)

Next cut a strip of paper C-D the exact length of the dial scale. The length may be found from the formula:

$$C/360 \times 2\pi r = \text{length};$$

where C is the angle of resistor rotation, and r is the scale radius. For example, if the useful rotation of the

potentiometer is 280 degrees and the scale radius is 2.5 inches, its length is 12.2 inches.

$$(280/360 \times 2 \times 3.14 \times 2.5).$$

Small triangular tabs are left on the strip, as shown in the figure.

The strip is laid across the graph at an angle so that its ends rest on the limits of the x-axis. Dial markings are projected on the strip as shown. Now fold the tabs inward at right angles and bend the strip along the arc of the scale to be drawn, making sure that the ends of the strip correspond exactly with the ends of the scale. Hold the strip and scale together with thumb tacks or tape on a drawing board as shown in Fig. 4. The markings from the strip are carefully transferred to the scale where they are inked, and numerals are added. (The final dial may be a positive photostat. See "New Ideas in a Vacuum-Tube Voltmeter," *RADIO-CRAFT*, April, 1947, for suggestions for making dials and markings for instruments.)

(Continued on page 74)

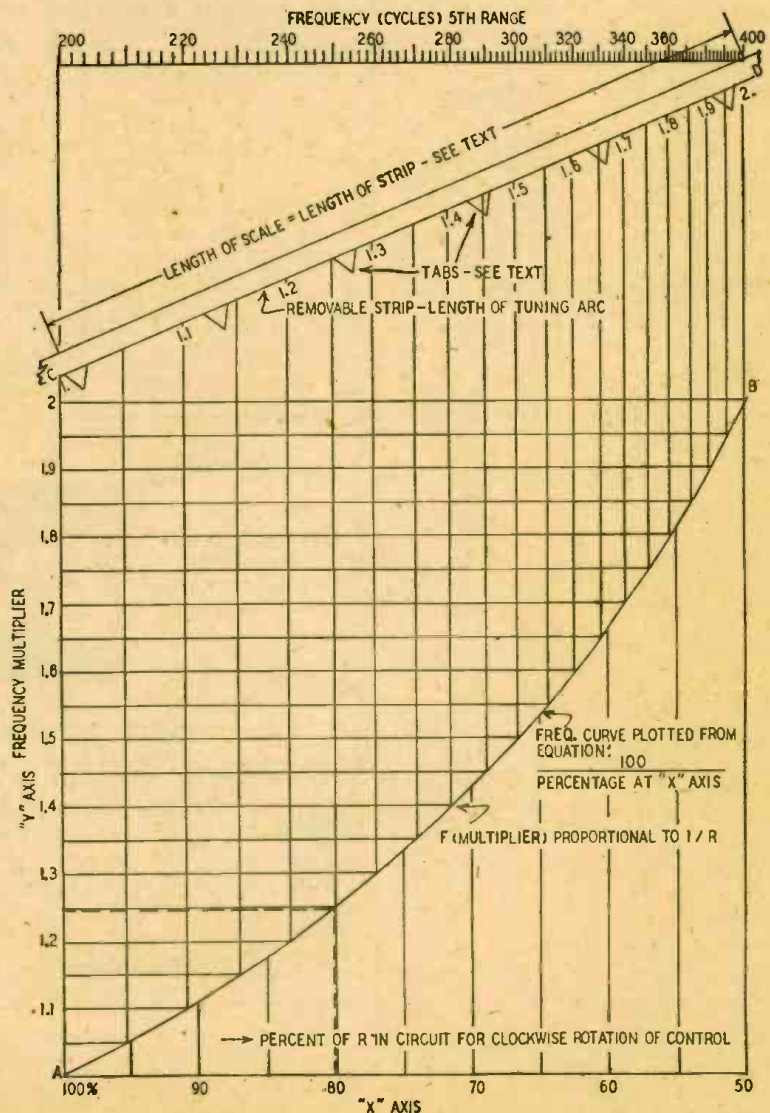

Fig. 3—The chart used to prepare the precalibrated dial. Dial strip is across top.

SENCO DECLARES A BUYER'S DIVIDEND

721A-RELAY TUBE

used in transceivers with a single antenna to prevent damage to receiving coils. Also can be used for two different levels of RF

only **19c** each

SPEAKER SALE

Limited Quantity—so Hurry.

4" P.M. Speaker	\$1.19
5" P.M. Speaker	1.15
6" P.M. Speaker	1.55
8" P.M. Speaker	ea. 2.75
Lot of 12	30.00
12" P.M. Speaker	
Alnico 5 magnet	ea. 5.95
Lots of 12	66.00

40 x 40 Electrolytic Cond. 150 V.	\$.49
50 x 30 Electrolytic Cond. 150 V.49
30 x 20 at 150 V. and 20 mfd at 25 Volts45

120 Mil Power Transformer	
Primary 110 V, Secondary 6.3	
Rectifier 5 V. H.V. 600 V C.T.	\$3.25

225 Mil Power Transformer	
Primary 110 V, Secondary 6.3	
Rectifier 5 V. H.V. 600 V C.T.	\$4.25

VM MIXER CHANGER

Model 200B, 2 Post.

Sensational! Plays 10" and 12" records intermixed with no adjustment. Light, crystal pickup. One control knob for on, off, manual, automatic, press to reject. 110 Volt, 60 cycle, noiseless motor. 15 x 14 x 7 1/2" H. Wgt. 16 lbs. Only **\$15.95**

LEADING BRAND AC PHONO MOTOR

60 cycles, 115 volts with Turntable with Standard Make Crystal Pickup.



Complete **\$435**

100,000 RADIO TUBES

Every tube guaranteed. Every tube in carton.

Type	Each	Each	Type	Each	Each
0Z4	59c	50c	7Y4	44	35
1H5GT	59	45	7X7	44	35
1U5	36	30	7AF7	44	35
1N5GT	59	45	14X7	44	35
1V	45	39	12A8GT	54	45
1L4	55	49	12C8	80	70
1T4	55	49	12J5GT	49	39
5U4G	55	40	12J7GT	45	39
5W4GT	40	36	12K7GT	45	39
5Y3GT	40	37	12K8	65	59
5Y4G	40	37	12Q7GT	45	39
5Z3	40	37	12SA7GT	40	32
6A7	55	45	12SQ7GT	40	32
6A8GT	59	44	12SK7GT	45	35
6AC7	65	60	12SJ7GT	55	50
6BA6	50	45	24A	49	37
6B7	55	49	26	39	30
6C5	50	45	41	45	40
6C6	45	37	42	47	42
6C8G	45	37	45	49	39
6D6	45	37	47	49	41
6F6GT	45	40	56	49	39
6H6GT	45	40	57	45	39
6J5GT	55	50	58	45	39
6K7GT	49	40	71A	39	29
6L7	69	59	75	50	40
6N7	95	83	76	45	39
6Q7GT	47	42	77	40	32
6U7G	40	35	80	40	38
6V6GT	59	49	84/6Z4	45	36
6X5GT	49	40	25L6GT	60	50
6SA7GT	44	37	25Z5	59	47
6SJ7GT	44	37	25Z6GT	55	43
6SK7GT	44	37	35L6GT	60	50
6SL7GT	55	47	35W4	45	40
6SN7GT	55	47	35Z3	44	35
6SQ7GT	47	42	35Z5GT	49	39
6SG7	44	39	50L6GT	55	45
6ZY5G	45	40	117Z3	55	45
7A4	44	35	12AT6	55	45
7A7	44	35	12BA6	55	45
7B6	44	35	12BE6	55	45
7B7	44	35	50B5	42	32
7C6	44	35	32L7GT	60	50

ADJUSTABLE PANEL LAMP ASSEMBLY
Mounts in 1/2-inch hole on panels to 3/4 inch. The red jewel assembly is with shutter that controls the visible glow. 15c ea.

Oak Record Changer, 2 Post. 17.95

1629 Tuning Indicator— 829 Push Pull twin-unit.
Tri. (Music Eye) tube Beam power amplifier
19c ea. tube \$1.49 ea.

Mallory—6 Volt 4 Prong Auto Vibrator \$1.19 ea.
2 Volt Vibrator 99c ea.

Standard—20 MFD—20
volt PP Plug in type
condenser 10c 8 FT-AC Line cord 29c

BRAND NEW WILLARD *20-2 2 VOLT STORAGE BATTERY

Used in General Electric model #530 charge A PACK Portables. Suitable for all Farm Radio sets. Individually boxed. List Price \$8.95. Special **\$2.49** each



Kit of 100 assorted insulated resistors popular ohmmakes. 1/3, 1/2 & 1 watt \$1.79

Western Electric Thermistor No. D-163903 50c ea. Buss H.C.M. fuse holder 10c ea.

456 K.C. IF Coils. Input & Output. medium size 49c ea. 500 M ohm V.C. with Switch 2 1/2" Shaft. Popular Brand 40c ea.

P.P. Input transformers 79c ea.

Signal Corps

Dual Headsets

Your choice, 2000 ohms or 8000 ohms. Individually boxed. Brand new.

List Price \$12.50

\$1.59 each



General Instrument

De-Luxe Record Changer With Automatic Stop

Plays ten 12-inch or twelve 10-inch records at one loading, and stops automatically after last record is played. \$18.95

25% deposit on all orders, balance C.O.D., F.O.B. New York

SENCO RADIO, Inc.

96 WARREN ST., N. Y. 7, N. Y.
TEL. CORTLANDT 7.6065

250-Watt FM-AM Transmitter (Continued from page 30)

side of the center frequency. This amount of deviation will give the best audio output when received on the i.f. slope of a standard communications receiver; for reception of a widely deviated signal it will be necessary to use an FM receiver which incorporates a discriminator-type detector for converting the frequency variations into an audio signal voltage. Methods of converting a communications receiver to narrow-band FM were described in the July RADIO-CRAFT.

The deviation control should be calibrated directly in terms of frequency deviation. The points which correspond to deviations of 1, 2, 3, 4, 5, 7, and 10 kc should be marked. A zero-center d.c. voltmeter, of 20,000 ohms per volt or higher, may be permanently connected to the deviation meter jack and its voltage scale, each side of center, calibrated in terms of frequency deviation. Such an instrument will give a valuable visual indication of the band width of the transmitted FM signal.

As FM is comparatively new on the amateur bands, the author would like to hear from hams who build this transmitter or who are interested in FM transmitting schedules and tests on 10 meters. Any questions with regard to the operation of the transmitter will be cheerfully answered. Address the author in care of this magazine.

LAKE DELUXE CHANGER



Revolutionizes the Industry!
A SENSATIONAL SELLER!

11 OUTSTANDING FEATURES:

- Positive Intermix
- Service Adjustments Eliminated
- Minimizes Record Wear
- Single Knob Control
- Plays ALL Records
- Completely Jam-proof
- Records Gently Lowered on Spindle—not dropped
- Automatic Shut-off on last record

- Pick-up arm may be grasped at any time and changer will not be thrown out of adjustment
- Resonance-free ball bearing tone arm
- Easily operated—any child can do it

Dimensions: 13 13/16" W x 12 1/4" D x 7 7/8" H No. 116A4 **\$2873**

SERVICEMEN—RETAILERS
Join our customer list today.
Write today for our new 16-page illustrated catalog NR-116. It's free. Get on our mailing list.
Dept. C

LAKE RADIO SALES CO.

615 W. Randolph Street, Chicago 6, Ill.

Television prices will drop sharply, possibly within the year, Dorman D. Israel of Emerson Radio and Phonograph Corp. stated last month, according to the N. Y. *Herald-Tribune*. Price breaks might be due to improved production techniques and expanding mass markets.

LEARN

ELECTRICITY OR RADIO

... in the
GREAT SHOPS OF COYNE
Train in a Few Short Weeks

Here at Coyne in a few short weeks you can train for your big opportunity in Electricity or Radio. You train on actual full-size Electrical or Radio equipment. 48 years training experience. For Veterans and non-veterans.

NOT A "HOME-STUDY" COURSE

All Coyne training is given here in our big Chicago shops. Not a Correspondence course. VETERANS Coyne is authorized to train Veterans under the G.I. Bill. Coupon brings details.

FREE BOOK Two great opportunity fields—rush coupon for free illustrated book on whichever course you prefer—no obligation. Tells how Coyne helps you get better jobs.

Your Choice of 2 Great Fields
B. W. COOKE, Dir.,
COYNE ELECTRICAL
SCHOOL, Dept. 67-78M
500 S. Paulina St., Chicago 12, Ill.

Send FREE BOOK and full details on course checked:

ELECTRICITY RADIO
NAME.....
ADDRESS.....
CITY..... STATE.....

Translations of United Nations speeches are now made simultaneously into 5 languages and broadcast over a short-range radio system. Delegates and others who listen to the translations wear one-pound battery receivers tuned to get the speech in the desired language.

IT'S NEWARK for TOP QUALITY - BEST VALUE

Sensational Buy!

HALLICRAFTERS PANORAMIC ADAPTOR SP-44



Really Terrific! The famous Sky Rider, sold everywhere for \$99.50, now reduced at Newark to only \$49.50. "Seeing Eye of Sending" is a 10 Tube Superhet, electronically-tuned, with self-contained scope-monitors up to 200 kc visually and analyzes signal characteristics from your own or other transmitters. Hooks into any rig. No Ham should be without one.

SP-44—Complete with tubes, for 115 VAC. Shpg. Wgt. 20 lbs. NOW... **\$49.50**

While They Last!

NEWARK CRYSTALS



6-11-20-40-80 Meters Terrific Values! What's left of our famous, accurately calibrated 88c Crystals at this unbelievable price!

Orders filled to within 25 KC of desired frequency in the following groups only. Hurry! **49¢ EA.** \$ for \$1.25
 A—3800-3956 D—8701-8890
 B—6250-6995 E—9000-9250
 C—7200-7265 F—14065-14220

SCR-522 TRANSCEIVER



Terrific Value! Famous Surplus Receiver-Transmitter. Less Power Supply and Control Box. Some have Crystals and Tubes, some may be missing. But the basic unit is ready to operate. Can be converted to 110 VAC. Schematic incl. Shpg. Wgt. 75 lbs. Limited Quantity. "AS IS" for... **\$149.50**
 FOB New York Only

New Types - Bigger Values

Transmitting and Special Purpose TUBES

ALL NEW - GUARANTEED, Great Savings from our Tremendous Stock of Top Grade Gov't. Surplus Tubes. All JAN Approved. Buy Now!

E1148	\$ 2.25	811	\$1.95
HY65	3.00	813	6.75
HY69	1.65	814	4.50
HY615	1.13	815	2.25
TZ40	1.88	826	1.50
2AP1	2.25	832A/832	2.25
2B1A	5.25	836	1.13
2C26A	.75	837	2.25
2C40	.90	838	3.75
2C44	1.50	841	1.20
2V3G	1.38	843	.75
2X2/879	.90	845W	3.75
3AP1	3.00	865	1.50
3BP1	3.00	872A/872	2.25
3C24/24G	.75	874	1.95
3CP1	3.00	884	.75
3EP1	3.00	922	.68
3E29	3.00	923	.45
3FP7	3.00	931A	1.88
3GP1	3.00	954	.75
5AP1	4.50	955	.75
5BP1	3.38	956	.75
5BP4	3.38	957	.75
5CP1	3.38	958A	.75
5CP1A	6.00	959	.75
5LP1	9.00	1613	.75
6KA5	.90	1618	3.00
6D4	.45	1619	.75
7BP7	5.25	1624	.90
91P1	2.25	1625	.53
10Y	.75	1626	.60
12DP7	6.00	1629	.27
12GP7	11.25	1641	.90
OC3/VR105	.75	1665/2050	.90
OD3/VR150	.75	1851	.95
211	1.13	2051	.53
304TL	3.75	7193	.45
316A	.75	8005	3.15
559	1.13	9001	1.05
801A/801	1.13	9002	.90
803	9.00	9003	1.05
807	.95	9004	.90
809	1.50	9006	.68

MALLORY VIBRAPACK



Vibrator Power Supply. Efficient, Dependable. 12 volt DC Input. Output: 220-250 volts at 60 ma. Exceptional Buyl Size: 5 1/2 x 2 1/4 x 6" H. No. S-460. Special... **\$6.95**

ARMY NAVY PHONES Great Buy



Brand New, Guaranteed Army-Navy Phones. 8000 ohms. Rubber covered throughout. Ear Cushions, Cord, PL-54 Plug. Adj. band. No. S-481. Hurry!... **99¢**

Cornell-Dubilier Xmitting Capacitor

2 Mfd—1,000VDC New, oil-filled, Exceptional Quality 4 1/2" L. x 1 1/2" dia. No. S-473. **49¢** Special.

AUDIO OSCILLATOR
(Continued from page 72)

There are 2 threaded, metal pillars on the front of the resistor tuning unit. They can be seen at each side of the main gear in the under-chassis photo. These enable the constructor to make calibration checks with an auxiliary dial (a photostatic copy) cemented to a metal plate screwed to the pillars. The instrument can be adjusted and checked before it is placed in the case. The power supply and oscillator chassis should be placed on a metal plate to avoid stray pickup and to duplicate conditions found when the instrument is in the case.

With the auxiliary dial in place, check the tuning resistors to be sure that they match and track perfectly for series, single, and parallel combinations. The set of condensers covering from 12.5 to 100 cycles is checked first. After approximating the values as explained, add or subtract small values until the unit tunes properly to the desired frequencies.

Frequency checks can be made only with a cathode-ray oscilloscope using the 60-cycle line frequency as a standard. Connect the oscillator to the vertical plates and a 60-cycle signal to the

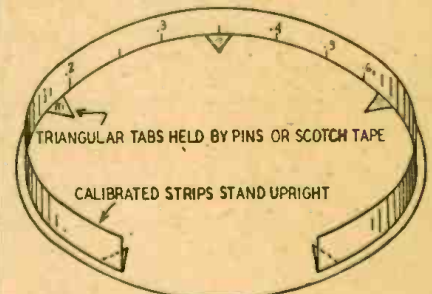

Fig. 4—How dial calibrations are transferred.

horizontal plates of the scope and set the multiplier at 1.2. Lissajous patterns, as

TABLE II

Base Frequency	Vertical Loops	Horizontal Loops	Actual Frequency (c.p.s.)
12.5	4	1	15
25.0	2	1	30
50	1	1	60
100	1	2	120
200	1	4	240

described in Table II, will be obtained for the base frequencies listed.

The pattern for the first range will have 4 loops, one above the other; the second resembles a figure 8; and the third is a motionless circle. The fourth pattern will be 2 loops along the horizontal axis, and the fifth pattern will have 4 loops side-by-side. Table III indicates the pattern and actual frequency for the first 5 ranges and for multiplier settings of 1.0, 1.2, 1.44, 1.5, 1.6, 1.8, 1.92, and 2.0.

The 60-cycle line frequency is useless as a standard for calibrating above the fifth range. A 360-cycle oscillator should be constructed for use as a standard.

ORDER FROM New York or Chicago. Shipment, FOB N.Y. or Chicago. 70% Deposit Required with C.O.D. Orders. Send Full Amount of Order—Save C.O.D. Chgs. Prices Subj. to Change.

BUY OVER \$75 WORTH OF EQUIPMENT Take ONE YEAR to PAY 20% Down—Pay Monthly

NEW YORK CHICAGO
 Offices & Warehouse 323 W. Madison St. Chicago 6, Ill.
 242 W. 55th St., N.Y. 19
NEWARK ELECTRIC COMPANY, INC.

New York City Stores: 115-17 W. 45th St. & 212 Fulton St.

MONEY TALKS!

DOUGLAS OFFERS The Lowest of Low Prices on the Map!

METERS AT SPECIAL PRICES

Marion 3" 0-1 ma. 0-100 ma. 0-200 ua. 0-500 ua. Your special price \$3.75
 Marion 2" 0-2 ma. 0-5 ma. Your special price \$2.85
 DOUGLAS Decibel Recording Meter, for magnetic or crystal recording. Your special price \$4.98

DOUGLAS

5 Tube A.C. D.C. Super-het Kit, Model 500 with tone control. Complete with chassis, cabinet and all parts, less tubes. Your special price \$13.93

CHASSIS AND CABINETS

5x9 1/2 x 1 1/2 20 gauge steel black finish. Special 53c
 Amplifier Chassis 5 1/2 x 10 1/4 x 9 with top. Special \$2.06

Metal Cabinet 10x8x10. Special \$2.40
 New Penell Soldering Iron with interchangeable tips. Your special price \$1.20 with 1 tip
 Midret I.F. coils, iron core tuning. Special 77c ea.
 AMPLIFIER KIT, A.C. D.C., 3 watt output, complete with tubes, parts, chassis. Special \$10.43
 PHONOGRAPH KIT, complete with all parts, motor, turntable, pickup and cabinet for use with above amp. Special \$10.95
 Speaker Kit includes 5" Alnico speaker and cabinet. Special \$4.58
 MICROPHONE KIT, complete with stand and cable for use with amp. Special 5.98
 SPECIAL 12" G.E. 0.8 oz. Alnico magnet Speaker. Your price \$7.45
 RESISTOR KIT, 100 asst. 1/4, 1/2, 1, 2 watt sizes. Your price \$1.95

TUBES—COMPLETE LINE OF ALL HARD TO GET TUBES. SEND US YOUR ORDER AND WE WILL SURPRISE YOU WITH PROMPT DELIVERY AT DISCOUNT PRICES

If it's hard to get—we have it!!

25% Dep. on C.O.D. Send for Free Catalog BA-7-3956
DOUGLAS RADIO SUPPLY CO.
 128 GREENWICH STREET NEW YORK, N. Y.

Build Your Own FM TUNER

FM—VARIABLE CONDENSER (88 to 108 Mc) and complete set of **\$4.95**
 MATCHED COILS with SCHEMATIC CHART and INSTRUCTIONS
 for building your own FM TUNER

RADIO TUBES - KNOWN BRANDS - BULK

	EACH
24, 26, 27, 45, 75, 77, 78	\$.39
80, 5U4, 5Y3, 5Y4, 35W4, 35Z5	.42
6A7, 6C6, 6D6, 6F5, 6J5, 6J7	.42
6A8, 6H6, 6K7, 6Q7, 6SA7, 6SK7, 6SQ7	.44
12BA6, 12SK7, 25Z5, 25Z6, 35Z3	.44
12Z3, 12BE6, 12SN7, 12SQ7, 12SR7	.47
35L6, 50B5, 50L6, 12AT6, 12SA7	.49
42, 43, 1A7, 1H5, 1N5, 6L6, 6V6, 6X5	.59
0Z4, 7A8, 7B4, 7B5, 7B7, 25L6, 50A5	.65
1R5, 1S4, 1S5, 1T5, 3S4, 3Q5, 1LN5	.74
1LA6, 1LE3, 70L7, 117L7, 117Z6, 25A6	1.10

PAPER TUBULARS

.001 - 600 V.	
.002 - 600 V.	
.005 - 600 V.	
.01 - 600 V.	
.02 - 600 V.	
.05 - 600 V.	
.1 - 600 V. (Per Hundred)	6.40
.25 - 600 V. (Per Hundred)	9.75
.5 - 600 V. (Per Hundred)	14.50

\$3.95
 PER HUNDRED

ELECTROLYTICS

8 - 150 V. (Each)	.15
20 - 150 V.	.20
30 - 150 V.	.25
20/20 - 150 V.	.26
40/40/20 - 150 V. - 25V.	.44
8 - 450 V.	.27
16/16 - 450 V.	.59
10 - 450 V.	.32
16 - 450 V.	.36
20 - 450 V.	.39
40 - 450 V.	.54

DESIRABLE PARTS - The Prices Speak for Themselves

Elec. Phono. Motor, w/9" Turntable	\$2.95
CRYSTAL PICK-UP ARM	1.75
4" PM SPEAKER, Alnico #5 Magnet	.95
5" PM SPEAKER, Alnico #5 Magnet	1.22
5" DYN. SPEAKER, 450 ohms, with Output Trans.	1.95
VOLUME CONTROLS, 1/2 or 1 Meg with switches	.39
OUTPUT TRANSFORMER, match 50L6	.39
LINE CORDS, approved, 6 ft., 18 gauge	.14
TOGGLE SWITCHES, SPST	.15
TOGGLE SWITCHES, DPST	.25
TOGGLE SWITCHES, DPDT	.40
AUTO VIBRATOR, standard over 700 Auto Radios	1.45
SOLDER (Rosin) per pound	.55
DETROLA RECORD CHANGERS	13.50
INTERCOMMUNICATION SYSTEM, list \$34.95	17.97
PHONO AMPLIFIER, includes 3 tubes	3.70
RESISTANCE CORDS, 160 to 290 ohms	.39
SOLDERING IRON, 100 Watts	1.90
OSCILLATOR COIL, 456KC	.19
I.F. COIL, 456KC	.49
VARIABLE CONDENSER, 2-Gang, 420/162	.68
TELEVISION ANTENNA, list \$14.50	7.25
TELEVISION LEAD-IN, 300 ohm (per 1000 ft.)	19.80
COAXIAL CABLE # RG 59U, 72 ohms per 1000 ft.	64.20
ELECTRIC PORTABLE PHONO. (3 Tube)	12.95
SELENIUM RECTIFIER	.95
RESISTORS, 1/2 Watt (100 assorted)	1.50
KNOB (100 assorted)	4.50
SOCKETS (100 assorted)	5.00
PILOT LIGHTS (100 assorted)	4.50
BROOKS INVERTER, 50 Watts-110V.	8.95
LOOP ANTENNAS, asst. sizes, oval	.29

BROOKS RADIO DISTRIBUTING CORP.

80 VESEY ST. DEPT. A NEW YORK 7, N. Y.

This auxiliary oscillator may be tuned with variable resistors or trimmer condensers to its 360-cycle fixed frequency. It may be calibrated by comparing the 60-cycle standard in the 'scope. Connect the 360-cycle oscillator to the horizontal plates of the oscilloscope, and the audio oscillator to the vertical plates. With the base frequency switch set at any of the higher ranges, turn the multiplier till an easily read pattern appears on the 'scope. Divide the number of horizontal loops by the number of vertical ones, and multiply the quotient by 360. The product is the frequency at which the audio oscillator is working.

As a check on the dial accuracy, divide the actual frequency by the base frequency. The quotient should be the number indicated by the pointer.

After calibration, the wave forms should be checked on the 'scope. With this model, maximum undistorted output is 1 volt and 20 volts from the low- and high-impedance outputs, respectively. Maximum outputs are 1.5 and 35 to 40 volts.

If a direct reading dial is desired, several scales may be drawn on the dial, each being calibrated directly in cycles.

An osciMator such as this one can be built into a 'scope to replace the conventional saw-tooth circuit. This can provide convenient precision frequencies of 300, 1,200, and 4,800 cycles that can be selected with a double-pole, 3-position switch. The tuning elements would consist of combinations of resistance and capacitance to tune to the desired frequencies.

TABLE III

No. of Loops	Base Freq. 12.5		Base Freq. 25		Base Freq. 50		Base Freq. 100		Base Freq. 200	
	Horiz.	Vert.	Freq.	Mult'r	Freq.	Mult'r	Freq.	Mult'r	Freq.	Mult'r
1	1				30	1.2	60	1.2		
1	2									
1	3	20	1.6							
1	4	15	1.2							
2	1						120	1.2		
2	3			40	1.6					
2	5	24	1.92							
3	1						180	1.8		
3	2					90	1.8			
3	4			45	1.8					
3	5			36	1.44					
4	1								240	1.2
4	3					80	1.6			
4	5			48	1.92					
5	1								300	1.5
5	2							150	1.5	
5	3					100	2.0	100	1.0	
5	4					75	1.5			
5	6					50	1.0			
6	1								360	1.0

BA BARGAIN SPECIALS



The FINEST in HEADPHONES

Type P23. The Choice of the Air Corps headphones, highly sensitive, 8000 ohm impedance, bipolar magnets. Extremely comfortable sponge rubber ear cushions - stainless steel leather covered headband - concealed terminals - Six Foot Card with PL55 plug; EVERY ONE BRAND NEW in Original Factory Cartons.

Stock No. 5A134 \$13.50. Value **\$2.95**
 An Outstanding Buy, only.....

12 1/2 Ft. ANTENNA TELESCOPES DOWN to 1 Foot 4"

"Just it" for mobile equipment, portable receivers and transmitters. Ruggedly constructed - smooth telescopic action from 12 inches to 12 1/2 feet. Base is 3/8" in dia. with 3/4" threaded shank. By adding eyelets it makes an ideal compact fish pole. An Outstanding Value **\$1.95**
 No. 38A39, Only.....

ORDER NOW, from this ad Add Postage

BURSTEIN-APPLEBEE
 1012-14 MCGEE STREET, KANSAS CITY 6, MISSOURI

ROTA-BASE

NEW HANDY LAB. DIAL actually gives a "prong" picture of radio tube connections. Simply turn the dial to the tube number desired on the ROTA-BASE and complete correct connections are instantly indicated on the "prong" diagram. No more valuable time lost thumbing pages or on lengthy readings. Filament, grid, plate, cathode, etc., to MORE THAN 300 tube types are given. PRICE NOW ONLY \$1.00 postpaid or sent C.O.D. plus postage. Order NOW, money refunded if you are not delightfully pleased. 411 S. Main St. REED MFG. CO. - Los Angeles 13, Calif.

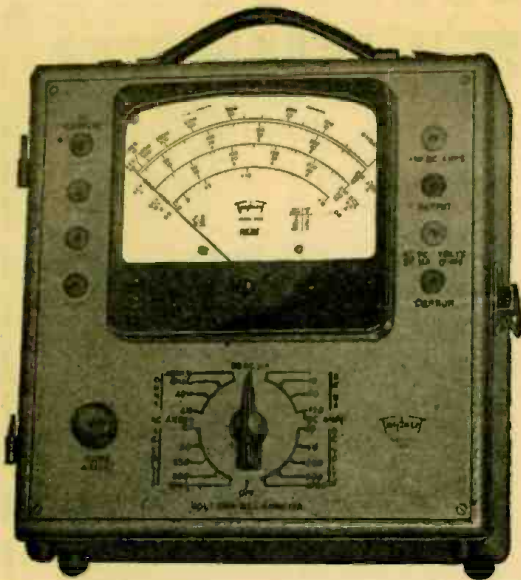

MODEL 2405 Volt-Ohm-Milliammeter

25,000 OHMS PER VOLT D.C.



SPECIFICATIONS

NEW "SQUARE LINE" metal case, attractive tan "hammered" baked-on enamel, brown trim.

■ **PLUG-IN RECTIFIER**—replacement in case of overloading is as simple as changing radio tube.

■ **READABILITY**—the most readable of all Volt-Ohm-Milliammeter scales—5.6 inches long at top arc.

■ **RED-DOT LIFETIME GUARANTEE** on 6" instrument protects against defects in workmanship and material.

NEW ENGINEERING • NEW DESIGN • NEW RANGES 30 RANGES

Voltage: 5 D.C. 0-10-50-250-500-1000 at 25000 ohms per volt.

5 A.C. 0-10-50-250-500-1000 at 1000 ohms per volt.

Current: 4 A.C. 0-.5-1-5-10 amp.

6 D.C. 0-50 microamperes—0-1-10-50-250 milliamperes—0-10 amperes.

4 Resistance 0-4000-40,000 ohms—4-40 megohms.

6 Decibel -10 to +15, +29, +43, +49, +55

Output Condenser in series with A.C. volt ranges.

Model 2400 is similar but has D.C. volts Ranges at 5000 ohms per volt.

Write for complete description

Triplet

ELECTRICAL INSTRUMENT CO.

BLUFFTON, OHIO.

BONAFIDE VALUES



SHURE T17B
Push Button
Carbon Mike
98¢
With Cord
and Plug
Value \$12.00

SHURE CRYSTAL MIKE
\$6.95
With Stand,
Base and
7 Ft.
Cable
Value
\$18.50



Detrola Record Changer	\$14.69
Webster 56 with Automatic Stop	25.95
Seeburg 2 Post Changer	23.97
Maguire 2 Pos. Changer on Base	
Automatic Stop	14.95
A. C. Motor & Astatic L-70 Pickup	4.75
5" FM Alnico Speaker	1.39
#3" Heavy Slug Speaker—Nylon Cone	1.98
#2" Heavy Slug Speaker or Mike Comb	1.49
1/2 Meg. Vol. Cont. & Sw.—Lots of 6	.49
Federal Selenium Rect.—100 Mill—Lots of 6	.69
100 IRC Resistors Assorted Sizes & Watts	1.79

BONAFIDE RADIO CO.

89 1/2 Cortlandt St., Dept. C, N. Y. 7, N. Y.

BEHIND YOUR CONSCIOUS MIND

? Do you use just your thinking mind? If you do, you are missing 90 per cent of your possibilities. Those occasional hunches are the urges of a vast sleeping force in your inner mind. Learn to develop and direct it. Push obstacles aside and master life with an energy you have overlooked. Send for FREE SEALED BOOK. It tells how to obtain these teachings. Address: Scribe J.Z.B.

? **The ROSICRUCIANS** ?
? SAN JOSE [AMORC] CALIFORNIA ?

TECHNOTES

... ZENITH PORTABLES

Several portables, including the Model 6G001Y, are subject to intermittent drops in volume. This trouble often can be traced to the second i.f. transformer. There is a 47,000-ohm load resistor in this can. Replace this transformer with a Zenith transformer No. 95-805.

WILBUR J. HANTZ,
Cleveland, Ohio

... RCA MODEL 54B1

Several RCA Model 54B1's have come in with the complaint that the set stops playing soon after it is turned on. Symptoms pointed to the oscillator stage. Replacing the 1R5 did not cure the trouble. A check showed that the oscillator screen grid condenser (No. 70453, 0.02-100 volts) was leaky. Replacing this condenser cleared up the trouble.

PETER CASELLA,
New Orleans, La.

... FILING TECHNOTES

When I find a Technote relating to a particular make and model of set, I cut it out and glue it in my service manual on the page corresponding to the same make and model. This sometimes saves me a great deal of time.

JACK SAMUELS,
Olympia, Wash.

... PHILCO 46-1201

I have found several Philco 46-1201's which play intermittently or stop as soon as the pickup lands on the record. Very often the turntable is out of alignment and the weight of the pickup will cause the record to bind on the bottom of the slot. Warped records cause the same trouble.

Insert 2 metal washers under the rubber grommets on the mounting screws at the front of the motor board. This will raise the front of the turntable to the correct level and eliminate the trouble. Use a carpenter's level to make sure the phonograph is on an even keel.

DON TSUBOI,
Los Angeles, Calif.

... ARVIN MODEL 622

A frequent complaint on Arvin Model 622's is poor sensitivity from 900 kc to 540 kc. This is caused by poor tracking. The only remedy is to replace the oscillator coil with a high-quality unit.

EARL WASEM,
Greenville, Ill.

... FORD 1946-47 MODELS

If these models, made by Zenith, are noisy or intermittent, check the ground connections of the oscillator coil mounted on the side of the chassis. Resoldering will clear up the trouble.

WILLIAM PORTER,
Indianapolis, Ind.

UNBELIEVABLE VALUE!!

a Multi-Range VOLT-OHM MILLIAMMETER AND ALL-WAVE SIGNAL GENERATOR



BOTH FOR ONLY 34.⁸⁵



Don't pass up this amazing introductory offer! Rush your order now for this sensationally low-priced combination. Skeptical? . . . of course . . . but rush your order anyhow. We guarantee to refund your money in full if the units do not meet with your complete approval after a 10-day FREE trial.

Specifications of Model M-50

- Accurate Pocket size 1000 ohms per volt V.O.M.
- 4 A.C. VOLTAGE RANGES: 0-15/75/300/1500 volts.
- 4 D.C. VOLTAGE RANGES: 0-15/75/300/1500 volts.
- 2 D.C. CURRENT RANGES: 0-15/150 MA.
- 2 RESISTANCE RANGES: 0-10,000 ohms; 0-1 Megohm.
- Attractive modern black & white panel.
- Beautiful hand-rubbed oak case. Complete with test leads and all operating instructions.

Specifications of Model B-45

Generates RF frequencies from 150 Kc. to 50 Mc. Modulation is accomplished by grid-blocking action—equally effective for alignment of amplitude and frequency modulation as well as for television receivers. Self-contained batteries. All calibrations etched on front panel for DIRECT READING. Beautiful processed dualtone front panel in heavy gauge crystalline steel cabinet. Complete with test leads and self contained batteries.

20% deposit required on all C.O.D. orders.

MOSS ELECTRONIC DISTRIBUTING CO.

68 WESTCHESTER SQ.
Dept. RC-9 New York 61, N.Y.

RESPONSE EQUALIZATION (Continued from page 35)

When playing back, the position is quite different. Unless orthacoustic recordings are to be played, there is no low-frequency attenuation. *A* is set to 0.1 μ f (to 0.005 μ f for orthacoustic), and a bass boost is provided by setting *C* to maximum value and then adjusting *B* for the frequency at which the boost is to begin, 0.01 to 0.02- μ f being the values generally employed.

For public-address work with a good microphone, the controls are set as follows:

A to 0.005- μ f; *B*, anywhere; *C*, at minimum resistance; *D*, off; *E*, at 50 μ f; *F*, at minimum resistance or about 0.25 megohm.

The setting assumes that a good speaker is to be used and the amplifier is not being overrun. If as much intelligible sound as possible is required without regard to naturalness, then the setting is modified to:

A, at minimum capacity; *B*, anywhere; *C*, off; *D*, at from 0.0005/0.0015 μ f (middle position); *E*, at from 0.00025 μ f or 0.0006 μ f; *F*, at almost minimum resistance.

The 6 controls (and an on-off switch) are mounted on a panel 10 inches by 7 inches, and a metal case affords screening against hum. A much smaller case could have been used, but space was allowed for a power-pack.

NEW LOW PRICES

- ### SPEAKERS
- 5" P.M. Alnico 5 Magnet, \$1.09 each
 - 6 for \$6.00
 - 6" P.M. 2.15 oz. Alnico 5 Magnet, 1.69 each
 - 6 for \$9.00
- All other sizes in stock, at money-saving prices.

- ### AUTO RADIO SUPPLIES
- OZ4 TUBES, each..... 89c
 - Minimum order, 6
 - SPARK Plug SUPPRESSORS, 11
 - See our Catalog for full line of auto aeriels.

- ### PHONO SUPPLIES
- Crystal Pickup Arms..... 2.49
 - Webster No. 50 Changer..21.17
 - Webster No. 56 Changer..26.66
 - Webster No. 70 Changer..43.20
- Free \$2.50 permanent needle with each changer.

- ### Volume Controls
- 1/2 MEG. volume control with switch and long shaft, ea. 49c
 - 6 for \$2.75

- ### Money KITS Saving
- 100 Insulated Resistors, 1/2, 1 & 2 Watt..... \$1.95
 - 20 Assorted Wire Wound resistors... 1.95
 - 50 Popular Assorted Mica Condensers... 2.50
 - 20 Assorted Tube Sockets..... 1.00
 - 20 Assorted Trimmers 1.00
 - 15 ASSORTED VOLUME AND TONE CONTROLS (less switches) \$1.95
 - I.F.'s 455 KC..... 39c

- ### WIRE
- 400 ft. (approx.) of wire in assorted colors and gauges, solid & stranded in 2 to 4 feet lengths, per pkg..... 99c

CONDENSERS

Tubular Paper (600 V. Test)

Mfg.	Price Ea.	Per 100
.01	.08	\$ 6.50
.02	.08	6.50
.05	.10	8.00
.1	.12	9.00
.25	.17	13.50
.001	.08	6.50
.002	.08	6.50
.005	.08	6.50
.006	.08	6.50
.5	.26	22.50

"Illinois" Electrolytics

Mfd.	Vpc	Price Each
10	25v	.30
100	25v	.48
12	50v	.34
16	150v	.36
20	150v	.38
24	150v	.38
30	150v	.40
50	150v	.48
8	450v	.38
10	450v	.42
16	450v	.54
20	450v	.60
40	450v	.80
100	15v	.45

"Illinois" Duals

16-16	150v	.50
20-20	150v	.52
30-30	150v	.60
40-20	150v	.60
50-30	150v	.68
8-8	450v	.68
10-10	450v	.74
20-20-20	150v	.84

10% discount on all electrolytics if purchased in lots of 10 or more. Mica Condensers, all sizes, 8c each.

- ### HEAVY DUTY POWER TRANSFORMER
- Thordarson T70R62. 115V. 60 Cycle primary. Secondary 700 V.C.T. @ 145ma., 6.3V. winding @ 4.5 amps; 5V. winding @ 3 amps. Special price while limited quantity \$3.95
- Minimum Order \$3.00—20% with Order. Balance C.O.D.—WRITE FOR CATALOG. TWO CONVENIENT PLACES FROM WHICH TO ORDER. PLEASE ADDRESS DEPT. C9
- ### ELECTRONIC DISTRIBUTORS, INC.
- 620 W. Randolph St., Chicago 6, Ill

- ### 12lbs. SURPLUS ELEC-TRONIC PARTS \$2.00
- A gold mine of parts for repairmen, amateurs, and experimenters. sockets, condensers, resistors, transformers, coils, hardware, wire, etc., etc. An outstanding bargain in usable parts! Send \$2.00 cash, check or M.O. today! (Pay small express charges on receipt.)
- ### ELECTRONIC PARTS CORP.
- 436 W. State St., Milwaukee 6, Wis.

4 TREMENDOUS VALUES PROFESSIONALLY DESIGNED RADIO KITS



FM-7 complete as described

Kit Model FM-7 a Splendid, Low-priced, Self-contained Table Model Frequency Modulated Radio Receiver Kit
Complete with tubes, speaker and beautiful Bakelite cabinet. The FM-7 has a frequency response of 86-110 MC, can also be used as a TUNER with a high quality amplifier. A phono-jack is provided in the rear of the chassis with double pole, double throw switch control for feeding signal to either the radio speaker or to the phonojack. An additional jack for connecting extra loud speaker is included. The R.F. section of the kit is prefretted at the factory. This kit uses 2 I.F. stages, 1 limiter stage and 1 discriminator. Miniature tubes used throughout. Price of Model

\$29.95



Kit Model R-3 a 3-tube Receiver of the Regenerative Type

This receiver is the 110 volt type and operates at a frequency of 550 Kc to 1500 Kc by means of a plug-in coil. The power supply is self-contained in the receiver thus eliminating the need for a separate power pack. Price of Model R-3, less tubes

\$6.00



Kit Model S-5 Uses the Universally Accepted Super-heterodyne Circuit

Containing the following tubes: 12SA7, 12SK7, 12SQ7, 50L6, 35Z5 and tubes from 550 Kc to 1600 Kc. Price of Model S-5, less tubes

\$10.95



Kit Model 210 a Three Way Portable Receiver

Operating on either AC or DC or self-contained batteries... power switch conveniently located on front of set so that "battery" or "AC-DC" may be selected without opening case. Five-inch Alnico 5 permanent magnet dynamic speaker, and case covered with weather tested aircraft material. Price of Model 210 complete with tubes

\$18.95

All kits accompanied by a detailed, illustrated instruction sheet.

Many other kit models available, write for catalog M

RADIO KITS COMPANY

120 CEDAR STREET
NEW YORK 6, N. Y.

FREE

UP TO THE MINUTE
BUYING
INFORMATION

Radio Repair Parts
Sound Systems • Tools
Kits • Phono Equipment
Tubes • Test Instruments
Experimenters Supplies

**REGULAR SUPPLEMENTS
KEEP YOU POSTED**

Catalog sent immediately upon request. Price and Data Supplements, issued regularly, assure you of up-to-the-minute information—give exact and current data you need for profitable buying. Send the coupon today for this helpful buying service.

**BIG VALUES, LARGE STOCKS,
FAST, DEPENDABLE SERVICE.**

FREE... SEND TODAY

RADOLEK CO., Dept. C130
601 W. Randolph St., Chicago 6, Ill.
Please send your Free Profit Guide Catalog and regular Supplements.

Name
Address
City Zone State

SAVE AT RADOLEK

**Ever Sit On A
Gold Mine?**



YOU CAN BUILD
a business of
your own NOW—
either part or full
time—with TRA-
DIO, the radio func-
tionally designed
for coin-operation
in hotels, motels,
stopovers, hospitals,
etc. Big earnings
... Steady income
... and no clock to
punch unless you
want to.

★ **Only Small Investment
Needed**

Tradio has pioneered in this new and fast-growing industry. Get in on the ground floor and assure yourself of financial independence for life.

★ **Tradio-Tried, Tested, Proven**

Thousands of others all over the country have learned that "Tradio Pays While it Plays."

Send for complete information today.

Write to Dept. U-9



TRADIO, Inc. ASBURY PARK
NEW JERSEY

A FREAK REPAIR PROBLEM

SUBSTITUTION of components is the last desperate resource of the experienced radioman, and usually the only hope of the novice, when trying to trace an obscure fault. It is also the obvious method of verifying a suspicion. When the suspected fault is an open circuit, a temporary substitute can be connected in parallel without removing the suspected component. The most convenient way to check for open-circuited condensers, for example, is with a condenser of suitable value connected to a pair of crocodile clips. This method is generally advocated in service manuals and handbooks and may be seen in practice when visiting the service departments of famous radio manufacturers.

The writer's faith in this established practice recently had a severe setback. Motorboating had developed in a well-known radio-phonograph. It was quickly isolated to the double-diode-triode circuit. All the decoupling condensers, with the exception of the electrolytic cathode by-pass condenser, were eliminated by the established method, using a 1- μ f condenser and crocodile clips.

Grid bias was normal. Therefore, if the cathode condenser was defective, it must be open-circuited and not short-circuited. A suitable electrolytic condenser was selected. Its short leads were connected direct to the clamping screws of a pair of crocodile clips (which, incidentally, were comparatively new and of clean appearance.)

The new condenser was clipped in place across the suspect and made no apparent difference in either the volume or frequency of motorboating. This caused some surprise, and a new reading was taken across the bias resistance. It again showed correct bias voltage (while taking this reading the motorboating was stopped temporarily by shorting the triode grid to chassis). Wrong diagnosis was assumed and time was wasted endeavoring to trace the fault elsewhere. The electrolytic condenser still seemed to be the source of trouble, and, though it was obviously not short-circuited, it was removed and the new one (still connected to its crocodile clips) clipped into place. New points of attachment were selected since the previous ones—the leads of the old condenser—had been removed. The motorboating, however, persisted with unchanged vigor. The original condenser being 8 years old and still regarded with half-suspicion, the substitute condenser was removed from the clips and soldered in position, whereupon the motorboating immediately ceased. This was so surprising that it was decided to recheck. The condenser was accordingly removed, a similar one fixed to the

LCETI

crocodile clips, which were clipped into position, and the motorboating reappeared. The new substitute condenser was then soldered to the crocodile clips, which were again clipped into position, but the motorboating persisted. The ends of the crocodile clips were cleaned with carbon tetrachloride, but the motorboating persisted with unabated violence; the serrated edges were then filed bright, the clips again put into position, and the motorboating ceased.

This unusual experience is told as a warning that substitution is not 100% substitution unless a proper soldered connection is made. Ninety-nine times out of 100, or even 999 times out of 1,000, a clip connection is good enough, but it is necessary to be on the alert for the odd case. The above experience also shows that the conclusions of systematic diagnosis should not be thrown aside lightly until proved incorrect.

Experiments with the coating elsewhere on the clips showed that the skin was an excellent d.c. conductor, but acted as a rectifier to radio frequencies, presumably because of oxidization of the metal with which the devices were plated or coated. This rectification could be stopped by cleaning the surface thoroughly with a light abrasive, but rectification properties returned within 24 hours and reached a maximum in 72 hours. Unfortunately, means were not available to measure the impedance of surface contact at radio frequencies.—C. A. Quarrington, in *Practical Wireless* (London).

CORDLESS IRON

A cordless soldering iron, similar to the one described by Mr. Lanterman in the July, 1946, issue, can be converted or use with a cord if one is required.

I fitted a microphone plug into the handle of my iron and mounted a microphone jack on the top of the work bench. Another jack was mounted in the end of the envelope of an old metal tube and the cord brought out through an insulated hole in the top of the envelope. A heavy coat of insulating varnish on the exposed surface of the jack provided insulation. With this adapter, the iron can be used in any part of the shop or on outside jobs.

JACK MILLER,
Bristol, Va.

CHARGER KINK

Defective Tungar and Rectigon charger bulbs often can be restored to active service if the filament is in good condition. These bulbs have a plate and filament in parallel planes. With use, the filament sags away from the plate and charging ceases.

Turn the bulb on its side so that the filament is above the plate, and strike the upper surface of the bulb with the hand. Test the bulb in the charger and strike several more times if necessary. This sharp tapping often jars the filament back in place. Sometimes the filament breaks, but usually many additional hours of service can be obtained.

H. A. NICKERSON,
Boston, Mass.

NAVY RECEIVER \$29⁵⁰

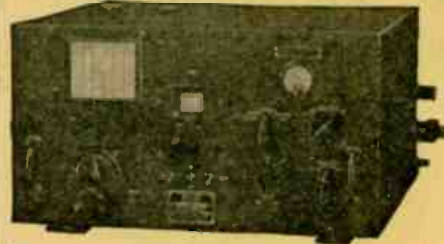

MODEL DP 12

War surplus Navy direction finder is a 12-tube superhot receiver that makes a swell broadcast receiver at an astonishingly low price. Covers frequency ranges from 100 to 1500 KC. Price includes receiver and pedestal, less tubes and power supply. This unit may be used as a radio direction finder, or as a broadcast receiver. Uses following tubes: 4-6D6; 4-6C6; 2-76; 1-5Z3; 1-6AF6G. An instruction manual is included. Your cost, \$29.50. Approx. Weight 100 lbs.



Almo Radio Co.
509 Arch St., Phila., Penna.

SUPREME PUBLICATIONS

New 1947 Radio DIAGRAM MANUAL

Most - Often - Needed

1947

RADIO DIAGRAMS

and Servicing Information

Compiled by
M. N. BEITMAN

SUPREME PUBLICATIONS
CHICAGO, ILL.

Only
\$2⁰⁰

GET ALL 7 VOLUMES NOW

Amazing Bargain Offer

Speed up and simplify all radio repairs with the inexpensive SUPREME Manuals. Service radios faster, better, easier, save money and time, use these most-often-needed diagram manuals to get ahead and earn more per hour. At unbelievable low cost (only \$2 for most volumes) you are assured of having in your shop and on the job, needed diagrams and other essential repair data on 4 out of 5 sets you will ever service. Every popular radio of every make, from old-timers to new 1947 sets, is included. Clearly printed circuits, parts lists, alignment data, and helpful service hints are the facts you need to improve your servicing ability. Save hours each day, every day, let these seven volumes furnish diagrams for 80% of all sets. See pictures of these attractive manuals above. Each volume has between 192 and 240 pages, large size 8½ x 11 inches. Manual style binding. Get these manuals at your jobber or send coupon.

NO RISK TRIAL ORDER COUPON

SUPREME PUBLICATIONS, 9 S. Kedzie Ave., Chicago 12, ILL.

Ship the following manuals: (Money back guaranteed)

1947 1946 1942 1941 1940 1939] 1926-1938
 Price each volume only \$2.00, postpaid] \$2.50

I am enclosing \$..... send postpaid.

Send C.O.D. I am enclosing \$..... deposit.

Name:

Address:

(Send coupon or write order in a letter)

Don't forget
to refer to the
RADIONIC
Catalog!

... BECAUSE IT'S ONE
COMPLETE COMPREHENSIVE
RELIABLE VOLUME

PARTS AND ACCESSORIES • TEST INSTRUMENTS
• RADIOS • TELEVISION COMPONENTS
• INTER-COMMUNICATORS • RECORDERS
• PUBLIC ADDRESS TUBES • HARDWARE
• RECORD CHANGERS • TECHNICAL BOOKS

Chancellor Radio

RADIONIC
EQUIPMENT COMPANY

DEPT. 109 TRIBUNE THEATRE ENTRANCE WORTH
170 NASSAU ST., N. Y. 7 N. Y. 2-0421
CABLE "CHANSLOC"

Radionic Equipment Co., Dept. 109
170 Nassau Street
New York 7, N. Y.

Please send me a FREE copy of your 1947 Catalog. I understand it has thousands of items illustrated, described and priced and will be a great help to me in my search for "hard-to-find" radio equipment, CHANCELLOR Portable and Phono Radios.

Name
Address
City State

MAIL TODAY

"TIK" for KITS

Servicemen • Amateurs • Jobbers

Look at these values

Mica Condensers, Assorted	100 for	\$3.49
Allen Bradley, etc., Volume Controls	50 ohm, to 1 meg	\$2.59
Carbon Resistors, Color Coded,	100 for	\$2.50
1/2, 1 & 2 Watt		
Wire Wound Resistors, Ward Leonard,	etc. 5 to 75 Watt	\$2.98
Fuses, Buss & Littelfuse	100 for	\$1.89
Assorted Oil filled condensers, tubular and bath tube type, 400 V, 600 V, 1000 Volts	12 for	\$2.49
Octal and 4 prong Ceramic Sockets (without rings)	100 for	\$3.98
Condensors .05 mfd, 2,000 volt to .25 mfd 3,000 WVDC	6 for	\$3.59
Precision Wire Wound Resistors, Shallcross, Mepco, etc., 1/4, 1/2 and 1 Watt	15 for	\$2.98

SPECIAL COMBO KIT

OUR INTRODUCTORY OFFER
Excellent Assortment

Big Value
Tremendous Savings

This kit includes a quantity of items listed in the above kits, PLUS many others. It's our New Customer Special. **\$10.98**

Minimum order \$2.00
25% deposit required on all C.O.D. orders.
Add postage Write Dept. RCS

"TIK" 55 WALKER ST.,
NEW YORK 13, N. Y.
phone CAnal 6-7485

Communications

CAN'T STAND THE SHOCK!

Dear Editor:

A friend of mine decided to renew the ground wire from his a.c. radio to outside earth. The set was plugged in but was switched off. While working with the wire he touched the ground connection on the set with one hand and the outside earth wire with the other. He received a heavy shock through arms and body. This puzzled me, but not knowing all about the situation, I assumed that some partial short or leakage might be causing the trouble.

Last week I myself received a heavy a.c. shock under identical circumstances. I could not at first understand how it was possible for the current to get through with the set switched

off. A neon tester showed a definite leak, but the power transformer windings showed no d.c. leakage to core.

Experiment proved that the trouble arose only when the plug was inserted in the wall so that the hot wire of the line came straight through to the transformer instead of to the switch. The a.c. was using the transformer as a large condenser, and the core was on one side of it. When the set was switched on, there was no leak, and the set worked perfectly.

This may interest readers who have had similar experiences.

J. F. HOLLIDAY,
Caversham, England

BACK TO R-C AFTER 8 YEARS

Dear Editor:

For the first time in eight years I looked at a copy of the March, 1947, issue of RADIO-CRAFT while in a drug-store. It was the cover that made me reach for the magazine.

Where I got my big surprise was in the contents. I thought I knew RADIO-CRAFT—I had read it as a kid. Now it's

a different magazine, and apparently a much better one.

To me the best article always is the most practical one. I therefore liked "The 'Scope—a Repair Tool" by Prensky and Jacobson.

Let me suggest that you do just two things:

1. Print on good paper! March issue has just eight pages of it, but it's a start.

2. Show the boys how to use test equipment! While such a statement may appear odd, you would be surprised how many take even a meter for granted, without knowing what's inside.

Please compliment the authors Prensky and Jacobson on the excellent method of presentation they use.

JAMES R. TRACY,
Jefferson City, Mo.

LIKES TEST EQUIPMENT

Dear Editor:

Your editorial in the March issue was especially interesting to me as I am studying radio and am writing the City and Guilds Radio Exams (London) every year.

I particularly like the articles on building test instruments and receivers, but have difficulty in procuring the necessary components here. So far I have built a regenerative receiver with resistance-coupled amplifier and an a.c.-d.c. superheterodyne.

I am interested in a third-harmonic superhet, and want to build one as soon as I can get the parts. Have any of your readers had any experience with the circuit? Is it superior to the ordinary superhet or not, and what are its advantages and disadvantages?

I hope you will continue to have "Transatlantic News" by Major Ralph Hallows, as it is especially interesting here to see how the English and American methods differ.

J. E. DEKLERK,
Natal, South Africa

Get a new UNGAR
ELECTRIC SOLDERING IRON

FREE

... and assemble your own
MAGI-KLIPS

Radio & Electronic Experimenter's Kit



This is the same MAGI-KLIPS Kit—complete with all parts—that we sell ready assembled for \$29.75.

In knocked-down form with full instructions for assembly, it is now available at the new low price—

\$19.75

... complete with an Ungar Electric Soldering Iron—the ideal iron for wiring your unassembled MAGI-KLIPS Kit.

Remember, you build 18 different experiments with your MAGI-KLIPS Kit. You actually teach yourself radio and electronics and have a lot of fun at the same time.

RADIO RECEIVER, HOME BROADCASTER, PHOTO-ELECTRIC RELAY, CODE PRACTICE OSCILLATOR, SIGNAL TRACER, REMOTE CONTROL RELAY, Phonograph Transmitter, Intercommunication Amplifier, Code Transmitter, Radio Frequency Oscillator, Telephone Line Amplifier, Electronic Switch, Phonograph Amplifier, Temperature Control Relay, Contact Detector, Electronic Metronome, Interval Timer (one-shot), Interval Timer (repeating).

Send for your copy of FREE booklet, "Electronics Made Easy."

DEER & TAYLOR COMPANY
Dept. C 1340 Milvia St. Berkeley 9, Calif.

These Prices for U. S. A. Only — Send Postal or Money Orders Only — 25% Deposit on C. O. D's.

MOTOR GENERATOR

110 V DC - 110V AC - 25 KVA

Only **\$65.00**

F.O.B. N.Y.C.
Shipping Wt. 250 lbs.

IDEAL FOR RADIO AND TELEVISION WORK. FILTERED AT BOTH ENDS.

BINDING POSTS

Brass — Silver plated, Screw type. Base 10/32 Tbd.

\$1.00 per Dozen 75c per Doz. in 5 Doz. lots.

WILLARD 2-VOLT STORAGE BATTERY

Exact replacement for GE portables—brand new.

Each.. \$2.25
Add 25c west of the Mississippi.

ULTRA MAGNET

LIFTS MORE THAN 20 TIMES ITS OWN WEIGHT.

Lifts 5 lbs. easily. Weighs 1 1/2 oz. Made of ALNICO new high-magnetic steel. Hundreds of excellent uses. Measures 1 3/4"x1 1/2". Ship. wgt. 3/4 lbs. **\$1.25 ea.**

ANTENNA A-27 (PHANTOM)

This dummy antenna is designed to approximate the characteristics of the mast antenna as far as the tuning and loading of the transmitter are concerned. It is to be used when it is necessary to keep the transmitter on for extended periods of time, whether for pre-setting, alignment, or service work.

A chart on the side of this antenna box is used to log, for each 100-ko division, the setting of its control at which it offers the best loading to the radio transmitter **\$2.00**

GE Dial Belt Kits Needle Packet Alignment Kit-Inspection Lite

G-C SERVICEMEN'S DIAL BELT KITS
Fine woven replacement for all sets. Easy to install. Supplied in kits of various quantities, with steel box. No. G-2—Kit of 25 belts—List \$6.70

G-C SERVICEMEN'S PHONO NEEDLE PACKET
For every serviceman to carry on calls. Sell needle replacements with this handy packet. Contains ten needles, two each type and two recording stylus. No. 1432..... List \$8.50

G-C INSPECTION LITE
Ideal for servicing. Lights up hard-to-see corners. Perfect for repairmen, experimenters, etc. 110-120 AC-DC No. 705..... List \$1.50

G-C NO. 5025 PROFESSIONAL ALIGNMENT KIT
Complete alignment and neutralizing kit in steel box. Has every tool to service any set; 30 tools. List \$19.95

SOLD BY ALL JOBBERS!
Write for complete catalog!
RADIO DIVISION DEPT. D
GENERAL CEMENT Mfg. Co., Rockford, Ill., U.S.A.
Manufacturers of over 3,000 products
Sales offices in principal cities

ROBOT MAKES RADIOS

(Continued from page 21)

- (4) A very small labor force is required. Each E.C.M.E. machine needs only 2 semiskilled operatives. A foreman-electrician can supervise several machines. Manual assembly consists merely in plugging in the larger components.
- (5) The ordinary radio may contain hundreds of soldered joints, each one a potential source of trouble. In the E.C.M.E. set there are very few joints, the great majority of conductors being integral with the components to or from which they lead. The few soldered joints are clinched as well.
- (6) E.C.M.E. equipment is lighter, more rugged, and more compact than that containing wired connections and prefabricated components such as resistors and capacitors.
- (7) Since the bulk of the components used are made simultaneously and automatically in the machine, very few need be bought or made separately. Alterations in design can be made without having to scrap large stocks of expensive components.

This revolutionary new method of radio assembly is the first serious and successful attempt by Sargrove to produce radio apparatus by a completely mechanical process and it well may be adopted ultimately by all manufacturers for mass production.

THE BEST in SURPLUS

- Dynamotor DM-30 24V. Input.....ea. \$1.50
- Miniature headphones, with H'Band, Cord.....ea. 1.00
- Tubes 6SN7, 6116, 6SA7, 6V6 New Bulk.....ea. .40
- 455 KC I.F. Transformers Special.....39c or 3 1.00
- BC-746 Tuning Unit contains plug-in rec., ant., coil tuning condenser, trans. tank coil, one 3755 crystal, one 4180 crystal complete.....ea. 1.00
- 4 Gang variable condenser 12-147 MFD.....ea. 1.00
- Cased output transformer 7000 ohm to V.C.....4 for 1.00
- Transmitter RF Chokes 2.5 MH 500 M. A.....2 for 1.00
- Power Rheostats 25 and 50 W.....2 for 1.00
- Microwitches, blade or plunger type.....3 for 1.00
- Amphenol Connector Kit, 10 male and female for.....1.00
- Weston 0-8 Milliamperes (0-60 scale) 2 1/2".....ea. 2.95
- Weston Voltmeter Switch one pole nine pos. with knob.....ea. .90
- Bakelite sheet fabric base size 40"x50" comes in 3/8 or 1/2 or 3/4 thicknesses.....lb. .50
- Circuit Breakers Heinman one amp., 110V.....ea. 1.00
- Cutter Hammer, toggles spdt.....39c or 3 for 1.00
- Resistor Kit 1/2-1-2 Watt excellent sizes.....100 for 1.95
- Potentiometer Kit all long shafts.....10 for 1.95

No Orders Under \$2.00
We Will Ship C.O.D.

KILOVOLTER TELEVISION

A Safe, Economical Source of Hi-Voltage Wt. 2 lbs. Size 4"x6"x6". Send Check, M.O. or See Dealer. Write For Folder.

\$17.95

C. B. MFG. CO.
412 W. 37 St., New York 18, N.Y.

LOW-PRICED TUNING UNIT

(Continued from page 65)

a booklet distributed with the set. Installation data is printed on the back cover of the cabinet, and a schematic and aligning data are fastened on the underside of the top of the cabinet. The set's construction is clean and rugged, with all components placed where they can be adjusted easily or replaced when necessary. In tests using the built-in antenna in downtown Manhattan the set showed no evidence of tuning drift. It had good noise rejection and there was no difficulty in separating 2 powerful stations separated by only 2 channels.

THE HEATH COMPANY

BENTON HARBOR, MICHIGAN

EASY TO LEARN CODE

It is easy to learn or increase speed with an Instructograph Code Teacher. Affords the quickest and most practical method yet developed. For beginners or advanced students. Available tapes from beginner's alphabet to typical messages on all subjects. Speed range 5 to 40 WPM. Always ready—no QRM.

ENDORSED BY THOUSANDS!
The Instructograph Code Teacher literally takes the place of an operator-instructor and enables anyone to learn and master code without further assistance. Thousands of successful operators have "acquired the code" with the Instructograph System. Write today for convenient rental and purchase plans.

INSTRUCTOGRAPH COMPANY

4701 Sheridan Rd., Dept. RC, Chicago 40, Ill.

NO SURPLUS REGRETS

When you buy from

Mission Radio Inc.

We stock the products of leading manufacturers of radio parts for immediate delivery.



POLYMER V.T.V.M.

MODEL #134 FOR R.F. TO 300 M.C.
NET \$69.50



\$79.50 net



SYLVANIA TEST EQUIPMENT
Model #139 Illustrated
Portable Model #140
\$79.50 net

OSCILLOSCOPE
3" scope Model #131
Gray crackle finish. NET \$78.50

All orders shipped within 4 hours of receipt. 20% deposit required on all mail orders.

MISSION RADIO INC.

216 S. Prasa Street San Antonio, Texas

RADIO SERVICE KITS

all NEW parts STANDARD BRANDS only
we are **DEPENDABLE**

- #101—VOLUME CONTROLS—25 asstd carbon & wv; 5 ohms-1 meg \$4.95
 - #102—TUBE SOCKETS—40 asstd wafer-moulded-ceramic-mica 4 to 8 Prong 2.95
 - #103—MICA CONDENSERS—100 asstd .00001 to .01mfd/300-600 V 4.95
 - #104—CIRCUIT SELECTOR SWITCHES—25 asstd (2 to 24 positions) 6.25
 - #105—WIREWOUND RESISTORS—40 asstd fixed & adjustable; 5 to 100 watts 6.95
 - #106—"AG" SWITCHES—15 asstd Tokles-Rotary-Flash-Micro-Thermo 4.45
 - #107—PRECISION RESISTORS—200 asstd carbon & wv; 6 ohm to 10.0 megs; ¼ to 2% tolerance 14.95
 - #108—CARBON RESISTORS—100 asstd 1 ohm to 10.0 megs; ½ & 1 watt 2.50
 - #109—DUAL POTENTIOMETERS—10 asstd carbon & wv; 20 ohms to 2.0 megs 5.95
 - #110—POWER RHEOSTATS—10 asstd 10 ohms to 15,000 ohms; 25 watts 7.50
 - #111—ELECTROLYTIC CONDENSERS (tin cans) 20 asstd; 4 mfd-2500 mfd/10-600 V 9.95
 - #112—BY-PASS CONDENSERS—60 asstd .0005 to .5 mfd/200 to 600 volts 2.95
 - #113—KNOBS—50 asstd Bar, Pointer, Instrument, Panel, etc. 3.95
- ALSO: Westinhouse and GE METERS 0-1 ma DC; 3" square, 1000 ohms per volt 3.95
60" VOLTMETER TEST LEADS (Muel-ler): Banana plugs & alligator (rub-ber covered) clips; red & black leads .95

EVERY RADIO "HANDYMAN" NEEDS THESE BASIC KITS! A KIT FOR EVERY PURPOSE!

25% deposit required on all orders. Add 25c for postage and handling

ALAMO RADIO SALES

Dept. R.C., 161 Washington St., NYC 6, N. Y.

General Electric National Union and Tung-sol

RECEIVING TUBES

50= 10=2% DISCOUNT
SPECIALS THIS MONTH

Raytheon OZ4, Metal 74c—10 for \$7.00
5" PM Alnico Speakers \$1.22—10 for \$11.50
6" PM Alnico Speakers \$1.90—10 for \$17.50

Write for our **FIRST ANNIVERSARY FLYER . . .**

CENTRAL ELECTRONIC SUPPLY COMPANY, INC.

203 W. 4TH STREET

OWENSBORO, KENTUCKY

INDEX TO ADVERTISERS

Abell Distributing Company	61	McMurdo Silver Company	67
Brodix Advertising Agency		Edward Owen & Company	
Alamo Radio Sales	82	Mission Radio, Inc.	48, 82
Altomari Advertising Agency		Moss Electronic Distributing Company	77
Allied Radio Corporation	62	Bass & Company, Inc.	
George Brodys Advertising		Murray Hill Books, Inc.	52, 56, 63
Almo Radio Company	79	Harry P. Bridge Advertising	
E. L. Brown Advertising		National Company, Inc.	6
American Sales Company	64	John A. Cairns & Co., Inc.	
American Television, Inc.	11	National Radio Institute	1
Turner Advertising Agency		Van Sant, Dugdale & Co.	
Amplifier Corporation of America	53, 60, 66	National Schools	9
H. J. Gold Advertising		The Mayers Company	
Apex Video Company	55	Newark Electric Company, Inc.	74
Anderson & McConnell Advertising		Bergman-Jarrett Company	
Walter Ashe Radio Company	71	Niagara Radio Supply	60
Ralph W. Smith Advertising Agency		Bergman-Jarrett	
Audel Publishers	83	Ohmite Manufacturing Company	50
Grant & Wadsworth, Inc.		The Fensholt Company	
Bell Telephone Labs.	39	Olson Radio Warehouse	48
N. W. Ayer & Son		Jessop Advertising Company	
Bonafide Radio Company	76	Opportunity Adlets	56
Sternfield-Godley		Pa-Kette Radio Company	48
Boland & Boyce	72	Arrow Advertising Agency	
Shappe-Wilkes, Inc.		Potter Radio Company	64
Brooks Radio Distributing Company	75	Precision Apparatus Company	56
Equity Advertising Agency		Shappe-Wilkes, Inc.	
Buffalo Radio Supply	45	Progressive Electronics Company	47
International Advertising Agency		Thomson, Sava & Valenti, Inc.	
Burstein-Appelbee Company	75	Pyramid Electric Co.	Back Cover
Frank E. Whalen Advertising Company		Arnold Cohen Advertising Agency	
Buyers' Syndicate	64		
C. B. Manufacturing Company	81		
C. F. Cannon	48		
M. J. Werner Advertising			
Capitol Radio Engineering Institute	43		
Henry J. Kaufman & Associates			
Central Electronic Supply Company	82		
Cleveland Institute of Radio Electronics	13		
Kenneth Kolpein Advertising			
Communications Equipment Company	12		
Borough Advertising Agency			
Concord Radio Corporation	65		
E. H. Brown Advertising			
Coyne Electrical School	73		
Gordon Best Company, Inc.			
Coyne Electrical School	58		
Phil Gordon Advertising Agency			
Deer & Taylor	80		
Spencer W. Curtiss Advertising			
DeForest's Training Institute	7		
Lausen & Salomon			
Douglas Radio Supply Company	74		
Dynamic Television Associates, Inc.	61		
Bergman-Jarrett Company			
Eaton's	55		
Electronic Distributors, Inc.	77		
Campbell, Reynolds & Evans			
Esse Radio Company	14, 15		
General Cement Mfg. Company	81		
Sander Rodkin Advertising			
General Electronic Distributing Company	41		
Bass & Company, Inc.			
General Test Equipment Company	66		
Suzanne Hayman Advertising			
Hallicrafters Company	Inside Front Cover		
Burton Browne, Inc.			
The Heath Company	81		
Norman W. Henley Publishing Company	71		
Hershel Radio Company	58		
Hugh-Allen Company			
Highbridge Radio-Television & Appliance Co.	66		
Bergman-Jarrett			
Holland Hardware	81		
Altomari Advertising Agency			
Instructograph Company	81		
Turner Advertising Agency			
Katolight Company	53		
Lafayette Radio	66, 68		
Reiss Advertising Agency			
Lake Radio Sales Company	73		
Sander Rodkin Advertising Agency			
Leeds Radio Company	64		
Weber Associates			
Leotone Radio Corporation	68		
Altomari Advertising Agency			
Lyell Hardware Company	70		
P. R. Mallory & Co., Inc.	Inside Back Cover		
Aitkin-Kynett Company			
Maedel Publishing House	83		
Maritime Switchboard	62		

RADIO SCHOOL DIRECTORY (See Page 84)

American Radio Institute	
Sternfield-Godley, Inc.	
Baltimore Technical Institute	
Candler System Company	
Rand-Ries Advertising	
Commercial Radio Institute	
Don Martin School of Radio Arts	
Eggert Radio Institute	
Gunn-Mears Advertising Agency	
Hollywood Sound Institute	
Nelson Advertising Service	
Lincoln Engineering School	
Buchanan-Thomas Advertising	
Melville Radio Institute	
Seidell Advertising	
Milwaukee School of Engineering	
Klau-Van Pietsoren-Dunlap Associates	
Radio Television Institute	
Richmond Advertising Service	
RCA Institutes	
Tri-State College	
Clem J. Steigmeyer	

Radio Center	57
Claude E. Whipple Advertising	
Radio-Graft Library Series	69
Radio Dealers Supply Company	70
Radio Kits Company	78
Hamburger Agency	
Radlonic Equipment Company	64, 80
Republic Advertising Agency	
Radio Supply and Engineering Company	49
Karl G. Behr Advertising Agency	
Radolek Company	78
Campbell, Reynolds & Evans	
Reactron Company	70
Reed Manufacturing Company	75
Borg Advertising Agency	
Risco Sales Company	48
Diener & Dorskind	
The Rosicrucians	76
Richard Jorgensen	
Howard W. Sams & Company, Inc.	
George Brodsky Advertising	
Senco Radio, Inc.	73
Sternfield-Godley Advertising	
Sprague Products Company	16
Harry P. Bridge Advertising	
Sprayberry Academy of Radio	5
Harry P. Bridge Advertising	
Sterling Electronic Company	67
Sun Radio of Washington, D. C.	8
Kel Ehrlich & Merrick Advertising, Inc.	
Supreme Instruments Corporation	60
O'Callaghan Advertising Agency	
Supreme Publications	53, 79
Henry H. Teplitz Advertising	
Sylvania Electric Products, Inc.	2
Newell Emmett Company	
"TAB" Technical Apparatus Bldg.	51
Weber Associates	
Telex, Inc.	4
Campbell-Mithun, Inc.	
Tik	80
Weber Associates	
Tradio, Inc.	78
George M. Hakim Advertising	
Transvision, Inc.	44, 55
H. J. Gold Company	
Triplet Manufacturing Company	76
Western Advertising Agency	
Turner Company	59
W. D. Lyon Company	
University Loudspeakers, Inc.	54
George Homer Martin Associates	
V-M Corporation	70
X. L. Radio Laboratories	71

BOOK REVIEWS

ELECTRONICS FOR INDUSTRY, by Waldemar I. Bendz; assisted by Charles A. Scarlott. Published by John Wiley and Sons, Inc. Stiff cloth covers, 6 by 8½ inches, 501 pages. Price \$5.00.

Prepared for engineers and students whose interests lean toward industrial applications of electronics, it is presented without resorting to mathematics for an understanding of the material.

This makes reading easier and will be welcomed by those who have not a working knowledge of higher mathematics. Each of its 17 chapters concludes with a concise summary and bibliography.

The first 10 chapters are devoted to tubes—how they are made and how they are applied—with particular emphasis on industrial electronic applications. Such special purpose tubes as ignitrons, thyratrons, phototubes, cathode-ray and X-ray tubes are included. This section is well-illustrated with drawings, charts and diagrams.

The next 3 chapters cover the principles and processes of amplification, oscillation and modulation and detection. The following chapter is of particular interest to engineers working with high-frequency heating equipment. A sufficient amount of material is presented to enable an engineer to design either induction or dielectric heating equip-

ment to exacting specifications. Electronic regulators are covered more thoroughly and concisely than in the average electronics text or handbook.—*R.F.S.*

MOST-OFTEN-NEEDED 1947 RADIO DIAGRAMS, and **1945-1947 POSTWAR AUTOMATIC RECORD CHANGERS**. Two books compiled by M. N. Beitman. Published by Supreme Publications. Both 8½ x 11 inches, flexible fiber covers. Radio Diagrams, 192 pages, price \$2.00; Record Changers, 143 pages, price \$1.50.

The latest of the Supreme servicing series, these two books follow the general style of their predecessors. Close examination of the Radio Diagrams indicates that more attention is being paid to servicing information than in some earlier issues, with the result that one model may occupy two pages of the book—the schematic on one and technical information on the facing page.

Record Changers carries service data on a large number of new types, and is very completely illustrated with drawings and photographs.

PHOTOELECTRIC CELLS, by A. Sommer. Published by Chemical Publishing Co. Stiff cloth covers, 5½ by 8¼ inches, 104 pages. Price \$2.75.

This book, in its entirety, is directed toward the designer and user of photoemissive tubes (phototubes) with no references to photovoltaic or photoconductive cells. It begins with a brief discussion of photoelectric emission followed by data, on characteristics, construction, and operation of phototubes. Although it contains factual information, it is doubtful that much of this is of such caliber as to be useful to the user or designer of phototubes.—*R.F.S.*

ELECTRONICS, What Everyone Should Know. By Calvin and Charlotte Mooers. Published by the Bobbs-Merrill Company. Stiff cloth covers, 5½ x 8 inches, 231 pages. Price \$2.75.

An extremely simplified account of the whole field of communications and industrial electronics, this book will fit the needs of the serious older child who finds it difficult to be patient with "for boys and girls" editions and is not yet ready for adult texts.

Beginning with a rather superficial history of the vacuum tube, the authors go on to explain how the triode works, teaching a little Ohm's Law on the way. Illustrations in this chapter appear in pictorial form, with the equivalent schematic diagram beside or beneath each pictorial.

The reader is then conducted on a tour through radio broadcasting, long-distance telephone, recording, industrial and medical electronics, radar, television, FM, radio relaying and the radio spectrum, in a chapter each. Considering the amount of ground covered in each chapter, the work is well done and the language is simple and straightforward.

READ FOR PROFIT!

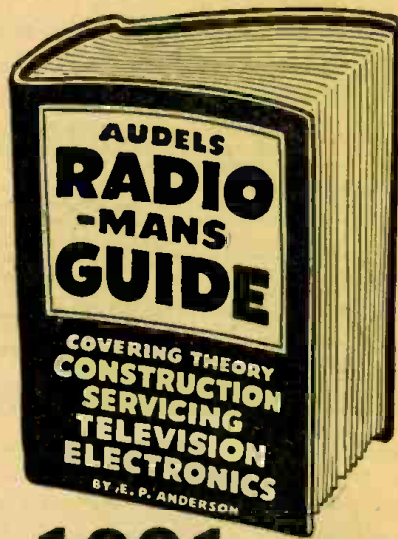

1001 RADIO FACTS AND FIGURES

AUDELS RADIOMANS GUIDE—914 Pages, 633 Illustrations, Photos, Wiring Diagrams, 38 Big Chapters, covering Radio Theory, Construction, Servicing, including Important Data on Developments in Television, Electronics and Frequency Modulation, Review, Questions and Answers, Calculations & Testing. Highly Endorsed—Indispensable for Ready Reference and Home Study.

\$4 COMPLETE • PAY ONLY \$1 A MONTH Step up your own skill with the facts and figures of your trade. Audels Mechanics Guides contain Practical Inside Trade Information in a handy form. Fully Illustrated and Easy to Understand. Highly Endorsed. Check the book you want for 7 days' Free Examination.

Send No Money. Nothing to pay postman.

CUT HERE MAIL ORDER

AUDELS, Publishers, 49 W. 23 St., NEW YORK 10, N. Y.

Please send me postpaid for FREE EXAMINATION books marked (x) below. If I decide to keep them I agree to mail \$1 in 7 days on each book ordered and further mail \$1 monthly on each book until I have paid price. Otherwise, I will return them.

- RADIOMANS GUIDE, 914 Pages . . . \$4
- ELECTRICIANS EXAMINATIONS, 250 Pages . . . 1
- WIRING DIAGRAMS, 210 Pages . . . 1
- ELECTRICAL DICTIONARY, 9000 Terms . . . 2
- ELECTRICAL POWER CALCULATIONS, 425 Pgs. . . 2
- HANDY BOOK OF ELECTRICITY, 1340 Pages . . . 2
- ELECTRONIC DEVICES, 216 Pages . . . 2
- ELECTRIC LIBRARY, 12 vol., 7000 Pgs., \$1.50 vol. . . 1
- OIL BURNER GUIDE, 384 Pages . . . 1
- REFRIGERATION & Air Conditioning, 1280 Pgs. . . 4
- POWER PLANT ENGINEERS Guide, 1500 Pages . . . 4
- PUMPS, Hydraulics & Air Compressors, 1658 Pgs. . . 4
- WELDERS GUIDE, 400 Pages . . . 1
- BLUE PRINT READING, 416 Pages . . . 2
- SHEET METAL WORKERS Handy Book, 388 Pgs. . . 1
- SHEET METAL PATTERN LAYOUTS, 1100 Pgs. . . 4
- AIRCRAFT WORKER, 240 Pages . . . 1
- MATHEMATICS & CALCULATIONS, 700 Pgs. . . 2
- MACHINISTS Handy Book, 1600 Pages . . . 4
- MECHANICAL Dictionary, 968 Pages . . . 4
- AUTOMOBILE GUIDE, 1540 Pages . . . 4
- DIESEL ENGINE MANUAL, 400 Pages . . . 2
- MARINE ENGINEERS Handy Book, 1280 Pages . . . 4
- SHIPFITTERS Handy Book, 272 Pages . . . 1
- MECHANICAL DRAWING COURSE, 160 Pages . . . 1
- MECHANICAL DRAWING & DESIGN, 480 Pgs. . . 2
- MILLWRIGHTS & Mechanics Guide, 1200 Pgs. . . 4
- CARPENTERS & Builders Guides (4 vols.) . . . 6
- PLUMBERS & Steamfitters Guides (4 vols.) . . . 6
- MASONS & Builders Guides (4 vols.) . . . 6
- MASTER PAINTER & DECORATOR, 320 Pgs. . . 2
- GARDENERS & GROWERS GUIDES (4 vols.) . . . 6
- ENGINEERS and Mechanics Guides . . . 1
- Nos. 1, 2, 3, 4, 5, 6, 7 and 8 complete . . . 12
- Answers on Practical ENGINEERING . . . 1
- ENGINEERS & FIREMANS EXAMINATIONS . . . 1

Name _____
 Address _____
 Occupation _____
 Employed by _____ R.C.P.

MATHEMATICS FOR RADIO AND COMMUNICATION

by GEORGE F. MAEDEL, A.B., E.E.

To master the technicalities of radio—to read engineering literature intelligently—you must have the mathematical groundwork covered by these absorbing books prepared for home study. Book I (314 pp.) covers the algebra, arithmetic, and geometry; Book II (329 pp.) covers the advanced algebra, trigonometry, and complex numbers necessary to read technical books and articles on radio.

MAEDEL PUBLISHING HOUSE Room 117
 593 East 38 Street, Brooklyn, New York

Send me MATHEMATICS FOR RADIO AND COMMUNICATION as checked below. I enclose payment therefor with the understanding that I may return the book(s) within 5 days in good condition and my money will be refunded.

Name _____

Address _____

- Book I at \$4.00 plus 7c postage.
- Book II at \$4.25 plus 7c postage.
- Books I and II at \$8.25 postage prepaid.

Foreign and Canadian prices 25c per volume higher.

RADIO SCHOOL DIRECTORY

PREPARE NOW FOR SKILLED JOBS IN RADIO AND ELECTRONICS

CAREERS in RADIO

INTENSIVE COURSES—Thorough, technical education for progressive men and women.

1. **RADIO TECHNICIAN**—The MRI General Course. Includes F.M. & Television. Prepares For FCC Broadcast Licenses.
2. **RADIO & TELEVISION SERVICING**—Prepares for employment as Repairman on Standard Broadcast, F.M. & Television Receivers.
3. **RADIO COMMUNICATIONS**—Prepares for FCC Operators' License. Leads to position as Merchant Marine or Flight Radio Officer, Commercial Operator.
4. **FUNDAMENTAL RADIO MATHEMATICS**—The MRI Preparatory Course. Required pre-training for students lacking a basic mathematical background.

MELVILLE RADIO INSTITUTE

MELVILLE BUILDING
15 WEST 46TH ST., N. Y. 19. BR 9-5080
"The Radio School Managed By Radio Men"

Licensed by the State of New York

MELVILLE RADIO INSTITUTE

MELVILLE BUILDING
15 West 46th St., N. Y. 19, N. Y.

GENTLEMEN: RC
Send me FREE information about your school.

Name.....

Address.....

MAIL THIS
COUPON
NOW

HERE IS TELEVISION, YOUR WINDOW TO THE WORLD, by Thomas H. Hutchinson. Published by Hastings House. Stiff cloth covers, 5½ x 8 inches, 366 pages. Price \$4.00.

Intermediate between the popular works for the laymen and those which approach television on the engineering level, this book appears to be aimed at the person who, not himself a technician or engineer, is in practical personal contact with the art, and must know something of its possibilities and limitations. It deals with studio problems from a practical point of view in Part I, goes on to programs in Part II, and devotes Part III to the commercial aspect of television production.

Television networks, theater as opposed to home television, color television and jobs in the industry have a chapter each.

The book will be most useful to producers, directors, prospective owners of and advertisers over television stations, authors, and others connected with the actual work of getting television programs on the air.

SHORT CUT  **CODE SPEED**
Be an Expert

Learn to be a Telegraph or Radio Operator. Thousands of men needed. Intensely interesting work—good pay. Learn at home or wherever you are, quickly, easily, with the famous candle Code Speed System. Book of particulars Free.

FREE BOOK

CANDLER SYSTEM CO.
Dept. 3-K, Box 928, Denver 1, Colo.

COMMERCIAL RADIO INSTITUTE

A radio training center for 27 years.

RESIDENT COURSES ONLY

Broadcast, Service, Aeronautical, Television and Marine telegraph classes. Preparatory Course now forming. Literature upon request. Veteran training. Classes now forming for October 1st. Entrance Exam, Sept. 15.

Dept. C, 38 West Biddle St., Baltimore 1, Md.



RCA INSTITUTES, Inc.

Offer thorough training courses in all technical phases of Radio and Television

DAYS—EVENINGS WEEKLY RATES

VETERANS: RCA Institutes is approved under G. I. Bill of Rights

For Free Catalog Write Dept. RC-47

RCA INSTITUTES, Inc.

A Service of Radio Corporation of America
75 VARICK STREET NEW YORK 13, N. Y.

RADIO

TECHNICIAN and RADIO SERVICE COURSES
FM and TELEVISION

AMERICAN RADIO INSTITUTE

101 West 63rd St., New York 23, New York
Approved Under GI Bill of Rights
Licensed by New York State

LEARN NOW!

ELECTRONICS

- RADIO
- F.M. and TELEVISION
- PUBLIC ADDRESS SYSTEMS
- SHORT WAVE COMMUNICATIONS

Men! Women! Find successful careers in this fascinating field! Ample equipment for all to use in practical classes. You start practice when you enroll!

Approved for Veterans

HOLLYWOOD SOUND INSTITUTE

1040 N. Kenmore Ave., Dept. B
LOS ANGELES 27, CAL.

Radio Technician and Announcers

A practical 15-month course in First Class Radiotelephone Operation and Announcing is offered by Don Martin School of Radio Arts. Most positions these days require combination men. We specialize in this type of training and maintain a placement bureau for our graduates. Serving the industry for 10 years, the School of Radio Arts can train you. Write for our catalogue outlining the courses offered. Classes can be arranged so you can do part time work on the side.

APPROVED FOR VETERANS

DON MARTIN SCHOOL OF RADIO ARTS
1655 North Cherokee St. Hollywood 28, Calif.

MEN ARE NEEDED FOR RADIO ENGINEERING FOR TELEVISION ELECTRONICS

Thorough training in radio, including fundamentals, math, repair, sales, broadcasting, communications, with modern laboratory facilities and experienced faculty.

APPROVED FOR VETERANS TRAINING

Moderate tuition and living costs
New Classes Start Each Month

Dept. 4 Albuquerque, New Mexico

EGGERT RADIO INSTITUTE



CORRESPONDENCE COURSES IN RADIO and ELECTRICAL ENGINEERING

ELECTRICAL ENGINEERING Get good grasp of wide electrical field. Prepare yourself at Low Cost for secure future. Modern course. So simplified anyone can understand quickly.

RADIO ENGINEERING Extra fine course in radio, public address, photo-electric work. Trains you to be super-service man, real vacuum-tube technician. Servicemen needed badly. Diploma on completion. Many graduates earning big pay.

Send postcard for Free Copies of school catalog, full details, all about deferred payment plan, experimental kits, etc. \$25 Either Course
Lincoln Engineering School, Box 931C-103, Lincoln 2, Nebr.

TELEVISION

Practical and Theoretical Technicians Course leads to opportunities in Industry, Broadcasting or own Business.

Day and Eve. Sessions.

Qualified Veterans Eligible.
ENROLL NOW FOR NEW CLASSES

RADIO-TELEVISION INSTITUTE

Pioneers in Television Training Since 1938
480 Lexington Ave., N.Y. 17 (46th St.)
Plaza 3-4585 Licensed by N.Y. State

PRACTICAL TECHNICAL TRAINING FOR YOU

Specialize in Electronics, Radio, Electricity, Refrigeration, Heating and Air Conditioning, or Welding. Prepare in one year for position as Technician, or in two additional years secure your B. S. Degree in ELECTRICAL ENGINEERING with major in Machinery or Electronics.

Write for booklet "Career Building"

MILWAUKEE SCHOOL OF ENGINEERING

A TECHNICAL INSTITUTE

RC-947 N. Broadway and E. State, Milwaukee, Wis.

LEARN

RADIO

Get F.C.C. License

RADIO—TELEVISION

Repairing

Classes start every month

Our organization engaged in TECHNICAL TRAINING for 27 Years

LITERATURE ON REQUEST

BALTIMORE TECHNICAL INSTITUTE

1425 Eutaw Place, Balto. 17, Md.

APPROVED FOR VETERANS

RADIO ENGINEERING!

Complete Radio Engineering Course. Bachelor of Science Degree. Courses also in Civil, Electrical, Mechanical, Chemical, Aeronautical Engineering; Business Administration, Accounting, Secretarial Science. Graduates successful. 64th year. Enter Sept., Jan., March, June. Write for catalog.

DEGREE IN 27 MONTHS

TRI-STATE COLLEGE 2486 College Ave. ANGOLA INDIANA

10 Resistance Values in Mallory Double-Tapped Controls...

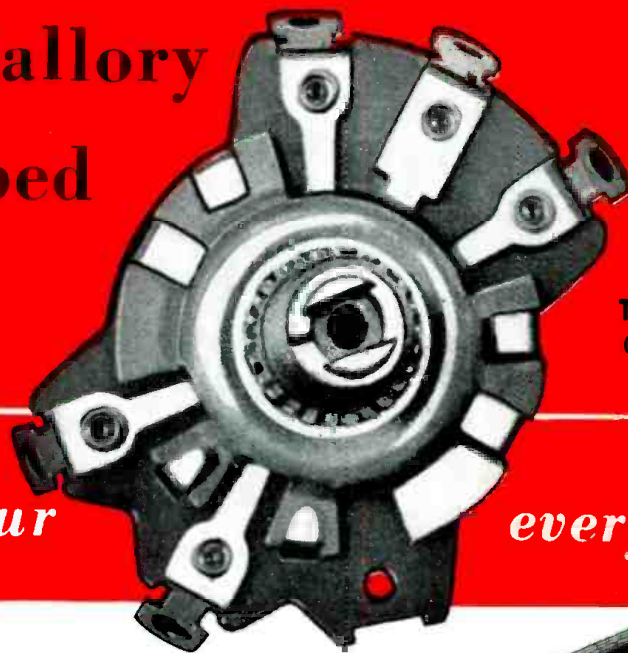

TYPE DTM
(DOUBLE TAP)

To supply your

every need

MALLORY is pretty fussy about the taper and resistance values of the controls it makes. That's because it has a thorough knowledge of controls in all original receiving sets ... conscientiously duplicates these controls with a streamlined, but *complete* line of replacements.

Mallory Double Tapped Midget Controls are a case in point. They come in ten resistance values—to supply every need! By merely combining them with the right Mallory Plug-In Shaft, you can duplicate most double tapped original controls in the "special" category.

Furthermore, Mallory provides *large* double tapped controls in four resistance values. These are to replace originals with fixed shafts of 3 inches or less.

See the Mallory Catalog for the complete story. Or contact your Mallory distributor.

You Expect More—and Get More—from Mallory



INSIST ON MALLORY— THE COMPLETE CONTROL LINE

*Mallory is the manufacturer
that offers:*

- 33 Correctly Tapered Wire-Wound Controls
- 31 Values in Single Tapped Controls
- 10 Values in Double Tapped Controls
- 12 Clutch Type Controls
- 10 Universal Dual Controls
- 92 Popular Special Controls

P. R. MALLORY & CO., Inc.
MALLORY

VIBRATORS ... VIBRAPACKS* ... CAPACITORS ... VOLUME
CONTROLS ... SWITCHES ... RESISTORS ... FILTERS
... RECTIFIERS ... POWER SUPPLIES.

*Reg. U. S. Pat. Off.

APPROVED PRECISION PRODUCTS

P. R. MALLORY & CO., Inc., INDIANAPOLIS 6, INDIANA

Save **SPACE, TIME** and **MONEY!**

with the new **PYRAMID**
"TUBE-U-LAR"
PAPER CAPACITOR

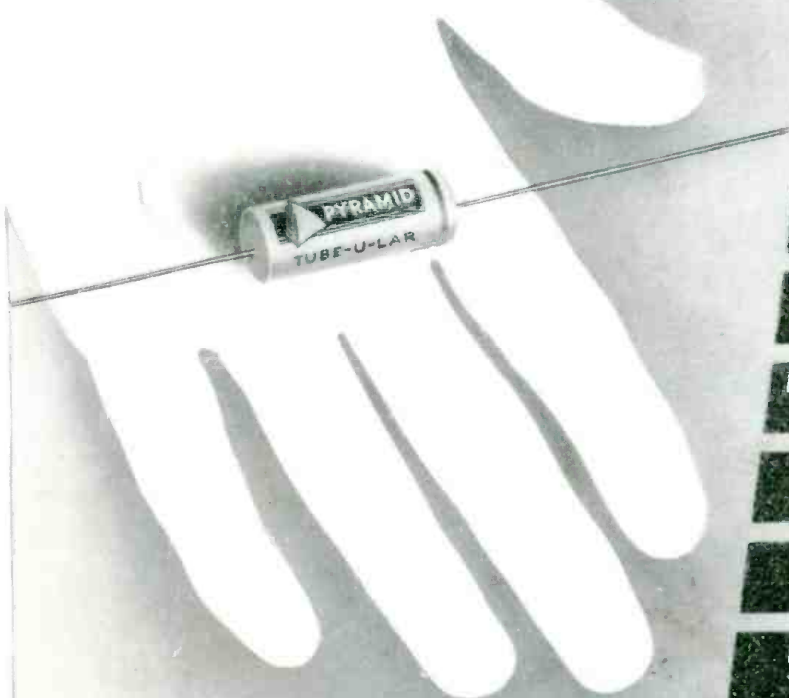

ULTRA-COMPACT

EXCELLENT QUALITY
 at modest cost

HIGH INSULATION RESISTANCE
 lengthens life

HIGH DIELECTRIC STRENGTH
 assures against breakdowns

CLEAN CONSTRUCTION
 and better appearance

LARGE, LEGIBLE MARKINGS
 make identification easy

SUPERIOR SEAL
 means dependability in all climates

PART NUMBER	CAPACITY MFD.	D.C. VOLTS WORKING	BODY SIZE, INCHES		LIST PRICE
			DIAMETER	LENGTH	
T6-D1	.001	600	3/8	1 3/8	\$.25
T6-D2	.002	600	3/8	1 3/8	.25
T6-D5	.005	600	3/8	1 3/8	.25
T6-D6	.006	600	3/8	1 3/8	.25
T6-S1	.01	600	3/8	1 3/8	.30
T6-S2	.02	600	3/8	1 3/8	.30
T6-S5	.05	600	3/8	1 3/8	.40
T6-P1	.1	600	3/8	1 3/8	.45
T6-P25	.25	600	3/8	2	.55
T6-P5	.5	600	1	2	.80



PYRAMID

"LONG-LIFE"
 PAPER & ELECTROLYTIC

Capacitors

PYRAMID ELECTRIC COMPANY

155 OXFORD STREET, PATERSON, N. J.